

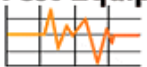

A Stitch in TIME

The Complete Guide
to Electrical Insulation
Testing

**Test Equipment
Depot**



1-800-517-8431

99 Washington Street
Melrose, MA 02176
Phone 781-665-1400
Toll Free 1-800-517-8431

Megger[®]



Visit us at www.TestEquipmentDepot.com

“A Stitch In Time”

The Complete Guide to Electrical Insulation Testing

Copyright 2006

Megger[®]

CONTENTS	PAGE
WHAT IS “GOOD” INSULATION?	3
WHAT MAKES INSULATION GO BAD?.....	4
HOW INSULATION RESISTANCE IS MEASURED	5
HOW TO INTERPRET RESISTANCE READINGS	6
FACTORS AFFECTING INSULATION RESISTANCE READINGS.....	8
TYPES OF INSULATION RESISTANCE TESTS.....	10
TEST VOLTAGE VS. EQUIPMENT RATING.....	16
AC TESTING VS. DC.....	17
USE OF DC DIELECTRIC TEST SET	18
TESTS DURING DRYING OUT OF EQUIPMENT.....	18
EFFECT OF TEMPERATURE ON INSULATION RESISTANCE.....	21
EFFECTS OF HUMIDITY	23
PREPARATION OF APPARATUS TO TEST.....	24
SAFETY PRECAUTIONS	26
CONNECTIONS FOR TESTING INSULATION RESISTANCE OF ELECTRICAL EQUIPMENT	27
ADDITIONAL NOTES ABOUT USING A MEGGER INSULATION TESTER	33
INTERPRETATION-MINIMUM VALUES	36
MINIMUM VALUES FOR INSULATION RESISTANCE.....	38
TESTS USING MULTI-VOLTAGE MEGGER INSULATION TESTERS.....	42
STEP-VOLTAGE METHOD	48
USE OF A GUARD TERMINAL.....	50
BUSHINGS, POTHEADS AND INSULATORS	54
OUTDOOR OIL CIRCUIT BREAKERS.....	57
SETTING UP A MAINTENANCE PROGRAM.....	60
HOW OFTEN SHOULD YOU TEST?.....	60
MEGGER 5 AND 10 KV INSULATION TESTERS.....	62
MEGGER 1 KV INSULATION TESTERS.....	64

WHAT IS “GOOD” INSULATION?

Every electric wire in your plant – whether it’s in a motor, generator, cable, switch, transformer, etc. – is carefully covered with some form of electrical insulation. The wire itself is usually copper or aluminum, which is known to be a good conductor of the electric current that powers your equipment. The insulation must be just the opposite from a conductor: it should resist current and keep the current in its path along the conductor.

To understand insulation testing you really don’t need to go into the mathematics of electricity, but one simple equation – Ohm’s law – can be very helpful in appreciating many aspects. Even if you’ve been exposed to this law before, it may be a good idea to review it in the light of insulation testing.

The purpose of insulation around a conductor is much like that of a pipe carrying water, and Ohm’s law of electricity can be more easily understood by a comparison with water flow. In Fig. 1 we show this comparison. Pressure on water from a pump causes flow along the pipe (Fig. 1a). If the pipe were to spring a leak, you’d waste water and lose some water pressure.

With electricity, voltage is like the pump pressure, causing electricity to flow along the copper wire (Fig. 1b). As in a water pipe, there is some resistance to flow, but it is much less along the wire than it is through the insulation.

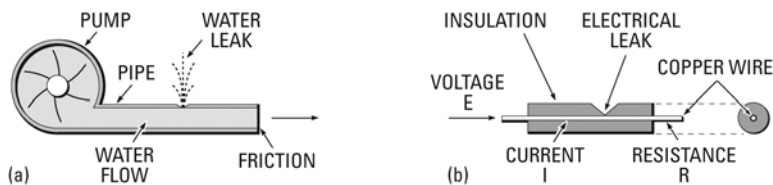

Figure 1—Comparison of water flow (a) with electric current (b).

Common sense tells us that the more voltage we have, the more current there'll be. Also, the lower the resistance of the wire, the more current for the same voltage.

Actually, this is Ohm's law, which is expressed this way in equation form:

$$E = I \times R$$

where,

E = voltage in volts
I = current in amperes
R = resistance in ohms

Note, however, that no insulation is perfect (that is, has infinite resistance) so some electricity does flow along the insulation or through it to ground. Such a current may only be a millionth of an ampere (one microampere) but it is the basis of insulation testing equipment. Note also that a higher voltage tends to cause more current through the insulation. This small amount of current would not, of course, harm good insulation but would be a problem if the insulation has deteriorated.

Now, to sum up our answer to the question "what is 'good' insulation?" We have seen that, essentially, "good" means a relatively high resistance to current. Used to describe an insulation material, "good" would also mean "the ability to keep a high resistance." So, a suitable way of measuring resistance can tell you how "good" the insulation is. Also, if you take measurements at regular periods, you can check trends toward its deterioration (more on this later).

WHAT MAKES INSULATION GO BAD?

When your plant electrical system and equipment are new, the electrical insulation should be in top notch shape. Furthermore, manufacturers of wire, cable, motors, and so on have continually improved their insulations for services in industry. Nevertheless, even today, insulation is subject to many effects which can cause it to fail – mechanical damage, vibration, excessive heat or cold, dirt, oil, corrosive vapors, moisture from processes, or just the humidity on a muggy day.

In various degrees, these enemies of insulation are at work as time goes on – combined with the electrical stresses that exist. As pin holes or cracks develop, moisture and foreign matter penetrate the surfaces of the insulation, providing a low resistance path for leakage current.

Once started, the different enemies tend to aid each other, permitting excessive current through the insulation.

Sometimes the drop in insulation resistance is sudden, as when equipment is flooded. Usually, however, it drops gradually, giving plenty of warning, if checked periodically. Such checks permit planned reconditioning before service failure. If there are no checks, a motor with poor insulation, for example, may not only be dangerous to touch when voltage is applied, but also be subject to burn out. What was good insulation has become a partial conductor.

HOW INSULATION RESISTANCE IS MEASURED

You have seen that good insulation has high resistance; poor insulation, relatively low resistance. The actual resistance values can be higher or lower, depending upon such factors as the temperature or moisture content of the insulation (resistance decreases in temperature or moisture). With a little record-keeping and common sense, however, you can get a good picture of the insulation condition from values that are only relative.

The Megger insulation tester is a small, portable instrument that gives you a direct reading of insulation resistance in ohms or megohms. For good insulation, the resistance usually reads in the megohm range.

The Megger insulation tester is essentially a high-range resistance meter (ohmmeter) with a built-in direct-current generator. This meter is of special construction with both current and voltage coils, enabling true ohms to be read directly, independent of the actual voltage applied. This method is non-destructive; that is, it does not cause deterioration of the insulation.

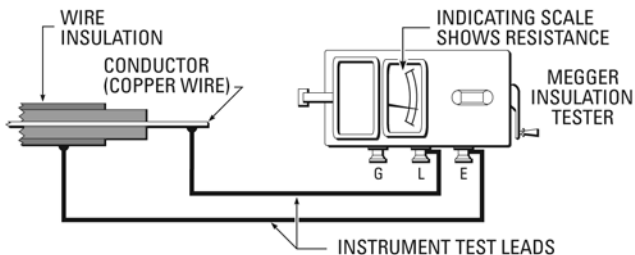

Figure 2—Typical Megger test instrument hook-up to measure insulation resistance.

The generator can be hand-cranked or line-operated to develop a high DC voltage which causes a small current through and over surfaces of the insulation being tested (Fig. 2). This current (usually at an applied voltage of 500 volts or more) is measured by the ohmmeter, which has an indicating scale. Fig. 3 shows a typical scale, which reads increasing resistance values from left up to infinity, or a resistance too high to be measured.

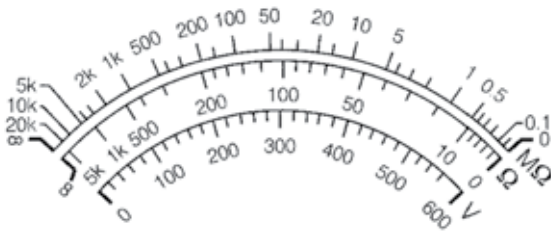

Figure 3—Typical scale on the Megger insulation tester.

HOW TO INTERPRET RESISTANCE READINGS

As previously mentioned, insulation resistance readings should be considered relative. They can be quite different for one motor or machine tested three days in a row, yet not mean bad insulation. What really matters is the trend in readings over a time period, showing lessening resistance and warning of coming problems. Periodic testing is, therefore, your best approach to preventive maintenance of electrical equipment, using record cards as shown in Fig. 4.

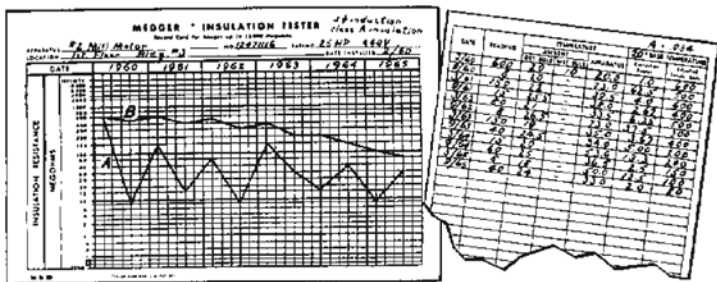

Figure 4—Typical record of insulation resistance of a mill motor. Curve A shows test values as measured; Curve B shows same values corrected to 20°C (see page 22), giving a definite downward trend toward an unsafe condition. Reverse side of card (at right) is used to record the test data.

Whether you test monthly, twice a year, or once a year depends upon the type, location, and importance of the equipment. For example, a small pump motor or a short control cable may be vital to a process in your plant. Experience is the best teacher in setting up the scheduled periods for your equipment.

You should make these periodic tests in the same way each time. That is, with the same test connections and with the same test voltage applied for the same length of time. Also you should make tests at about the same temperature, or correct them to the same temperature. A record of the relative humidity near the equipment at the time of the test is also helpful in evaluating the reading and trend. Later sections cover temperature correction and humidity effects.

In summary, here are some general observations about how you can interpret periodic insulation resistance tests, and what you should do with the result:

Condition	What To Do
(a) Fair to high values and well maintained.	No cause for concern.
(b) Fair to high values, but showing a constant tendency towards lower values.	Locate and remedy the cause and check the downward trend.
(c) Low but well maintained.	Condition is probably all right, but cause of low values should be checked.
(d) So low as to be unsafe.	Clean, dry out, or otherwise raise the values before placing equipment in service. (Test wet equipment while drying out.)
(e) Fair or high values, previously well maintained but showing sudden lowering.	Make tests at frequent intervals until the cause of low values is located and remedied; or until the values have become steady at a lower level but safe for operation; or until values become so low that it is unsafe to keep the equipment in operation.

FACTORS AFFECTING INSULATION RESISTANCE READINGS

Remember that the measured resistance (of the insulation) will be determined by the voltage applied and the resultant current ($R = E/I$). There are a number of things that affect current, including temperature of the insulation and humidity, as mentioned in the previous section. Right now, let's just consider the nature of current through insulation and the effect of how long voltage is applied.

Current through and along insulation is made up partly of a relatively steady current in leakage paths over the insulation surface. Electricity also flows through the volume of the insulation. Actually, as shown in Fig. 5, our total current comprises three components:

1. Capacitance Charging Current

Current that starts out high and drops after the insulation has been charged to full voltage (much like water flow in a garden hose when you first turn on the spigot).

2. Absorption Current

Also an initially high current which then drops (for reasons discussed under the section Time-Resistance Method).

3. Conduction or Leakage Current

A small essentially steady current both through and over the insulation.

As shown in Fig. 5, the total current is the sum of the three components and it is this current that can be measured directly by a microammeter, or in terms of megohms at a particular voltage by means of a Megger instrument (ohmmeter). Because the total current depends upon the time that the voltage is applied, you can see now why Ohm's Law $R = E/I$ only holds, theoretically, at an infinite time (that is, you'd have to wait forever before taking a reading).

In practice, as you will see in the test methods described below, you read a value that is the apparent resistance – a useful value to diagnose troubles, which is what you want to do.

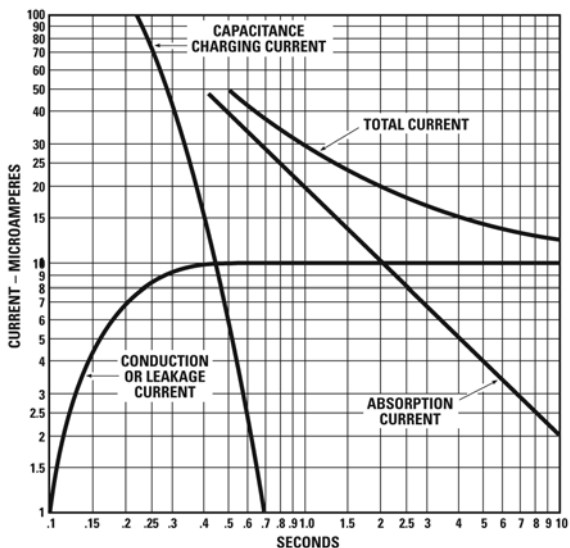

Figure 5—Curves showing components of current measured during DC testing of insulation.

Note also in Fig. 5 that the charging current disappears relatively rapidly as the equipment under test becomes charged. Larger units with more capacitance will take longer to be charged. This current also is the stored energy initially discharged after your test, by short-circuiting and grounding the insulation. **ALWAYS TAKE THIS SAFETY MEASURE.**

You can see further from Fig. 5 that the absorption current decreases at a relatively slow rate, depending upon the exact nature of the insulation. This stored energy, too, must be released at the end of a test, and requires a longer time than the capacitance charging current – about four times as long as the voltage was applied.

With good insulation, the conduction or leakage current should build up to a steady value that is constant for the applied voltage, as shown in Fig. 5. Any increase of leakage current with time is a warning of trouble, as discussed in the tests described in the following section.

With a background now of how time affects the meaning of instrument readings, let's consider three common test methods: (1) short-time or spot reading; (2) time-resistance; and (3) step or multi-voltage tests.

TYPES OF INSULATION RESISTANCE TESTS

Short-Time or Spot-Reading Test

In this method, you simply connect the Megger instrument across the insulation to be tested and operate it for a short, specific time period (60 seconds is usually recommended). As shown schematically in Fig. 6, you've simply picked a point on a curve of increasing resistance values; quite often the value would be less for 30 seconds, more for 60 seconds. Bear in mind also that temperature and humidity, as well as condition of your insulation affect your reading.

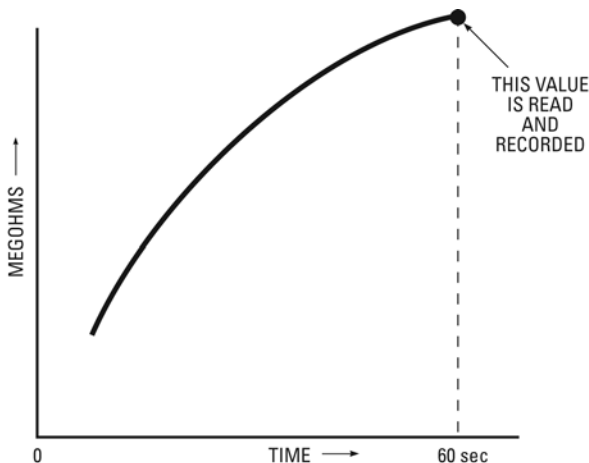

Figure 6—Typical curve of insulation resistance (in megohms) with time for the “short time” or “spot-reading” test method.

If the apparatus you are testing has very small capacitance, such as a short run of house wiring, the spot reading test is all that is necessary. However, most equipment is capacitive and so your very first spot reading on equipment in your plant, with no prior tests, can be only a rough guide as to how good or bad the insulation is. For many years, maintenance professionals have used the one-megohm rule to establish the allowable lower limit for insulation resistance. The rule may be stated:

Insulation resistance should be approximately one megohm for each 1,000 volts of operating voltage, with a minimum value of one megohm.

For example, a motor rated at 2,400 volts should have a minimum insulation resistance of 2.4 megohms. In practice, megohm readings normally are considerably above this minimum value in new equipment or when insulation is in good condition.

By taking readings periodically and recording them, you have a better basis of judging the actual insulation condition. Any persistent downward trend is usually fair warning of trouble ahead, even though the readings may be higher than the suggested minimum safe values. Equally true, as long as your periodic readings are consistent, they may be ok, even though lower than the recommended minimum values. The curves of Fig. 7 show typical behavior of insulation resistance under varying plant operating conditions. The curves were plotted from spot readings taken with a Megger instrument over a period of months.

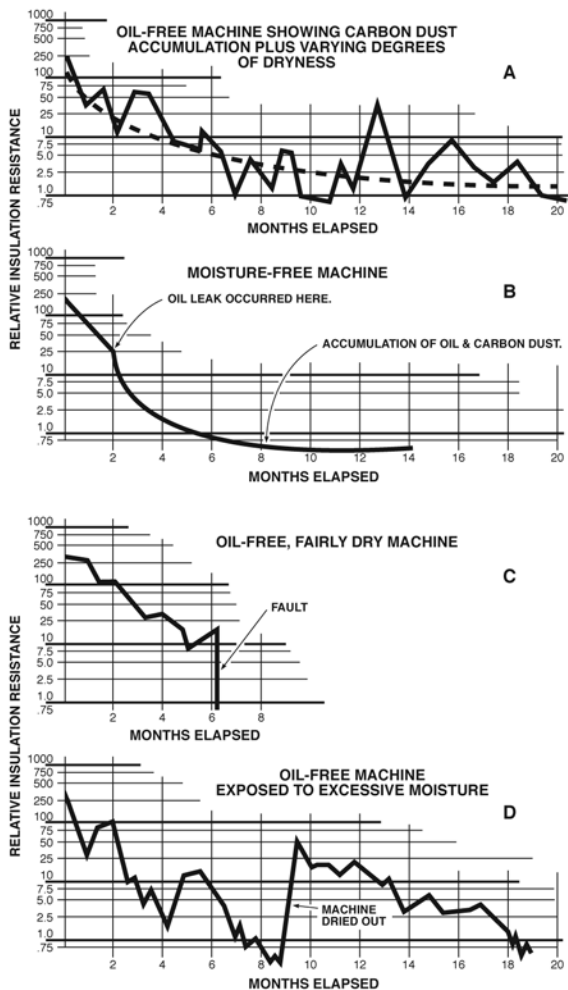

Figure 7—Typical behavior of insulation resistance over a period of months under varying operating conditions, (curves plotted from spot readings with a Megger instrument).

Time-Resistance Method

This method is fairly independent of temperature and often can give you conclusive information without records of past tests. It is based on the absorption effect of good insulation compared to that of moist or contaminated insulation. You simply take successive readings at specific times and note the differences in readings (see curves, Fig. 8). Tests by this method are sometimes referred to as absorption tests.

Note that good insulation shows a continual increase in resistance (less current – see curve A) over a period of time (in the order of 5 to 10 minutes). This is caused by the absorption current we spoke of earlier; good insulation shows this charge effect over a time period much longer than the time required to charge the capacitance of the insulation.

If the insulation contains much moisture or contaminants, the absorption effect is masked by a high leakage current which stays at a fairly constant value, keeping the resistance reading low (remember: $R = E/I$).

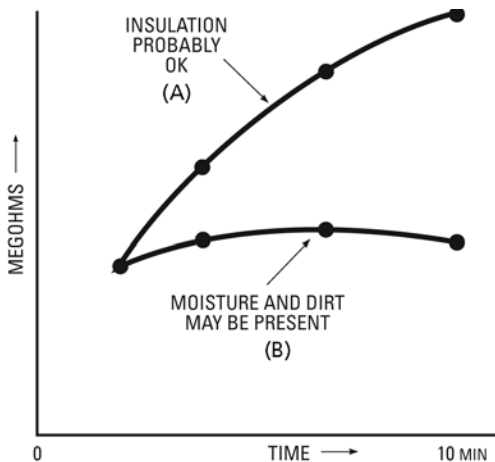

Figure 8—Typical curves showing dielectric absorption effect in a “time-resistance” test, made on capacitive equipment such as a large motor winding.

The time-resistance test is of value also because it is independent of equipment size. The increase in resistance for clean and dry insulation occurs in the same manner whether a motor is large or small. You can, therefore, compare several motors and establish standards for new ones, regardless of their horsepower ratings.

Fig. 9 shows how a 60-second test would appear for good and perhaps bad insulation. When the insulation is in good shape, the 60-second reading is higher than the 30-second reading.

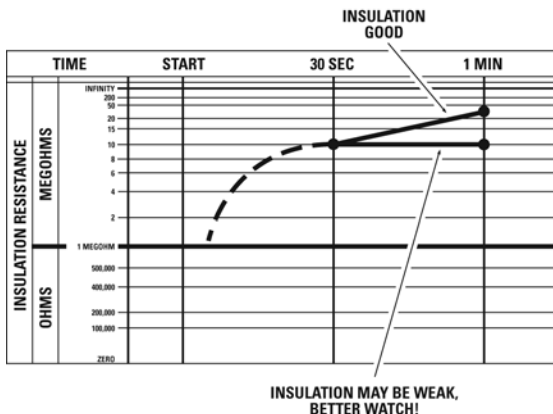

Figure 9—Typical card plot of a time-resistance or double-reading test.

A further advantage of this double-reading test, as it is sometimes called, is that it gives you a clearer picture, even when a spot reading says the insulation looks fine.

For example, let's say the spot reading on a synchronous motor was 10 megohms. Now, let's assume that the double-reading check shows that the insulation resistance holds steady at 10 megohms while you hold voltage up to 60 seconds. This means there may be dirt or moisture in the windings that bears watching. On the other hand, if the pointer shows a gradual increase between the 30-second and the 60-second checks, then you're reasonably sure the windings are in good shape.

Time-resistance tests on large rotating electrical machinery – especially with high operating voltage – require high insulation resistance ranges and a very constant test voltage. A heavy-duty Megger test set, line-operated, serves this need. Similarly, such an instrument is better adapted for large cables, bushings, transformers and switchgear.

Dielectric Absorption Ratio

The ratio of two time-resistance readings (such as a 60-second reading divided by a 30-second reading) is called a dielectric absorption ratio. It is useful in recording information about insulation. If the ratio is a 10-minute reading divided by a 1-minute reading, the value is called the polarization index.

With hand-cranked Megger instruments, it's a lot easier for you to run the test for only 60 seconds, taking your first reading at 30 seconds. If you have a line-operated Megger instrument, you'll get best results by running the test 10 minutes, taking readings at 1- and at 10-minutes, to get the polarization index. Table I gives values of the ratios and corresponding relative conditions of the insulation that they indicate.

TABLE I — Condition of Insulation Indicated by Dielectric Absorption Ratios*

INSULATION CONDITION	60/30-SECOND RATIO	10/1-MINUTE RATIO (POLARIZATION INDEX)
Dangerous	—	Less than 1
Questionable	1.0 to 1.25	1.0 to 2***
Good	1.4 to 1.6	2 to 4
Excellent	Above 1.6**	Above 4**

*These values must be considered tentative and relative—subject to experience with the time-resistance method over a period of time.

**In some cases, with motors, values approximately 20% higher than shown here indicate a dry brittle winding which will fail under shock conditions or during starts. For preventive maintenance, the motor winding should be cleaned, treated, and dried to restore winding flexibility.

***These results would be satisfactory for equipment with very low capacitance such as short runs of house wiring.

TEST VOLTAGE VS. EQUIPMENT RATING

Commonly used DC test voltages for routine maintenance are as follows:

Equipment AC Rating	DC Test Voltage
up to 100 volts	100 and 250 volts
440 to 550 volts	500 and 1,000 volts
2,400 volts	1,000 to 2,500 volts or higher
4,160 volts and above	1,000 to 5,000 volts, or higher

Test voltages used for proof testing of equipment are considerably higher than those used for routine maintenance. Although there are no published industry standards for DC maximum proof test voltages to be used with rotating equipment, the schedule given below is customarily used. For specific recommendations on your equipment, you should consult the manufacturer of the equipment.

Proof Test Voltages for Rotating Equipment:

Factory AC Test = 2 x Nameplate Rating + 1000 volts

DC Proof Test on Installation = 0.8 x Factory AC Test x 1.6

DC Proof Test After Service = 0.6 x Factory AC Test x 1.6

Example:

Motor with 2,400 VAC nameplate rating—

Factory AC Test = $2(2,400) + 1,000 = 5,800$ VAC

Max. DC Test on Installation = $0.8(5,800)1.6 = 7,424$ VDC

Max. DC Test After Service = $0.6(5,800)1.6 = 5,568$ VDC

AC TESTING VS. DC

Up to now, we've talked about testing with DC voltage, but you will hear of AC testing and need to know the difference. Remember that we spoke of the kinds of current produced in insulation by DC? (The initial surge of charging current, the drop with time to absorption current, and then, after more time, the steady conduction current.) We saw that in insulation testing, the conduction or leakage current is the one that gives us the information we need.

In contrast, testing with AC gives a charging current that is extremely large compared to the other kinds; leakage current is relatively minor. AC frequently is used for high-potential testing; voltage is increased to some specified point to see if the insulation can stand that particular voltage. It is a GO/NO-GO type of test and can cause deterioration of the insulation, in contrast to the DC test which is basically non-destructive.

If an AC test voltage has been used and you want to use DC tests as an alternative, you will need to increase the maximum DC test voltage somewhat to obtain equivalent results.

In some cases, AC testing may be more suitable for proof testing of equipment (that is, seeing that the equipment meets prescribed standards). You run the voltage up to the selected value and the equipment either passes or doesn't pass the test. With the DC test, you get a more qualitative picture; you can meter the leakage current as you increase the voltage and obtain specific values of insulation resistance.

As the size of your equipment increases, there are also marked economic advantages in DC over AC testing. As the test voltage increases, both the cost and weight of AC equipment go up much faster than with comparable DC test equipment. This is because the AC test set must supply the charging current which becomes and remains very high in the larger machines. As explained previously, in DC testing, this current drops rapidly after the initial charging period.

In summary, DC test sets are employed almost exclusively for high-voltage maintenance and field testing for the following reasons:

1. Lower cost
2. Lighter weight
3. Smaller size
4. Non-destructive
5. Better information, both in quality and quantity

USE OF DC DIELECTRIC TEST SET

The Megger instrument, reading directly in ohms and megohms of insulation resistance, is your best bet for routine in-plant maintenance. However, some plants, particularly with higher voltage ratings in equipment, use another Megger product – the dielectric test set. So, you should be aware of this instrument and its use in insulation resistance measurements.

The dielectric test set can be used to determine insulation resistance by the same test methods as outlined for the Megger instrument; that is, the short-time, time-resistance and step-voltage tests. It is designed for other uses, too, but for insulation testing it provides: (1) an adjustable output voltage and (2) a monitoring of the resultant current in micro-amperes. The Megger DC Dielectric Test Sets are available with voltage outputs ranging from 5 kV up to 160 kV.

The curves of Fig. 5 are plotted as current versus time, as are curves for insulation measurements on typical equipment given near the end of this manual. Megger supplies graph paper which makes it easy to plot megohms of insulation resistance from your voltage and current readings.

TESTS DURING DRYING OUT OF EQUIPMENT

Wet electrical equipment is a common hazard faced by all maintenance engineers. If the equipment is wet from fresh water, you go right ahead drying it out. However, if you've got salt water, you must first wash away the salt with fresh water. Otherwise, you'll leave very corrosive deposits of salt on metal and insulating surfaces as well as in crevices of the insulation. With moisture, such deposits form a very good conductor of electricity. Also, you should remove oil or grease from the insulation, using a suitable solvent.

There are various ways to dry out electrical equipment, depending upon its size and portability. You can use a blast of hot air, an oven, circulation of current through conductors, or a combination of techniques. Local plant conditions and facilities, together with information from the equipment manufacturers, can serve as a guide to the best method for your particular equipment.

In some cases, or with certain equipment, drying out may not be necessary. You can check this by insulation resistance tests, if you have records of previous tests on the apparatus. When drying out is required, such records are also helpful to determine when the insulation is free of moisture.

NOTE: Wet equipment is susceptible to voltage breakdown. Therefore, you should use a low-voltage Megger tester (100 or 250 VDC), at least in the early stages of a drying-out run. If a low-voltage instrument is not readily available, slow cranking of a 500-volt tester may be substituted.

Many testers have an additional test range measuring in kilohms ($k\Omega$). This measurement is typically made at only a few volts, and is the ideal initial measurement to be made on flooded equipment. This range measures below the Megohm range, and can, therefore, provide an actual measurement to use as a benchmark in monitoring the drying process. If a kilohm measurement is obtained, insulation has been thoroughly saturated, but may be reclaimable. Alternately test and dry, watching the readings rise until they reach the Megohm range, at which time higher voltage tests can be safely employed.

As an example of how important past readings are, let's look at a 100-hp motor that's been flooded. After a clean-up, a spot reading with the Megger tester shows 1.5 megohms. Offhand, you'd probably say this is ok. What's more, if past records showed the insulation resistance to run between 1 and 2 megohms, you'd be sure.

On the other hand, if past records showed the normal resistance values to run 10 or 20 megohms, then you would know that water was still in the motor windings.

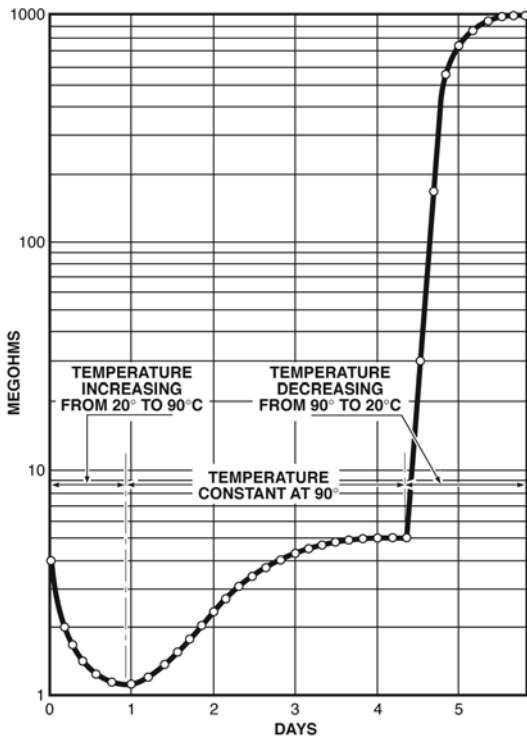

Figure 10-Typical drying curve where one-minute readings of insulation resistance are taken every four hours.

The typical drying-out curve for a DC motor armature (Fig. 10) shows how insulation resistance changes. During the first part of the run, the resistance actually decreases because of the higher temperature. Then it rises at a constant temperature as drying proceeds. Finally, it rises to a high value, as room temperature (20°C) is reached.

Note that if you conduct insulation resistance tests during drying, and you have readings of previous tests on the dry equipment, you'll know when you've reached the safe value for the unit. You may prefer to use a time-resistance test, taken periodically (say, once a shift), using the dielectric absorption ratio or polarization index to follow dry-out progress (no need to correct for temperature).

EFFECT OF TEMPERATURE ON INSULATION RESISTANCE

The resistance of insulating materials decreases markedly with an increase in temperature. As we've seen, however, tests by the time-resistance and step-voltage methods are relatively independent of temperature effects, giving relative values.

If you want to make reliable comparisons between readings, you should correct the readings to a base temperature, such as 20°C, or take all your readings at approximately the same temperature (usually not difficult to do). We will cover some general guides to temperature correction.

One thumb rule is:

***For every 10°C increase in temperature,
halve the resistance;
or, for every 10°C decrease,
double the resistance.***

For example, a two-megohm resistance at 20°C reduces to 1/2 megohm at 40°C.

Each type of insulating material will have a different degree of resistance change with temperature. Factors have been developed, however, to simplify the correction of resistance values. Table II gives such factors for rotating equipment, transformers and cable. You multiply the readings you get by the factor corresponding to the temperature (which you need to measure).

For example, assume you have a motor with Class A insulation and you get a reading of 2.0 megohms at a temperature (in the windings) of 104°F (40°C). From Table II you read across at 104°F to the next column (for Class A) and obtain the factor 4.80. Your corrected value of resistance is then:

2.0 megohms	x	4.80 =	9.6 megohms
(reading at 104°F)	(correction factor for Class A insulation at 104°F)	(corrected factor for Class A insulation at 104°F)	(reading for 68°F or 20°C)

Note that the resistance is almost five times greater at 68°F (20°C), as compared to the reading taken at 104°F. The reference temperature for cable is given as 60°F (15.6°C), but the important point is to be consistent and correct to the same base.

TABLE II-Temperature Correction Factors*

TEMP.		ROTATING EQUIP.		OIL-FILLED TRANSFORMERS	CABLES							
°C	°F	CLASS A	CLASS B		CODE NATURAL	CODE GR-5	PERFORMANCE NATURAL	HEAT RESIST. NATURAL	HEAT RESIST. & PERFORM. GR-5	OZONE RESIST. NATURAL GR-5	VARNISHED CAMBRIC	IMPREGNATED PAPER
0	32	0.21	0.40	0.25	0.25	0.12	0.47	0.42	0.22	0.14	0.10	0.28
5	41	0.31	0.50	0.36	0.40	0.23	0.60	0.56	0.37	0.26	0.20	0.43
10	50	0.45	0.63	0.50	0.61	0.46	0.76	0.73	0.58	0.49	0.43	0.64
15.6	60	0.71	0.81	0.74	1.00	1.00	1.00	1.00	1.00	1.00	1.00	1.00
20	68	1.00	1.00	1.00	1.47	1.83	1.24	1.28	1.53	1.75	1.94	1.43
25	77	1.48	1.25	1.40	2.27	3.67	1.58	1.68	2.48	3.29	4.08	2.17
30	86	2.20	1.58	1.98	3.52	7.32	2.00	2.24	4.03	6.20	8.62	3.20
35	95	3.24	2.00	2.80	5.45	14.60	2.55	2.93	6.53	11.65	18.20	4.77
40	104	4.80	2.50	3.95	8.45	29.20	3.26	3.85	10.70	25.00	38.50	7.15
45	113	7.10	3.15	5.60	13.10	54.00	4.15	5.08	17.10	41.40	81.00	10.70
50	122	10.45	3.98	7.85	20.00	116.00	5.29	6.72	27.85	78.00	170.00	16.00
55	131	15.50	5.00	11.20			6.72	8.83	45.00		345.00	24.00
60	140	22.80	6.30	15.85			8.58	11.62	73.00		775.00	36.00
65	149	34.00	7.90	22.40				15.40	118.00			
70	158	50.00	10.00	31.75				20.30	193.00			
75	167	74.00	12.60	44.70				26.60	313.00			

*Corrected to 20°C for rotating equipment and transformers; 15.6°C for cable.

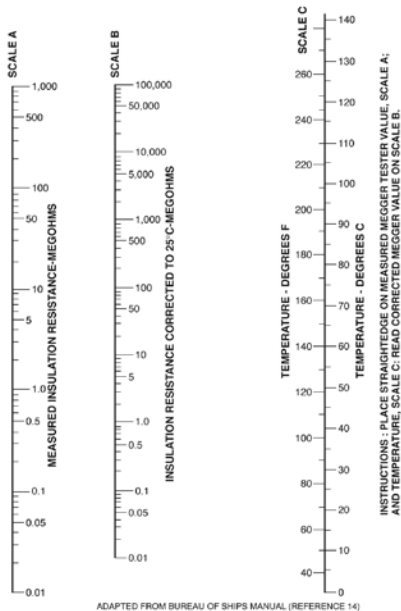

Nomograph of temperature correction values for Megger readings (corrected to 25°C). For rotating machinery with Class B insulation.

EFFECTS OF HUMIDITY

We have spoken at various points in this manual about the presence of moisture in insulation and its very marked effect upon resistance values. You might expect, therefore, that increasing humidity (moisture content) in the surrounding (ambient) air could affect insulation resistance. And it can to varying degrees.

If your equipment operates regularly above the dew-point temperature (the temperature at which the moisture vapor in air condenses as a liquid), the test reading normally will not be affected much by the humidity. Even if the equipment to be tested is idle, the same is true – so long as its temperature is kept above the dew point.

The aforementioned statement assumes that the insulation surfaces are free of contaminants, such as certain lint and acids or salts, which have the property of absorbing moisture (they're called "hygroscopic" or "deliquescent" materials by chemists). Their presence could unpredictably affect your readings; they should be removed before tests are made.

In electrical equipment we're concerned primarily with the conditions on the exposed surfaces where moisture condenses and affects the overall resistance of the insulation. Studies show, however, that dew will form in the cracks and crevices of insulation before it is visibly evident on the surface. Dew-point measurements will give you a clue as to whether such invisible conditions might exist, altering the test results.

As a part of your maintenance records, therefore, it's a good idea to make note at least of whether the surrounding air was dry or humid when the test was made. Also, whether the temperature was above or below the ambient. When you test vital equipment, record the ambient wet and dry bulb temperatures, from which dew-point and percent relative or absolute humidity can be obtained.

PREPARATION OF APPARATUS TO TEST

1. Take Out of Service

Shut down the apparatus. Open switches. De-energize. Disconnect from other equipment and circuits, including neutral and protective (workmen's temporary) ground connections. See **Safety Precautions**, page 26.

2. Make Sure Just What is Included in the Test

Inspect the installation very carefully to determine just what equipment is connected and will be included in the test, especially if it is difficult or expensive to disconnect associated apparatus and circuits. Pay particular attention to conductors that lead away from the installation. This is very important, because the more equipment that is included in a test, the lower the reading will be, and the true insulation resistance of the apparatus in question may be masked by that of the associated equipment.

It is always possible, of course, that the insulation resistance of the complete installation (without disconnecting everything) will be satisfactorily high, especially for a spot check. Or, it may be higher than the range of the

Megger instrument in use, in which case nothing would be gained by separating the components, because the insulation resistance of each part would be still higher.

For an initial test, it may be necessary to separate the component parts, even though labor and expense are involved, and test each one separately. Also make a test of all the components connected together. With this information on record, it may not be necessary to separate the components on future tests unless unaccountably low readings are observed.

3. Discharge of Capacitance

It is very important that capacitance be discharged, both before and after an insulation resistance test. It should be discharged for a period about four times as long as test voltage was applied in a previous test.

Megger instruments are frequently equipped with discharge circuits for this purpose. If a discharge function is not provided, a discharge stick should be used. Leave high capacitive apparatus (i.e., capacitors, large windings, etc.) short circuited until ready to re-energize.

4. Current Leakage at Switches

When apparatus is shut down for the insulation resistance test, make sure that the readings are not affected by leakage over or through switches or fuse blocks, etc. Such leakage may mask the true insulation resistance of the apparatus under test. See Use of a **Guard Terminal**, page 50.

Or, what may be more serious, current from an energized line may leak into the apparatus and cause inconsistent readings, particularly if the live line is DC. However, such leakage usually can be detected by watching the pointer of the Megger instrument at the moment the test leads are connected to the apparatus and before the instrument is operated. Before making these observations, be sure that all capacitance is discharged by short circuiting or grounding the apparatus.

CAUTION: Never connect a Megger insulation tester to energized lines or equipment. Never use the tester or any of its leads or accessories for any purpose not described in this book.

SAFETY PRECAUTIONS

Observe all rules for safety when taking equipment out of service. Block out disconnect switches. Test for foreign or induced voltages. Apply workmen's grounds.

Remember that when working around high voltage equipment there is always a possibility of voltages being induced in apparatus under test or lines to which it is connected, because of proximity to energized high voltage equipment. Therefore, rather than removing a workmen's ground in order to make a test, it is more advisable to disconnect the apparatus, such as a transformer or circuit breaker, from the exposed bus or line, leaving the latter grounded. Use rubber gloves when connecting the test leads to the apparatus and while operating the Megger instrument.

Apparatus Under Test Must Not Be Live!

See page 24 on **Preparation of Apparatus for Test**.

If neutral or other ground connections have to be disconnected, make sure they are not carrying current at the time, and that when disconnected no other equipment will lack necessary protection.

Pay particular attention to conductors that lead away from the circuit being tested and make sure they have been properly disconnected from any source of voltage.

Shock Hazard from Test Voltage

Observe the voltage rating of the Megger instrument and regard it with appropriate caution. Large electrical equipment and cables usually have sufficient capacitance to store up a dangerous amount of energy from the test current. Make sure this capacitance is discharged after the test and before handling the test leads. See also **Discharge of Capacitance**, page 25.

Explosion and Fire Hazard

So far as is known, there is no fire hazard in the normal use of a Megger insulation tester. There is, however, a hazard when testing equipment located in inflammable or explosive atmospheres.

Slight sparking may be encountered:

- (1) When attaching the test leads to equipment in which the capacitance has not been completely discharged
- (2) During a test, arcing through or over faulty insulation
- (3) Following a test when capacitance is discharged

CAUTION:

**Do not use the instrument
in an explosive atmosphere.**

Suggestions:

For (1) and (3): Arrange permanently installed grounding facilities and test leads to a point where instrument connections can be made in a safe atmosphere.

For (2): Use low-voltage testing instruments, or a series resistance.

For (3): Do not disconnect the test leads for at least 30 to 60 seconds following a test, allowing time for capacitance discharge.

**CONNECTIONS FOR TESTING INSULATION RESISTANCE
OF ELECTRICAL EQUIPMENT**

The following diagrams show how to connect a Megger insulation tester to various types of electrical equipment. The diagrams also show in principle how equipment must be disconnected from other circuits before the instrument is connected.

These illustrations are typical and will serve as guides for testing insulation resistance of practically all types of apparatus and conductors.

Before proceeding with tests, read the article on **Preparation of Apparatus for Test**, page 24.

REMEMBER! The Megger insulation resistance tester measures whatever resistance is connected between its terminals. This may include series or parallel leakage paths through insulation or over its surface.

1. AC Motors & Starting Equipment

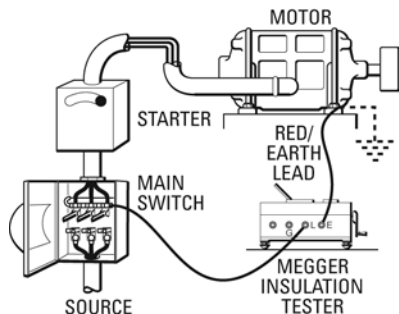

Figure 11

Connections for testing the insulation resistance of a motor, starting equipment and connecting lines, in parallel. Note that the starter switch is in the "on" position for the test. It is always preferable to disconnect the component parts and test them separately in order to determine where weaknesses exist.

2. DC Generators & Motors

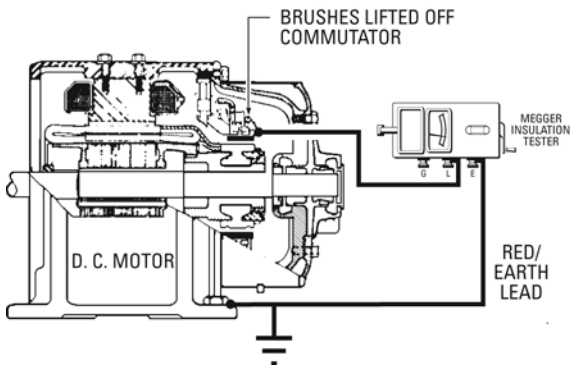

Figure 12

With the brushes raised as indicated, the brush rigging and field coils can be tested separately from the armature. Likewise the armature can be tested by itself. With the brushes lowered, the test will be that of brush rigging, field coils and armature combined.

3. Wiring Installation

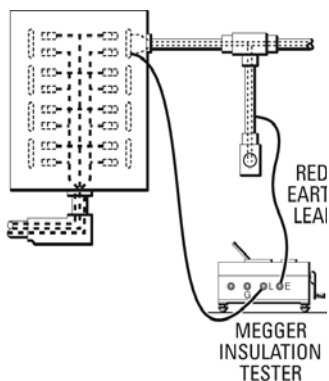

Figure 13

Connections for testing to ground each circuit separately, working from the distribution panel.

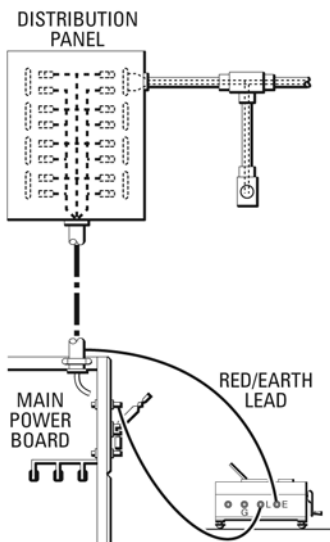

Figure 14

Connections at the main power board, from which point the entire system can be tested to ground at one time, providing all switches in the distribution panel are closed.

4. Appliances, Meters, Instruments & Miscellaneous Electrical Apparatus

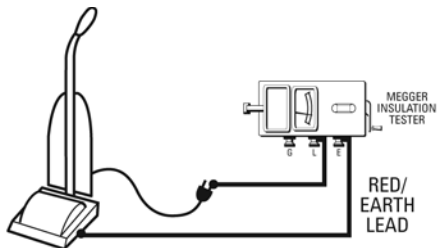

Figure 15

Connections for testing an appliance. The test is made between the conductor (the heating unit, motor, etc.) and exposed metal parts. The apparatus must be disconnected from any source of power and placed on some insulating material.

5. Control, Signaling & Communication Cables

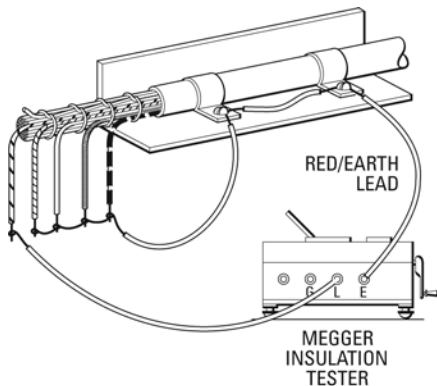

Figure 16

Connections for testing insulation resistance of one wire in a multi-conductor cable against all other wires and sheath connected together.

16. Power Cables

Connections for testing the insulation resistance of a power cable. When testing cable, it is usually best to disconnect at both ends in order to test the cable by itself, and to avoid error due to leakage across or through switchboards or panelboards. See also **Use of Guard Terminal**, page 50.

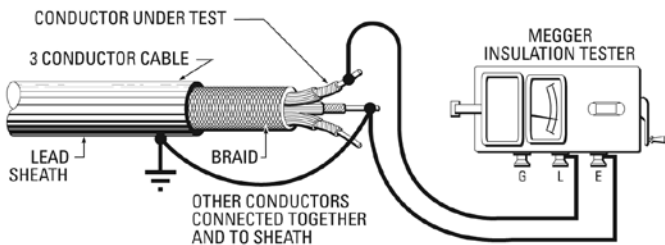

Figure 17

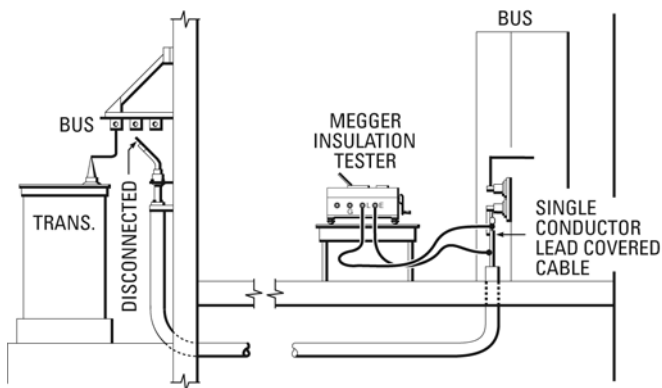

Figure 18

7. Power Transformers

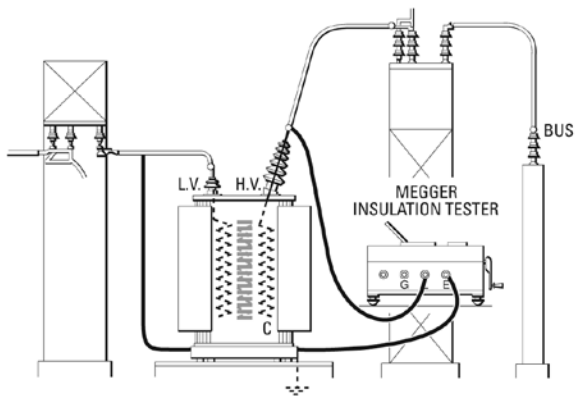

Figure 19

Connections for testing insulation resistance of a transformer high voltage winding and bushings, and the high tension disconnect switch, in parallel, with reference to the low voltage winding and ground. Note that the low voltage winding is grounded for this test.

8. AC Generators

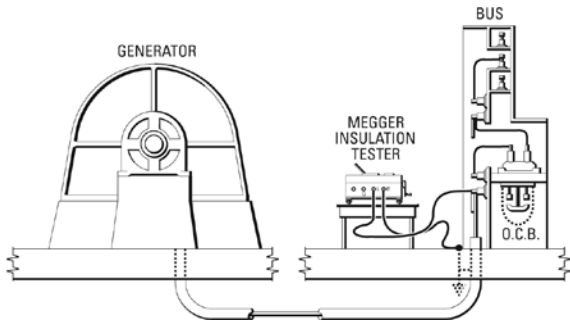

Figure 20

With this connection, the insulation resistance will be that of the generator stator winding and connecting cable combined. To test either the stator winding or the cable itself, the cable must be disconnected at the machine.

ADDITIONAL NOTES ABOUT USING A MEGGER INSULATION TESTER

Testing Leads

Inferior or defective testing leads will cause erroneous and misleading results of insulation resistance tests. Take care in this respect.

Uninsulated Leads

To avoid error due to the insulation of leads, place the Megger instrument close to the ungrounded terminal or conductor of the apparatus under test and connect a short piece of light bare wire directly from the Line terminal of the instrument to the apparatus. If the Guard terminal is used, it may be treated similarly. No. 18 or 20 gauge, solid wire will suffice. Support the lead only by its connections to the instrument and the apparatus.

With this method of connecting from the Line terminal, the quality of the insulation, if any, of the Earth or Ground lead becomes unimportant.

Insulated Leads

Where dependence is placed on the insulation of leads, they must be durable and of the best quality insulating material. Oil resistant, synthetic, rubber-insulated, single-conductor No. 14 stranded wire is recommended. The outer jacket should be smooth, with no outer braid. Lugs should be fitted for attaching to the instrument terminals, and stout spring clips are recommended for connecting to the apparatus or circuit under test. Any convenient length of lead may be used. Joints are to be avoided.

After connecting the leads to the instrument, and just before connecting them to the apparatus, make sure there is no leak from lead to lead. Do this by operating the instrument, which should read Infinity. Do not correct slight lead leakage by attempting to reset the Infinity Adjuster on a high-range instrument. Then touch the test ends of the leads together to make sure they are not disconnected or broken.

Current testing with the high-range (50,000 megohms) Megger insulation testers requires that the Line test lead be maintained at a high value so that it will not enter into the measurement. The shielded test lead, with the shield connected to Guard, prevents any leakages over its terminations or through the lead insulating material, from being measured.

Instructions for Use

The untagged end of the shielded lead is to be connected to the Line and Guard terminals of the Megger instrument – the end terminal to Line and the side (shield) terminal to Guard. The clip on the Line lead is connected to the apparatus under test in the regular way. The outboard Guard terminal may be connected to that part of the apparatus under test which the user wishes to guard. The conductor employed in making this connection must be insulated for the voltage rating of the Megger instrument used.

Effect of Capacitance

Capacitance in apparatus under test must be charged up to the rated DC voltage of the Megger insulation tester, and maintained for 30 to 60 seconds before a final reading is taken. Make sure that capacitance is discharged, by short circuiting and grounding the apparatus before connecting the test leads. See **Discharge of Capacitance**, page 25.

NOTE: Capacitance causes the pointer to swing towards zero while the instrument is being brought up to speed, and to swing off scale beyond infinity when the generator is slowing down. This is simply the charge flowing into and out of the capacitance and through the deflecting coil of the ohmmeter.

Capacitance effects are most noticeable in large generators, in power and communication cable more than a few hundred feet in length, and in capacitors. In general, these effects are small with capacitance of less than 0.01 F. It becomes more noticeable as capacitance and/or the sensitivity of the instrument increases. The heavy-duty series of Megger insulation testers can be used on large capacitors with good results, particularly when operated from the power line rather than the hand crank.

Operating Time

A very important consideration in making insulation resistance tests is the time required for the reading of insulation resistance to reach a maximum. The time required to charge the geometric capacitance is very short – usually no more than a few seconds – and that which causes further delay in reaching full charge is a dielectric absorption effect. It may be a matter of minutes or even hours for this electrification time to be completed, and for the pointer to reach an absolute maximum.

Short-Time Readings

For short-time readings of insulation resistance, operate the instrument for a definite length of time, either 30 seconds or 1 minute, and read at the end of that time. Continue cranking steadily at slip speed until the reading has been taken. Make future tests with the same length of operating time.

Time-Resistance Method

When using a hand-cranked instrument, operate continuously for 1 minute. Take a reading at the end of the first 30 seconds and another reading at the end of the minute.

When using a motor-driven or rectifier-operated instrument, the time intervals are usually 1 minute and 10 minutes from the time the testing voltage is applied. Or, time-resistance curves may be taken over a period of 10 to 30 minutes or longer.

Voltage Scales

Some insulation testers may be supplied with a voltage scale to check for the absence of voltage before insulation testing. As explained in the **Safety Precautions** section, however, insulation testers should never be connected to energized lines or equipment when operated in any of the Insulation Test or Resistance Test modes.

INTERPRETATION-MINIMUM VALUES

Insulation resistance of electrical equipment is affected by many variables such as the equipment design; the type of insulating material used, including binders and impregnating compounds; the thickness of the insulation and its area; cleanliness, moisture and temperature. For insulation resistance readings to be a conclusive measure of the condition of the equipment being tested, these variables must be taken into consideration.

After the equipment has been put into service, factors such as the design of the equipment, the kind of insulating material used, and its thickness and area cease to be variables, allowing minimum insulation resistance values to be established within reasonable tolerances. The variables that must be considered after the equipment had been put into service, and at the time that the insulation resistance measurements are being made, are cleanliness, moisture, temperature and mechanical damage (such as fractures).

Good Housekeeping

The most important requirements in the reliable operation of electrical equipment are cleanliness, and the elimination of moisture penetration into the insulation. This may be considered as good housekeeping, and is essential in the maintenance of all types of electrical equipment. The very fact that insulation resistance is affected by moisture and dirt, with due allowances for temperature, makes the Megger insulation tester the valuable tool that it is in electrical maintenance. It is at once a gauge of cleanliness and good housekeeping as well as a detector of deterioration and impending trouble.

What Readings to Expect– Periodic Tests

Several criteria for minimum values of insulation resistance have been developed and are summarized here. They should serve as a guide for equipment in service. However, periodic tests on equipment in service will usually reveal readings considerably higher than the suggested minimum safe values.

Therefore, it is strongly recommended that records of periodic tests be kept, because persistent downward trends in insulation resistance usually give fair warning of impending trouble, even though the actual values may be higher than the suggested minimum safe values.

Conversely, allowances must be made for equipment in service showing periodic test values lower than the suggested minimum safe values, so long as the values remain stable or consistent. In such cases, after due consideration has been given to temperature and humidity conditions at the time of test, there may be no need for concern. This condition may be caused by uniformly distributed leakages of a harmless nature, and may not be the result of a dangerous localized weakness.

Here again, records of insulation resistance tests over a period of time reveal changes which may justify investigation. The trend of the curve may be more significant than the numerical values themselves.

The One-Megohm Rule

For many years one megohm has been widely used as a fair allowable lower limit for insulation resistance of ordinary industrial electrical equipment rated up to 1000 volts, and is still recommended for those who may not be too familiar with insulation resistance testing practices, or who may not wish to approach the problem from a more technical point of view.

For equipment rated above 1000 volts the one megohm rule is usually stated as a minimum of one megohm per thousand volts. Although this rule is somewhat arbitrary, and may be criticized as lacking an engineering foundation, it has stood the test of a good many years of practical experience. It gives some assurance that equipment is not too wet or dirty and has saved many an unnecessary breakdown.

More recent studies of the problem, however, have resulted in formulas for minimum values of insulation resistance that are based on the kind of insulating material used and the electrical and physical dimensions of the types of equipment under consideration.

MINIMUM VALUES FOR INSULATION RESISTANCE

Rotating Machinery

The IEEE guide, "Recommended Practices for Testing Insulation Resistance of Rotating Machinery", deals with the problem of making and interpreting insulation resistance measurements for rotating machinery. It reviews the factors which affect or change insulation resistance characteristics, outlines and recommends uniform methods for making tests, and presents formulas for the calculation of approximate minimum insulation resistance values for various types of AC and DC rotating machinery. The guide states:

"The recommended minimum insulation resistance R_m for alternating-current and direct-current machine armature windings and for field windings of alternating-current and direct-current machines can be determined by:

$$R_m = kV + 1$$

where:

R_m = recommended minimum insulation resistance in megohms at 40°C of the entire machine winding

kV = rated machine terminal to terminal potential, in kilovolts

In applications where the machine is vital, it has been considered good practice to initiate reconditioning should the insulation resistance, having been well above the minimum value given by Eq 2, drop appreciably to near that level."

It is recommended that those who operate and maintain rotating machinery obtain copies of the IEEE publication, "Recommended Practices for Testing Insulation Resistance of Rotating Machinery", which can be obtained by writing the IEEE at 345 East 47th St., New York, NY, 10017.

Bushings

In the case of outdoor oil circuit breaker bushings, experience has shown that any bushing, with its assembled associated insulating members, should, for reliable operation, have an insulation resistance value above 10,000 megohms at 20°C. This assumes that the oil within the tank is in good condition, that the breaker is separated from its external connections to other equipment, and that the porcelain weather shield is guarded. This means that each component such as the stripped bushing itself, cross-member, lift rod, lower arcing shield, etc., should have an insulation resistance in excess of that value.

Any components which are superficially clean and dry and have values less than 10,000 megohms are usually deteriorated internally, by the presence of moisture or carbonized paths, to such an extent that they are not reliable for good service unless reconditioned. This is particularly so when operating under surge conditions such as during lightning disturbances. In the case of the stripped bushing itself, the lower stem and upper weather shield must be either perfectly clean or guarded before it is condemned as unreliable because of an insulation resistance value less than 10,000 megohms.

What has been said for stripped oil circuit breaker bushings also applies to bushings for other equipment, such as transformers. Since bushings and other associated members have very high insulation resistance values normally, a Megger insulation tester having a range of at least 10,000 megohms is necessary to test such equipment. Megger instruments having ranges up to 50,000 megohms will permit observation of deteriorating trends in bushings before they reach the questionable value of 10,000 megohms.

Cable and Conductors

Cable and conductor installations present a wide variation of conditions from the point of view of the resistance of the insulation. These conditions result from the many kinds of insulating materials used, the voltage rating or insulation thickness, and the length of the circuit involved in the measurement. Furthermore, such circuits usually extend over great distances, and may be subjected to wide variations in temperature, which will have an effect on the insulation resistance values obtained. The terminals of cables and conductors will also have an effect on the test values unless they are clean and dry, or guarded.

The Insulated Cable Engineers Association (ICEA) gives minimum values of insulation resistance in its specifications for various types of cables and conductors. These minimum values are for new, single-conductor wire and cable after being subjected to an AC high voltage test and based on a DC test potential of 500 volts applied for one minute at a temperature of 60°F.

These standard minimum values (for single-conductor cable) are based on the following formula:

$$R = K \log_{10} D/d$$

where:

- R = megohms per 1000 feet of cable
- K = constant for insulating material
- D = outside diameter of conductor insulation
- d = diameter of conductor

Minimum Values of K at 60° F.

Insulation Type

Impregnated Paper	2,640
Varnished Cambric	2,460
Thermoplastic-Polyethylene	above 50,000
Composite Polyethylene	30,000
Thermoplastic-Polyvinyl:	
Polyvinyl Chloride 60°C.....	500
Polyvinyl Chloride 75°C.....	2,000

Grade	Natural Rubber	Synthetic Rubber
Code		950
Performance	10,560.....	2,000
Heat Resistant.....	10,560.....	2,000
Ozone Resistant.....	10,000 (Butyl).....	2,000
Kerite		4,000

See pages 44 and 45 for Tables of $\log_{10} D/d$

The insulation resistance of one conductor of a multiconductor cable to all others and sheath is:

$$R = K \log_{10} \frac{D}{d}$$

where:

D = diameter over insulation of equivalent single-conductor cable
= $d + 2c + 2b$

d = diameter of conductor (for sector cables d equals diameter of round conductor of same cross-section)

c = thickness of conductor insulation

b = thickness of jacket insulation

(all dimensions must be expressed in same units)

Transformers

Acceptable insulation resistance values for dry and compound-filled transformers should be comparable to those for Class A rotating machinery, although no standard minimum values are available.

Oil-filled transformers or voltage regulators present a special problem in that the condition of the oil has a marked influence on the insulation resistance of the windings.

In the absence of more reliable data the following formula is suggested:

$$R = \frac{CE}{\sqrt{kVA}}$$

R = minimum 1-minute 500-volt DC insulation resistance in megohms from winding to ground, with other winding or windings guarded, or from winding to winding with core guarded

C = a constant for 20°C measurements

E = voltage rating of winding under test

kVA = rated capacity of winding under test

For tests of winding to ground with the other winding or windings grounded, the values will be much less than that given by the formula. R in this formula is based on dry, acid-free, sludge-free oil, and bushings and terminal boards that are in good condition.

Values of C at 20°C

	<u>60-Hertz</u>	<u>25-Hertz</u>
Tanked oil-filled type	1.5	1.0
Untanked oil-filled type	30.0	20.0
Dry or compound-filled type	30.0	20.0

This formula is intended for single-phase transformers. If the transformer under test is of the three-phase type, and the three individual windings are being tested as one, then:

E = voltage rating of one of the single-phase windings
(phase to phase for delta connected units and phase to neutral for star connected units)

kVA = rated capacity of the completed three-phase winding under test

TESTS USING MULTI-VOLTAGE MEGGER INSULATION TESTERS

Maintenance practice trends indicate the value of testing insulation with DC voltages at levels somewhat higher than the peak value of the rated AC voltage of the equipment being tested. Such DC tests have in some cases been shown to reveal non-destructively incipient weaknesses in insulation which could not otherwise be found, except possibly by partial discharge detection at non-destructive AC test voltage levels.

The technique involves the application of two or more DC voltages, and critically observing any reduction of insulation resistance at the higher voltage. Any marked or unusual reduction in insulation resistance for a prescribed increase in applied voltage is an indication of incipient weakness.

It is important to mention that the merits of this technique arise from more recent investigations which indicate that rather high DC voltage can be used to detect weaknesses without damaging the insulation. The maximum value of voltage which should be used will depend largely on the cleanliness and dryness of the insulation to be tested.

In making tests on insulation at such DC voltages, the ohmmeter method has at least two advantages. First, prescribed fixed voltages are switched into use, and one instrument measurement made with the direct reading ohmmeter. This is a simple and reproducible method compared to one in which many choices of voltage are available. Another important advantage

of the ohmmeter can be explained by referring to Fig. 21. In this figure, the change which may occur in leakage current after the absorption current has disappeared is shown plotted in terms of insulation resistance against three different voltages. Note that there is no change in resistance shown in the figure between 500 and 1000 volts, indicating no change in the insulation as a result of applying these two voltages. This is an assumption, but is a condition which is not uncommon in practice. If the insulation continues to be stable at 2500 volts, there will be no change in the insulation resistance value obtained, which is shown by the dotted extension of the horizontal line in the figure. When non-linear conditions appear at a higher voltage, the voltage resistance curve reveals this very clearly by a lower resistance value, indicated by the downward curve in the figure. The figure, therefore, reveals the simplicity of determining the change in insulation stability by using three fixed voltages which are easily reproducible when making three-voltage tests on a routine basis.

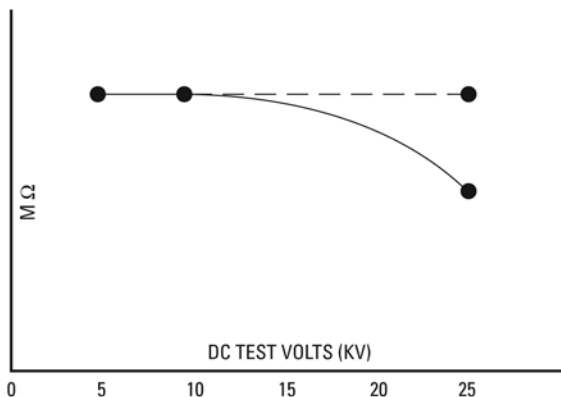

Figure 21

We wish to emphasize that the curve in Fig. 21 indicates the resistance change due to leakage current only, and not the absorption current which may appear for a period of time with each change in voltage. It may be necessary to wait an appreciable amount of time after each voltage change for the absorption current to disappear before taking a reading.

VALUES OF $\text{LOG}_{10} \frac{D}{d}$

A. W.G. or C.M.		INSULATION THICKNESS - INCHES												
		.047	.063	.078	.094	.109	.125	.141	.156	.172	.188	.203	.219	.234
14	Sol.	.392	.470	.537	.594	.645	.691	.732	.770	.804	.836	.866	.894	.921
12		.334	.405	.467	.520	.568	.611	.651	.686	.720	.751	.779	.806	.832
10		.283	.348	.404	.453	.498	.538	.575	.609	.641	.670	.698	.723	.748
8		.239	.296	.347	.392	.432	.470	.505	.537	.566	.594	.621	.645	.669
6	Str.	.225	.275	.326	.373	.414	.453	.493	.531	.566	.601	.636	.669	.701
5		.206	.245	.285	.324	.363	.401	.440	.476	.511	.546	.581	.615	.649
4		.187	.224	.261	.298	.335	.371	.408	.443	.478	.513	.548	.582	.616
3		.171	.204	.236	.265	.293	.318	.343	.366	.388	.409	.429	.448	.467
2		.155	.186	.215	.243	.269	.293	.316	.338	.359	.379	.398	.416	.434
1		.139	.168	.195	.220	.244	.267	.288	.309	.328	.347	.365	.382	.400
1/0		.126	.152	.177	.201	.223	.244	.264	.284	.302	.320	.337	.354	.371
2/0		.114	.138	.161	.183	.204	.223	.242	.261	.278	.295	.311	.327	.343
3/0		.102	.125	.146	.166	.185	.204	.221	.238	.255	.271	.286	.301	.316
4/0		.0923	.113	.132	.151	.168	.187	.202	.218	.233	.248	.262	.276	.290
250,000		.0854	.104	.123	.140	.157	.173	.189	.204	.218	.232	.246	.259	.272
300,000		.0787	.0963	.113	.130	.145	.160	.175	.189	.203	.216	.229	.241	.253
350,000		.0731	.0897	.106	.121	.136	.150	.164	.177	.190	.203	.215	.227	.238
400,000		.0688	.0845	.0995	.114	.128	.142	.155	.168	.181	.193	.204	.216	.227
500,000		.0620	.0763	.0901	.103	.116	.129	.141	.153	.165	.176	.187	.198	.209
600,000			.0700	.0853	.0952	.107	.119	.130	.141	.152	.163	.173	.183	.193
700,000			.0686	.0769	.0888	.100	.111	.122	.133	.143	.153	.163	.172	.181
750,000			.0665	.0749	.0861	.0971	.108	.118	.129	.139	.148	.157	.167	.176
800,000			.0644	.0727	.0836	.0943	.105	.115	.125	.135	.144	.154	.163	.172
900,000			.0580	.0687	.0793	.0895	.0994	.108	.120	.128	.137	.146	.155	.164
1,000,000			.0551	.0656	.0755	.0851	.0948	.104	.113	.122	.131	.140	.148	.157
1,250,000			.0500	.0590	.0681	.0770	.0856	.0943	.103	.111	.119	.127	.134	.142
1,500,000			.0456	.0541	.0625	.0708	.0789	.0870	.0946	.102	.110	.116	.125	.132
1,750,000			.0423	.0502	.0581	.0658	.0734	.0810	.0899	.0954	.103	.110	.117	.124
2,000,000			.0397	.0472	.0546	.0619	.0691	.0761	.0830	.0898	.0965	.103	.108	.114
2,500,000			.0357	.0425	.0492	.0558	.0623	.0687	.0750	.0812	.0874	.0934	.0993	.105

Values continued on next page.

VALUES OF $\text{LOG}_{10} \frac{D}{d}$

A. W.G. or C.M.	INSULATION THICKNESS - INCHES												
	.250	.266	.281	.297	.313	.328	.344	.359	.375	.391	.407	.422	.438
14 Sol.	.945												
12	.856												
10	.771												
8	.691	.712	.731	.834	.853	.871	.889	.906	.922				
6 Str.	.570	.590	.608	.626	.643	.660	.676	.699	.706	.851	.866	.880	.894
5	.535	.554	.572	.589	.606	.622	.637	.652	.667	.680	.694	.707	.720
4	.500	.517	.535	.551	.568	.583	.598	.613	.625	.640	.653	.666	.678
3	.466	.483	.500	.516	.532	.547	.562	.576	.589	.603	.615	.628	.640
2	.433	.450	.466	.482	.497	.512	.526	.540	.553	.565	.578	.590	.602
1	.399	.415	.431	.445	.461	.474	.487	.501	.513	.525	.538	.549	.561
1/0	.369	.385	.399	.414	.428	.441	.454	.466	.479	.491	.502	.514	.525
2/0	.342	.356	.370	.384	.397	.410	.422	.435	.446	.458	.469	.480	.490
3/0	.315	.329	.342	.355	.367	.380	.392	.403	.414	.425	.436	.447	.457
4/0	.289	.302	.315	.327	.339	.351	.362	.373	.384	.395	.405	.415	.425
250,000	.272	.284	.296	.309	.320	.331	.342	.352	.363	.373	.383	.392	.402
300,000	.254	.266	.278	.289	.300	.310	.321	.331	.341	.351	.360	.369	.379
350,000	.239	.250	.262	.272	.283	.293	.303	.313	.323	.332	.341	.350	.359
400,000	.227	.236	.249	.259	.269	.279	.289	.298	.308	.317	.326	.334	.343
500,000	.208	.218	.228	.238	.248	.257	.266	.275	.284	.292	.301	.309	.317
600,000	.193	.203	.212	.221	.230	.239	.248	.256	.265	.273	.281	.289	.297
700,000	.181	.191	.199	.209	.217	.225	.234	.242	.250	.258	.266	.273	.281
750,000	.176	.185	.194	.203	.211	.220	.228	.236	.243	.251	.259	.266	.273
800,000	.172	.180	.189	.198	.206	.214	.222	.230	.237	.245	.252	.260	.267
900,000	.164	.172	.180	.189	.196	.204	.212	.219	.227	.234	.242	.249	.255
1,000,000	.157	.165	.173	.181	.189	.196	.203	.211	.218	.225	.232	.239	.245
1,250,000	.142	.150	.157	.165	.172	.179	.186	.192	.199	.206	.212	.219	.225
1,500,000	.132	.139	.146	.153	.159	.166	.172	.179	.185	.190	.197	.204	.210
1,750,000	.123	.130	.136	.143	.149	.155	.162	.168	.174	.180	.185	.191	.197
2,000,000	.116	.122	.128	.135	.141	.145	.153	.159	.164	.170	.176	.181	.187
2,500,000	.105	.111	.117	.122	.128	.134	.139	.144	.150	.156	.160	.165	.170

To better understand the technique of making insulation resistance tests at two or more voltages, the following steps are suggested, using an industrial or traction motor classed in the 300- to 1000-volt range as an example:

1. Make a one-minute Megger instrument test at 500 volts to serve as a basis of comparison for subsequent steps.
2. After a careful cleaning operation make a second 500-volt test to determine the effectiveness of the cleaning.
3. If the one-minute insulation resistance value is subnormal, or if the 60 second/30 second insulation resistance ratio is no greater than one at this point then a drying operation may be desirable before using a higher test voltage. However, making another test at 1000 volts and comparing these readings with those from the 500-volt test will help in determining the need for drying. If the 1000-volt test value is appreciably less than that at 500 volts, then a drying operation should be performed. On the other hand, if the 1000-volt and 500-volt test values are approximately the same, it is reasonable to assume that the decision to perform a drying operation can be deferred until after the next step.
4. Make a Megger instrument test at 2500 volts. If there is no appreciable difference in the 500- and 2500-volt test values, good evidence exists that the motor in question is in reliable condition as far as its insulation is concerned. On the other hand, if there is an appreciable difference in the two, there is good evidence that more thorough reconditioning is called for. If the insulation fails under the 2500-volt test, after following steps 1, 2 and 3, we believe there is a likelihood that the motor in question would fail in service even though an attempt were made to recondition it on the basis of low-voltage tests only.

The multi-voltage method can also be helpful in determining the presence of excessive moisture in the insulation of equipment rated at voltages equivalent to or greater than the highest voltage available from the multi-voltage Megger instrument being used. In other words, even though the highest Megger instrument voltage available does not stress the insulation beyond its rating, a two-voltage test can, nevertheless, often reveal the

presence of moisture. If the insulation resistance is first tested on the short-time reading basis (first at one voltage level and then at a higher potential), a lower value of insulation resistance at the higher DC test voltage usually indicates the presence of moisture. The applied voltages should preferably be in the ratio of 1 to 5. Experience has indicated that a change of 25% in the insulation resistance value, with a 1 to 5 ratio in test voltages, is usually due to the presence of an excessive amount of moisture.

This method is not based on a dielectric absorption phenomena, but it does relate to the Evershed Effect. As with time-resistance measurements, the multi-voltage method of testing insulation resistance has increased value when made on a periodic or scheduled basis.

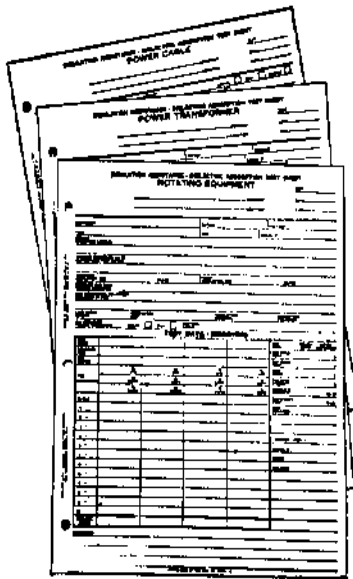

Figure 22-Time Resistance Test Forms

STEP-VOLTAGE METHOD

In this method, you need a multi-voltage Megger instrument to apply two or more voltages in steps, like 500 volts and then 1000 volts. You look for any reduction of insulation resistance at the higher voltage. If the resistance is lower, it's a sign of an insulation weakness that shows up only at the higher voltage. Fig. 23 shows an example in which, instead of progressively increasing the voltage, you first test at a low voltage (such as 500 volts) and then, after discharging the sample, you test again at a higher voltage (such as 2500 volts). Any difference in the two tests in terms of megohms will show signs of weakness at the higher voltage – a warning to investigate further. As the conditions within the sample deteriorate, the higher-voltage plot, as shown in Fig. 23, will reduce in megohms compared to the lower-voltage plot, and its upward slope will be less.

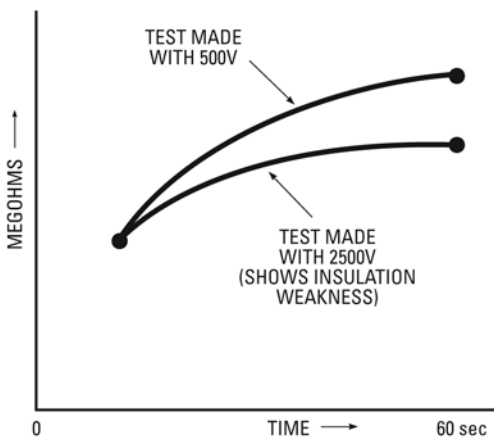

Figure 23—Typical curves with the “step-voltage” test.

The theory behind the step-voltage technique is a bit complex, but we'll try to keep it simple. Moisture and dirt in insulation are usually revealed by tests at voltages far below those expected in service. However, effects of aging or mechanical damage in fairly clean and dry insulation may not be revealed at such low stress.

Now, when the voltage is increased in steps to produce electrical stresses which approach or exceed those encountered in service, then local weak spots influence the overall insulation resistance more and more. The resistance of such local faults generally decreases rapidly as the electrical stress in them increases beyond a certain limit. The plot of consecutive Megger instrument readings clearly shows the sharp drop when this occurs (see Fig. 24).

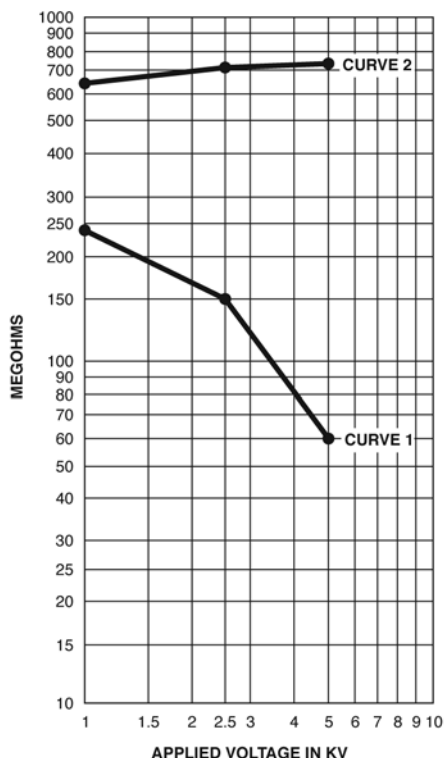

Figure 24-Test curves by the step-voltage method, comparing results with good and bad insulation. Curve 1 (lower plot) shows definite drop in resistance with increasing voltage, indicating a problem. Curve 2 (upper plot) shows conditions found in the same motor winding after cleaning, baking and impregnating operation.

You only need to keep the test voltage constant between steps for about 60 seconds. This short period will not affect the trend in resistance change. The timed period, however, should always be the same for a given piece of equipment. All the absorption current may not have disappeared in this time, but your resistance measurements will be made on the same basis and therefore will be meaningful. Your results are independent of the insulation material and its temperature because you're looking at the change in resistance – not the absolute resistance values.

As is true with the spot-reading and time-resistance measurements, the step-voltage method is more valuable to you when repeated on a periodic, scheduled basis.

The step-voltage method is particularly useful in determining the presence of excessive moisture or other contaminants in the insulation of equipment that is rated at voltages equivalent to or greater than the highest voltage available in your multi-voltage Megger instrument. In other words, even though your highest voltage does not stress the insulation beyond its rating, a two-voltage test can, nevertheless, often reveal the presence of such contaminants.

For example, assume that you first test insulation resistance on a short-time reading basis – at a voltage of 500 VDC, and then at a higher potential of, say, 2500 VDC. Even though the latter voltage may be nominal in relation to the voltage rating of your equipment, a lower value of insulation resistance at the higher test voltage usually indicates the presence of contaminated fractures or other leakage paths through the insulation to ground.

The applied voltages should preferably be in the ratio of 1 to 5 or greater (500 and 2500, for example). Results to date show that a change of 25% in the insulation resistance value, with a 1 to 5 ratio in test voltages, is usually due to the presence of an excessive amount of moisture or other contaminant.

USE OF A GUARD TERMINAL

All Megger insulation testers having ranges of 1000 megohms and higher are equipped with Guard terminals. The purpose of this terminal is to provide facilities for making a three-terminal network measurement, so that the resistance of one of two possible paths can be determined directly. It has the further or secondary purpose of providing a source of DC voltage of good regulation and of limited current capacity.

The insulation of all electrical apparatus has two conducting or leakage paths – one through the insulating material and the other over its surfaces. By providing a third test terminal in the path of the surface leakage, it is separated into two parts, forming a three-terminal network as shown in Fig. 25a. In practice, this third terminal may be provided as shown in Figures 26 to 38.

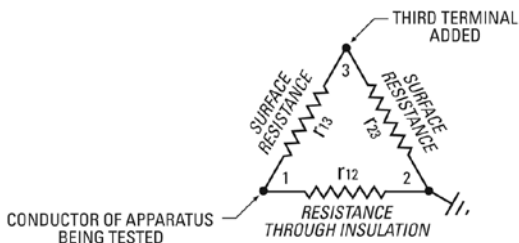

Figure 25a

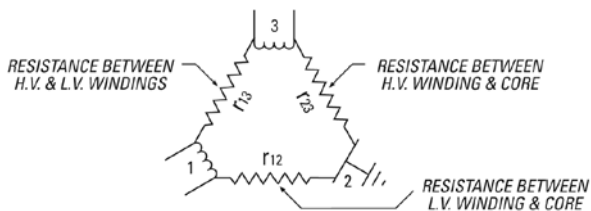

Figure 25b

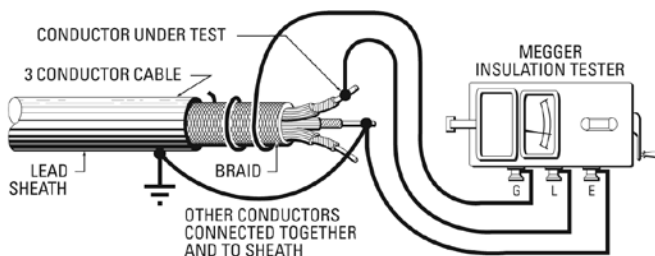

Figure 26-Showing how to use the Guard terminal to eliminate the effects of surface leakage across exposed insulation at one end of a cable. See also Figures 28, 30 and 31.

There are also cases, such as found in two winding transformers or multi-conductor cables, where a three-terminal network is formed as shown in Fig. 25b. Figures 30 and 33 and others show practical applications of this form of three-terminal network.

In making a three-terminal test involving only one measurement, the Line terminal of the Megger instrument is connected to Terminal 1, Fig. 25a, the Guard terminal to Terminal 3, and the Earth terminal to Terminal 2. This will give the true value of $r_{12'}$ provided r_{23} and r_{13} are not too low in value. The leg $r_{23'}$ which is connected across the Megger instrument generator, should be about 1 megohm or higher to prevent excessive load on the generator, and maintain satisfactory generator voltage.

In using the Guard terminal, particularly in the case of motor-driven or rectifier-operated Megger instruments, also make certain that there is no chance of an arc-over between the guarded terminal of the sample and ground. Such an arc-over may cause undesirable arcing at the commutator of the instrument generator.

The leg $r_{13'}$ which shunts the Megger deflecting coil, should be at least 100 megohms for a measuring accuracy of approximately 1%. The 1% accuracy figure is based on the R' ballast resistor being 1 megohm, which is typical. For more precise determinations of accuracy, obtain the exact value of R' by writing to Megger and giving the serial number of the instrument in use.

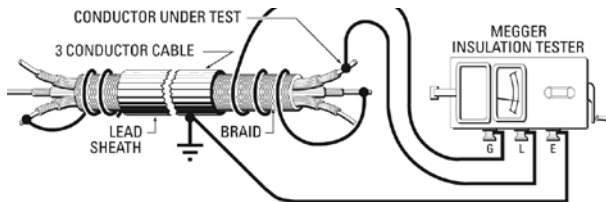

Figure 27-Showing how to use the Guard connection to eliminate the effects of surface leakage across exposed insulation at both ends of a cable when a spare conductor in the cable is available for completing the Guard connection.

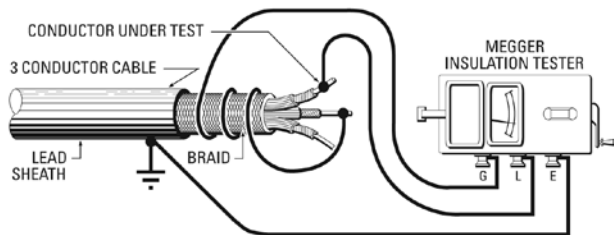

Figure 28-Showing use of the Guard connection to eliminate the effect of leakage to ground, as in Figure 26, and also the effect of leakage to adjacent conductors. Note that the Guard wire is wrapped around the exposed insulation and also is connected to the adjacent conductors.

Do not confuse this diagram with Figure 26, where the Guard wire goes only to the exposed insulation, and the adjacent conductors are grounded.

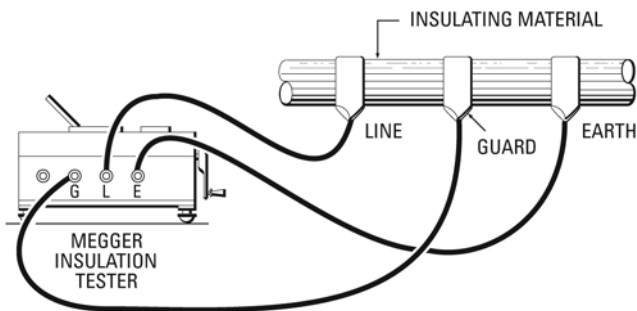

Figure 29-To eliminate the effect of surface leakage in measuring the true resistance of an insulating member, such as a lift rod in a circuit breaker.

The highest accuracy is desired in cases as shown in Fig. 25a, or where the true resistance of each leg is wanted as in the case of Fig. 25b, three measurements are required and the following equations are used:

$$r_{12} = \frac{R_{12} R_{13} - (R')^2}{R_{13} + R'}$$

$$r_{23} = \frac{R_{12} R_{23} - (R')^2}{R_{12} + R'}$$

$$r_{13} = \frac{R_{12} R_{13} - (R')^2}{R_{12} + R'}$$

where R_{12} , R_{23} and R_{13} are the actual readings in megohms measured across the terminals of the network which are connected to the Line and Earth terminals of the Megger instrument with Terminals 3, 1 and 2 respectively connected to the instrument Guard terminal. R' is the value of the ballast resistance in megohms of the instrument in use. In making these three measurements, do not connect the Line terminal of the instrument to the grounded terminal of the network, as any leakage over the instrument case between the Earth terminal and ground will shunt the resistance being measured.

BUSHINGS, POTHEADS AND INSULATORS

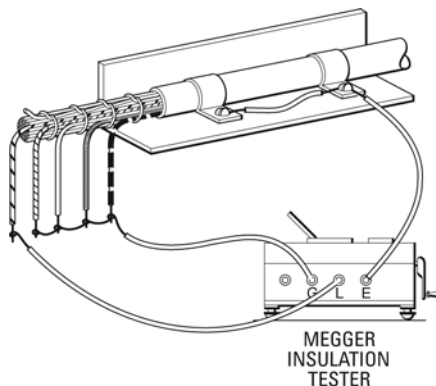

Figure 30-Connections for testing insulation resistance between one wire and ground, without being affected by leakage to other wires. Note use of Guard connection.

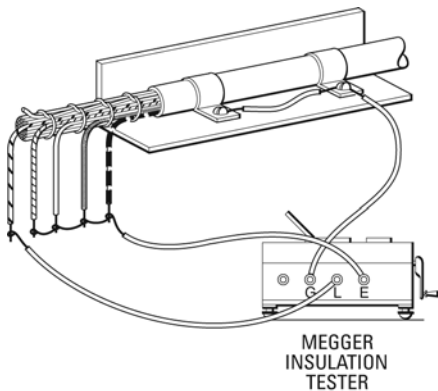

Figure 31-Connections for testing insulation resistance between one wire and all other wires connected, without being affected by leakage to ground.

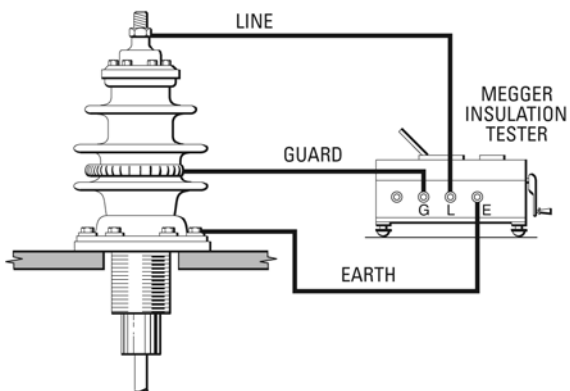

Figure 32-Showing use of spring collar as a Guard connection to eliminate the effects of surface leakage. The device under test must be disconnected from all other equipment.

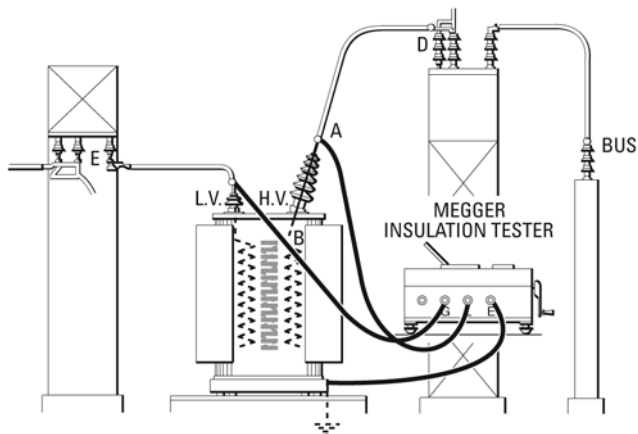

Figure 33-Connections for testing insulation resistance of a transformer high voltage winding and bushings, and the high tension disconnect switch in parallel with reference to ground but without being affected by leakage between the high and low voltage windings through use of the Guard connection.

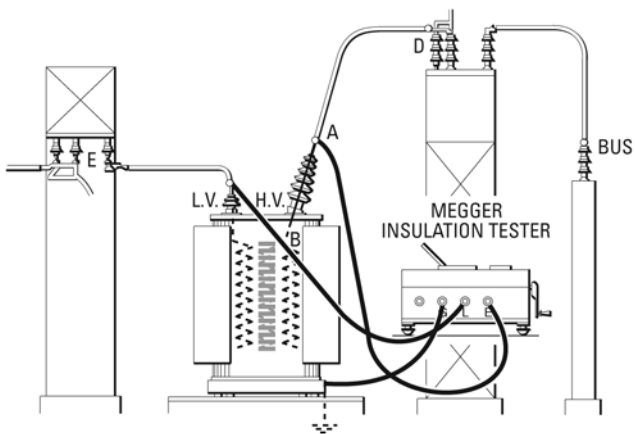

Figure 34-Connections for testing insulation resistance between high and low voltage windings without being affected by leakage to ground.

OUTDOOR OIL CIRCUIT BREAKERS

The four illustrations (Fig. 35 through 38) show the usual methods of testing bushings and associated parts of an outdoor oil circuit breaker, and the accompanying table indicates the test procedure by steps.

If the test values are below 10,000 megohms in any of the four steps, the tank should be lowered or drained so that the excessive losses can be isolated by further tests and investigations. If the test values are below 50,000 megohms in test #1, the trend of the condition of the particular bushing involved should be watched by making more frequent tests.

Test	Breaker Position	Bushing Energized	Bushing Guarded	Bushing Grounded	Part Measured
1	open	1 (2 to guard)	1	Bushing 1
2	open	1	1	2	Bushing 1 in parallel with cross member
3	open	1 & 2	1 & 2	Bushing 1 & 2 in parallel
4	close	1 & 2	1 & 2	Bushing 1 & 2 in parallel with lift rod

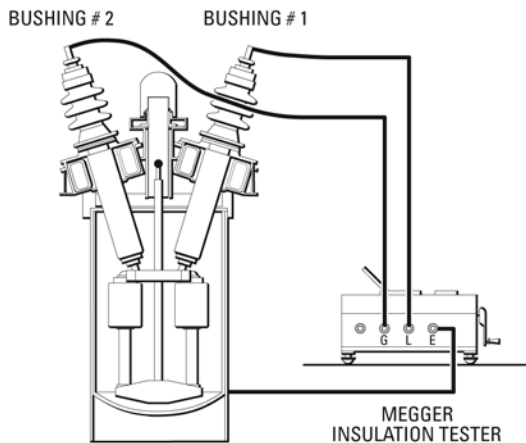

Figure 35-Step 1

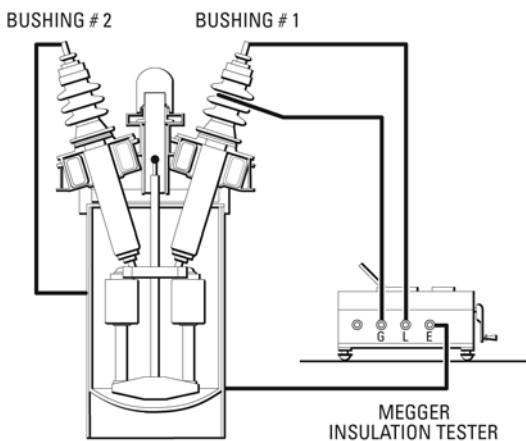

Figure 36-Step 2

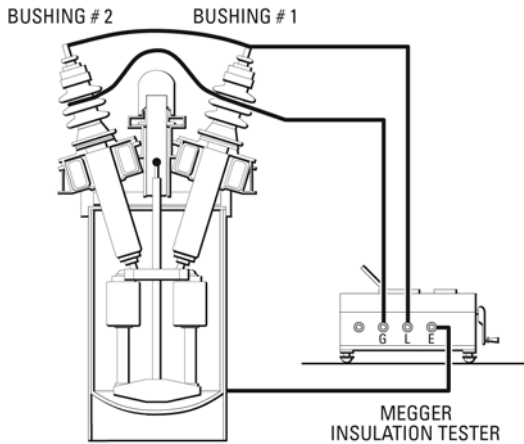

Figure 37-Step 3

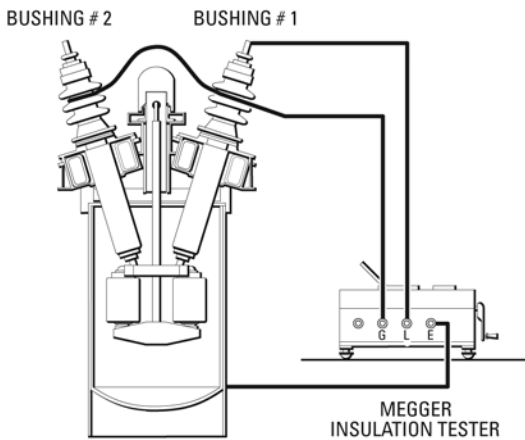

Figure 38-Step 4

SETTING UP A MAINTENANCE PROGRAM

To start insulation testing there is one general rule: Put first things first. That is, review all the electrical equipment and classify it as to relative importance. For example, if that AC motor failed in department A, how would it affect overall plant production? Your production people can certainly help in this and should be vitally interested in the idea.

If time permits at the start, test every piece of electrical equipment and make out a record card. Possibly at first you will have to combine several units but it will pay in the long run to have test records for each individual unit. Then, if insulation weaknesses do show up, your job of tracking down the offending part will be easier.

Shown in Fig. 40 is one form of test record card, which is available from Megger. Following is the type of information, which becomes more valuable to you as tests are repeated at intervals:

1. Name and location of the equipment
2. Dates and values of test results (record actual reading at the time of test)
3. Range, voltage, and serial number of the Megger instrument used
4. Temperature of the apparatus (also, particularly for large units, wet and dry bulb temperatures – for humidity and dew-point determinations)
5. Insulation resistance measurement corrected for temperature
6. A plot of consecutive readings to show trend and enable you to anticipate failures

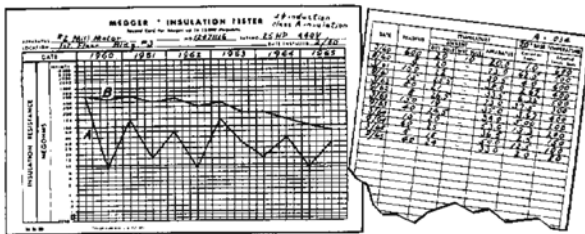

Figure 40

HOW OFTEN SHOULD YOU TEST?

That depends upon the size and complexity of your plant. Even identical units can differ in the required check periods; experience is your best guide. In general, however, working apparatus – motors, generators etc. – are more likely to develop insulation weaknesses, as compared to wiring, insulators and the like. A test schedule for working equipment should be established, varying from every 6 to 12 months, depending on the size of equipment and severity of the surrounding atmospheric conditions. For wiring and the like, tests once a year are generally sufficient, unless the plant conditions are unusually severe.

MEGGER 5 kV & 10 kV INSULATION TESTERS

Where critical, high-capital equipment is involved, the introduction of new and improved insulating materials is re-writing the book on insulation testing. Equipment with operating voltages above 1 kV requires commensurately higher test voltages. Modern materials, when new or early in their life cycles, can have insulation values into ranges that were previously unmeasured. Your old insulation tester may not be fully adequate to meet the demands of a rigorous and thorough program of preventive/predictive maintenance on modern equipment.

To be fully in conformance with the most modern testing requirements, Megger offers a family of the highest quality insulation testers at voltages above 1 kV. At the core of high-voltage testing...5 kV...the MIT510 and MIT520 afford the highest level of quality testing along with prime safety, convenience and portability. MIT510 offers selectable test voltages at 250, 500, 1000, 2500, and 5000 V, thereby making the tester suitable for applications otherwise performed with a standard handheld model, in addition to the more demanding high-voltage applications. The MIT520 increases the functionality by permitting test voltage to be set in any 10 V increment from 50 V to 1 kV, then in 25 V steps all the way to 5 kV. The testers measure to 15 Tera-ohms, thereby making them fully suitable for critical installation tests and establishment of reliable base data for new high-capital equipment. Test results are displayed on Megger's patented electronic digital/analog arc, thereby affording the precision and assurance of a digital reading combined with the tell-tale pointer travel normally reserved for mechanical movements.

The new 5 kV insulation resistance testers from Megger are designed specifically to assist you with the testing and maintenance of high voltage electrical equipment.



- Mains or battery powered
- Digital/Analog backlit display
- Selectable test voltage from 250 to 5000V
- Automatic IR test
- Measures to 15 T Ω
- Complete with calibration certificate

Megger MIT510

The new 10 kV insulation resistance testers from Megger are also designed specifically to assist you with the testing and maintenance of high voltage electrical equipment.

All cases are rugged and easy to carry, being made of tough polypropylene and achieving an ingress protection rating of IP65.

- Mains or battery powered
- Digital/analog backlit display
- Variable test voltage from 50 V to 10 kV
- Automatic IR, PI, DAR, SV and DD tests
- Measures to 15 T Ω (5 kV) and 35 T Ω (10 kV)
- RS232 and USB download of results



Megger MIT1020

MEGGER MIT400 SERIES



Megger MIT410

A new line of high performance testers rated to CAT IV 600 V provides greater safety when testing at higher voltage levels.

The MIT400 Series offer test voltages from 10 to 1000 V, and includes a special user-selectable 10 V to 100 V in 1 V increments tester for low voltage insulation testing requirements. The units include an exceptional insulation resistance measurement range that extends from 20 Gigohms to 200 Gigohms, with the option to display the insulation test voltage or leakage current on the secondary display.

Timed insulation testing for PI and DAR testing is available on certain models. A 200 mA continuity measurement is available with a 0.01-ohm resolution for fast accurate cable resistance measurement. This can be set to 20 mA where conformity to electrical testing regulations is not required, extending battery life.

MEGGER MIT300 SERIES

The MIT300 Series is designed along Megger's familiar principle of ascending features with no loss of basic quality. Five models comprise the family, each built on a basic design ensuring the quality and reliability that are Megger's trademarks. MIT300 is the simplest model, offering core functions of highest quality but no additional features that may prove redundant in basic applications. For applications where a 1 kV test must be avoided, the MIT300 offers a 250 and 500 V test only. Combined with continuity and voltage warning, plus all the convenience and safety features that distinguish the family, this is the model of choice for the simplest applications.

If basic function is still the goal but a 1 kV test required, the MIT310 is the perfect fit. With the possibility of working at higher voltages, safe operation has been further enhanced by the inclusion of a default voltmeter.



Megger MIT300 Series

For those who prefer the traditional mechanical analog type of instrument, the MIT310A offers everything in the MIT310, but with a moving coil display. The analog display is enhanced by black decals on a white background, to give high contrast and improved visibility.

The family is completed by the full-featured MIT320 and MIT330. The former adds a kilohm range for measurements between the extremes of continuity and high voltage. With this feature, measurements can be made continuously from 0.01 Ω to 999 M Ω . A backlit display is further enhanced by backlit selections, to make both the setup and results visible in poor light. The MIT320 also offers audible alarms on both the continuity and megohm ranges, adjustable across the entire range.

Finally, the MIT330 offers everything described in the MIT320, plus storage of up to 1000 results, downloading through a USB port via included software, and a display indication of remaining memory.



Megger MIT230

MEGGER MIT200 SERIES

Need only basic 1 kV insulation and continuity testing, with economy a paramount consideration? No need to sacrifice! Megger offers the only top quality line of inexpensive testers on the market...the MIT200 Series. Though designed with economy in mind, these testers offer no loss of the quality and reliability that the name Megger implies. Furthermore, there has been no sacrifice of safety, which is a serious problem with inexpensive testers that have cut cost at the risk of arc flash and operator error.

Four models are available, differing only in the test voltages offered: MIT200 is a 500 V model for standard applications; MIT210 is a 1 kV model where higher test voltage is in order; MIT220 offers two voltages, 250 and 500, for more sensitive applications where a 1 kV test is to be avoided; for full-spectrum applications, MIT230 offers all three voltages, 250, 500 and 1 kV.



A Stitch in **TIME**

Megger makes more than just insulation resistance testers

Megger also makes high quality instruments for the following electrical testing applications:

- Earth/Ground Testing
- Relay Testing
- Oil Testing
- Circuit Breaker Testing
- Power Quality Analysis
- Low Resistance Testing
- Battery Testing
- Watthour Meter Testing
- Transformer Testing
- Cable Fault Testing
- Power Factor Testing
- Hi Pot Testing

Megger manufactures electrical test and maintenance instruments for electric power, process manufacturing, building wiring, engineering services and communications.



Megger[®]