



**Test Equipment  
Depot**  
1-800-517-8431

99 Washington Street  
Melrose, MA 02176  
Fax 781-665-0780  
TestEquipmentDepot.com

**YOKOGAWA** 

# Handy Calibrator

## CA150

### Multi-functional Hand-held Calibrator

- Highly accurate within 0.02% of the DC voltage range for source and measure
- Source and measurement can be performed simultaneously.
- Vertical body with large-screen display
- Loop power supply function (24 VDC at a load of max 22 mA)  
It is possible to measure current in the mA range while supplying power.
- Sink function
- Sweep functions that allow 3 types of continuous outputs:  
Step sweep function  
Linear sweep function  
Program sweep function



Yokogawa Meters & Instruments Corporation

Bulletin CA150-E

# CA150

Handy Cal

**Multi-functional and high-precision calibrator that can be used to calibrate and test industrial process devices and various electronics equipment**

## Functions/Features

### Vertical hand-held calibrator

Easy-to-hold vertical body is designed to make it intuitively easy to operate, as individual functions are accessed directly by pressing assigned keys.

Using the main body case (model No. 93027) (sold separately), you can hang CA150 to your body or a handrail to keep it handy.

### Simultaneous source and measurement for process devices

In conventional calibration applications, multiple devices such as a standard generator, dial resistor and multi-meter were required. Now with a single CA150 unit, it is possible to perform operation check at regular inspection and maintenance of thermocouples, RTDs and instruments, as well as maintenance and equipment diagnosis of process devices such as transmitters, thermostats and signal converters.

### Loop power supply function

It is possible to measure generated current signals while supplying loop power 24 VDC from a two-wire type transmitter (up to 22 mA DC).

### Highly accurate and multi-functional source and measurement

High accuracy: 0.02% for the source unit and 0.02% for the measurement unit

Source and Measurement functions: DCV voltage, DC mA, ohm, frequency and temperature (thermocouple, RTD) and 24 VDC power supply function for transmitters



## Two-wire Type Transmitter Applications

### Two-wire type transmitter (measurement function) application

#### Loop check function

Measures mA DC signals output while supplying transmitter power at 24 VDC.

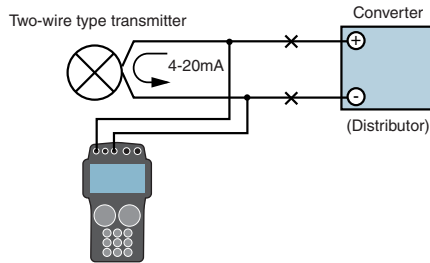

### Two-wire type transmitter (source function) application

#### Sink function

Receives current (Sink) from the power supply at voltages of up to 28 VDC and transmits mA DC signals to the loop.

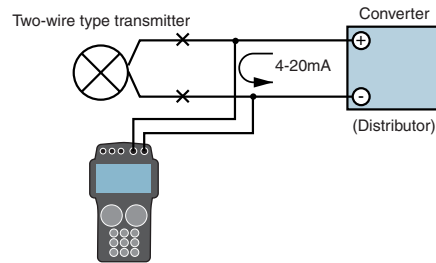

## Memory Functions

### Setting memory

This function saves/loads setting conditions.

Up to 21 data items can be stored.

Settings for (source/measurement) functions, ranges, generated values/measured values as well as setting mode conditions can be stored.

### Data memory

This function saves source and measure values displayed.

Up to 100 data items can be stored.

Storage date/time, (source/measurement) functions, ranges and generated values/measured values can be stored. Stored data can be checked on the display of the main unit as well as via communication.

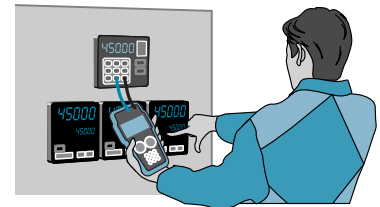

## Convenient Functions Useful in Field Tests

### Sweep Functions (Automatic Output Functions)

#### Step sweep function

This function changes the output in a staircase (step) pattern at fixed intervals.

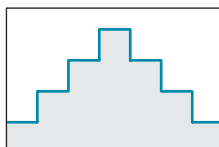

Step sweep

#### Linear sweep function

This function increases (or decreases) the output linearly with respect to the generated value.

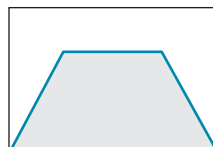

Linear sweep

#### Program sweep function

This function outputs source setting values stored by the data memory function sequentially in the order they are stored in the memory.

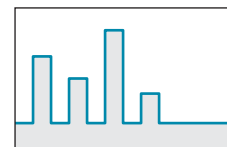

Program sweep

Test Equipment Depot - 800.517.8431 - 99 Washington Street Melrose, MA 02176

FAX 781.665.0780 - TestEquipmentDepot.com

# Specifications

## Source Unit

Accuracy=±(% of setting+μV, mV, μA, Ω and °C) at 23°C±5°C

	Range	Resolution	Source range	Accuracy	Remark
DC voltage	100mV	1uV	0 to ±110.000mV	±(0.02%+10uV)	Output resistance: Approx. 6.5Ω
	1V	10uV	0 to ±1.10000V	±(0.02%+0.05mV)	Maximum output: 10 mA, output resistance: Approx. 30 mΩ
	10V	0.1mV	0 to ±11.0000V	±(0.02%+0.5mV)	Maximum output: 10 mA, output resistance: Approx. 30 mΩ
	30V	10mV	0 to ±30.00V	±(0.02%+10mV)	Maximum output: 10 mA
DC current mA SINK	20mA	1uA	0 to +22.000mA	±(0.025%+3uA)	Maximum load: 24 V
	20mASINK	1uA	0 to -22.000mA	±(0.025%+6uA)	External power supply: 5 to 28 V
OHM	500Ω	0.01Ω	0 to 550.00Ω	±(0.02%+0.1Ω)	Excitation current: 1 to 5 mA or maximum output: 2 V <sup>2</sup>
	5kΩ	0.1Ω	0 to 5.5000kΩ	±(0.05%+1.5Ω)	Excitation current: 0.1 to 0.5 mA or maximum output: 2 V
	50kΩ	1Ω	0 to 55.000kΩ	±(0.1%+50Ω)	Excitation current: 0.01 to 0.1 mA or maximum output: 2 V
RTD *1	PT100	0.1°C	-200.0 to 850.0°C	±(0.025%+0.3°C)	Excitation current: 1 to 5 mA *2
	JPT100		-200.0 to 500.0°C		
Thermocouple *3	K	0.1°C	-200.0 to -100.0°C	±(0.02%+0.8°C)	*2 Excitation current Is: In the case of 0.1 mA to 1 mA or less, {0.05/ls (mA)} (Ω) or add {0.12/ls (mA)} (°C) *3 RJC accuracy is not included in the thermocouple generation accuracy. Reference temperature compensation is carried out by the separately sold RJ sensor. To compensate for the reference contact temperature in the output, add the RJ sensor accuracy. Output compensation: Every 10 seconds RJ sensor specifications Measured temperature range: -10 to 50°C Accuracy: 18 to 28°C: ±0.5°C (combination with the main unit) Other than above: ±1.0°C (combination with the main unit)
			-100.0 to 1372.0°C	±(0.02%+0.5°C)	
			-200.0 to -100.0°C	±(0.02%+0.6°C)	
	E	0.1°C	-100.0 to 1000.0°C	±(0.02%+0.4°C)	
			-200.0 to -100.0°C	±(0.02%+0.7°C)	
	J	0.1°C	-100.0 to 1200.0°C	±(0.02%+0.4°C)	
			-200.0 to -100.0°C	±(0.02%+0.8°C)	
	T	0.1°C	-100.0 to 400.0°C	±(0.02%+0.5°C)	
			-200.0 to 0°C	±(0.02%+1.0°C)	
	N	0.1°C	0.0 to 1300.0°C	±(0.02%+0.5°C)	
			-200.0 to 900.0°C	±(0.02%+0.5°C)	
	L	1°C	-200.0 to 0°C	±(0.02%+0.7°C)	
			0 to 400.0°C	±(0.02%+0.5°C)	
U	1°C	0 to 100°C	±(0.02%+2°C)		
		100 to 1768°C	±(0.02%+1.2°C)		
R	1°C	0 to 100°C	±(0.02%+2°C)		
		100 to 1768°C	±(0.02%+1.2°C)		
S	1°C	600 to 1000°C	±(0.02%+1.5°C)		
		1000 to 1820°C	±(0.02%+1°C)		
Frequency /pulse	100Hz	0.01Hz	1.00 to 110.00Hz	±0.05Hz	Output voltage: +0.1 V to +11 V (Zero-base waveform) Amplitude accuracy: ±10% Maximum load current: 10 mA Pulse cycle: 1 to 60000 cycles *4
	1000Hz	0.1Hz	90.0 to 1100.0Hz	±0.5Hz	
	10kHz	0.1kHz	0.9kHz to 11.0kHz	±0.1kHz	
	50kHz	1kHz	9kHz to 50kHz	±1kHz	
	CPM	0.1CPM	1.0 to 1100.0CPM	±0.5CPM	
	CPH	1CPH	10 to 11000CPH	±5CPM	

Temperature coefficient: Accuracy above x (1/10)/°C

The temperature coefficient is added in the ranges from 0 to 18°C and from 28 to 40°C

## Measurement Unit

Accuracy=±(% of reading+μV, mV, μA, Ω or dgt(digit)) at 23°C±5°C

	Range	Resolution	Measurement range	Accuracy	Remark
DC voltage	500mV	10uV	0 to ±500.00 mV	±(0.02%+50uV)	Input resistance: 1000 MΩ or more
	5V	0.1mV	0 to ±5.0000V	±(0.02%+0.5mV)	Input resistance: Approx. 1 MΩ
	35V	1mV	0 to ±35.000V	±(0.025%+5mV)	
DC current	20mA	1uA	0 to ±20.000mA	±(0.025%+4uA)	Input resistance: Approx. 20Ω or less
	100mA	10uA	0 to ±100.00mA	±(0.04%+30uA)	
OHM	500Ω	0.01Ω	0 to 500.00Ω	±(0.055%+0.075Ω)	Measurement current: Approx. 1 mA
	5kΩ	0.1Ω	0 to 5.0000kΩ	±(0.055%+0.75Ω)	Measurement current: Approx. 100 μA
	50kΩ	1Ω	0 to 50.000kΩ	±(0.055%+10Ω)	Measurement current: Approx. 10 μA
RTD *5	PT100	0.1°C	-200.0 to 850.0°C	±(0.05%+0.6°C)	*5 At three-wire type measurement
	JPT100		-200.0 to 500.0°C		
Thermocouple	K	0.1°C	-200.0 to 1372.0°C	±(0.05%+1.5°C)/-100°C or more ±(0.05%+2°C)/-100°C or less	A temperature coefficient is added if the display of the temperature monitor is outside the range of 18 to 28°C.
			-200.0 to 1000.0°C		
			-200.0 to 1200.0°C		
	T	0.1°C	-200.0 to 400.0°C		
			-200.0 to 1300.0°C		
	L	1°C	-200.0 to 900.0°C		
			-200.0 to 400.0°C		
R	1°C	0 to 1768°C	±(0.05%+2°C)/100°C or more		
		0 to 1768°C	±(0.05%+3°C)/100°C or less		
S	1°C	600 to 1800°C	±(0.05%+3°C)/100°C or less		
		600 to 1800°C	±(0.05%+3°C)/100°C or less		
Pulse	100Hz	0.01Hz	1.00 to 110.00Hz	±2 dgt	Maximum input: 30 V Sensitivity: 0.5 Vp-p Input resistance: 100kΩ Contact input: Up to 100 Hz
	1000Hz	0.1Hz	1.0 to 1100.0Hz		
	10kHz	0.001kHz	0.001 to 11.000kHz		
	CPM	1CPM	0 to 100000CPM		
	CPH	1CPH	0 to 100000CPH		
Loop power supply	24V LOOP			24V±2V	Maximum load current: 22 mA

Temperature coefficient: Accuracy above x (1/10)/°C

The temperature coefficient is added in the ranges from 0 to 18°C and from 28 to 40°C

## General Specifications

### Specifications common to source and measurement

#### Communication functions

Serial interface  
RS232 D-Sub 9-pin connector

#### Memory functions

Data can be stored and loaded in setting memory (setting data) and data memory (source/measurement).

	Items stored/loaded	Number of data items that can be stored
Setting memory	(source/measurement) functions, ranges, generated values/measured values and setting mode conditions	21set
Data memory	Storage date/time, (source/measurement) functions, ranges and generated values/measured values	100set

### Common source specifications

#### Power supply

6 AA size alkaline batteries  
AC adapter (sold separately) or dedicated NiMH battery (sold separately)  
AC adapter specification:  
100 to 240 VAC, 50/60 Hz, 1.4 A  
OUTPUT: 12 VDC, 3 A

Battery life Conditions: Simultaneous Source/measurement Output of 5 V DC/10 kΩ or more  
Size AA alkaline batteries  
When 6 batteries are used:  
Approx. 8 hours  
When NiMH battery is used:  
Approx. 10 hours

Auto power-off  
Approx. 10 minutes;  
it can be canceled by setting.

#### Insulation resistance

Between input terminal and output terminal: 500 VDC, 50 MΩ or more

Withstand voltage Between measurement terminal and generation terminal: 350 VAC, 1 minute

Operating temperature/humidity range: 0 to 40°C, 20 to 80%RH (no condensation)

Storage temperature range: -20 to 60°C 90%RH or less (no condensation)

External dimensions: Approx. 251 x 124 x 70 mm

Weight: Approx. 1000 g

#### Accessories

Lead cable for generation: 1 set  
Lead cable for measurement: 1 set  
Carrying case: 1  
Terminal adapter: 1  
Size AA battery: 6  
Instruction Manual: 1  
Fuse for measurement: 1 (spare)

#### Conforming Standards

Safety EMC  
EN61010-1  
EN 61326 Class B; EN 55011 Class B Group1  
EN 61000-3-2; EN 61000-3-3, EN61326

## ● Model Name

Product name	Model name
Handy Calibrator	CA150

With the main body case (model name: 93027)  
(sold separately) installed  
Includes strap and accessory storage case



The main body case is designed to make it easy to hold with one hand.

## ● External Dimensions

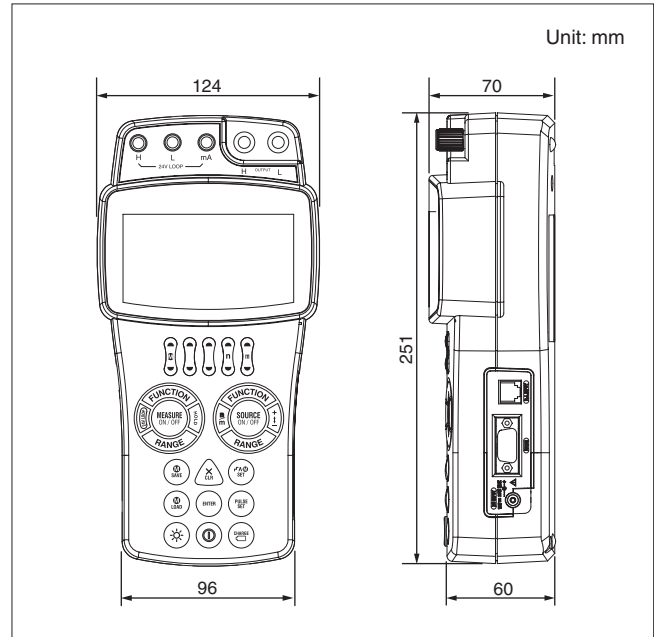

## ● Supplied Accessories

Product name	Lead cable for source	Lead cable for measurement	Carrying case	Terminal adapter
Model name	98020	RD031	93026	99022
Remark	One set of 1 red and 2 black cables Length: Approx. 1.7 m	One set of 1 red and 1 black cables Length: Approx. 1.0 m	Lead cables for source/measurement, terminal adapter, 6 spare batteries, fuse, AC adapter and instruction Manual can be stored.	Used for temperature measurement.

## ● Optional Accessories (sold separately)

Product name	AC adapter	RJ sensor	Accessory storage case	NiMH battery	Main body case
Model name	94010	B9108WA	B9108XA	94015	93027
Remark	-D For UL/CSA Standard -F For VDE Standard -H For GB Standard -R For SAA Standard -S For BS Standard	For reference junction compensation	Lead cables, RJ sensor, etc. can be stored.	NiMH battery Dedicated	With strap and accessory storage case

**YOKOGAWA**   
Yokogawa Meters & Instruments Corporation

World Wide Web site at  
<http://www.yokogawa.com/MCC>

### ⚠ NOTICE

- Before using the product, read the instruction manual carefully to ensure proper and safe operation.