

REGULATED DC POWER SUPPLIES

Regulated DC Power Supplies

PD-A/AD SERIES

Meter display

18V/10A

PD18-10A

18V/20A

PD18-20A

18V/30A

PD18-30A

36V/10A

PD36-10A

36V/20A

PD36-20A

56V/6A

PD56-6A

56V/10A

PD56-10A

110V/3A

PD110-3A

110V/5A

PD110-5A

Digital display

18V/10A

PD18-10AD

18V/20A

PD18-20AD

18V/30A

PD18-30AD

36V/10A

PD36-10AD

36V/20A

PD36-20AD

56V/6A

PD56-6AD

56V/10A

PD56-10AD

110V/3A

PD110-3AD

110V/5A

PD110-5AD

OUTLINE

The PD-A/AD Series power supplies are DC constant-voltage (CV), constant-current (CC) power supplies with variable output level featuring the use of the phase control method and high reliability. Inheriting the reliability and accuracy of the highly approved PD Series and incorporating a wide variety of protection facilities, the PD-A/AD Series power supplies have been designed with emphasis on the ease of operation and safety in use as research and experiment power supplies or long aging system power supplies. With 9 combinations of different voltage/current capacity values and the meter indication type and digital indication type models available for each of them, a total of 18 models offer a wide variation which can be selected according to applications.

Test Equipment Depot

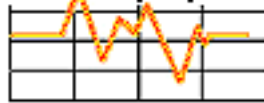

1-800-517-8431

99 Washington Street
Melrose, MA 02176
FAX 781-665-0780

TestEquipmentDepot.com



PD-A/AD SERIES

FEATURES

High Stability, Large Capacity

A unique phase control method which uses a built-in pre-regulator ensures fast response and efficient high-stability supply of high currents.

Low Ripple, Low Noise

The unique phase control method is combined with a choke-input type smoothing circuit to provide excellent input and load variation rates, low ripple and low noise.

High-Accuracy Voltage and Current Settings

The output voltage as well as the output current can be set using 10-turn potentiometers, enabling smooth, fine setting.

Remote Sensing

This function compensates for the voltage drop at the load terminals which is caused by resistance of leads between the PD-A Series supply output terminals and the load and by output terminal contact resistance.

Remote Control

The output voltage and current can be controlled by means of an external DC voltage or resistance. In addition, it is also possible to remote control the OUTPUT ON/OFF by means of a contact switch.

Voltage/Current Limiting

A V/I CHECK switch is provided to allow setting the constant voltage and constant current setting values. The voltage and current values can be set and checked even while the output is ON.

Parallel Operation

By connecting the PD-A Series power supplies of the same model in a master-slave configuration, a single master can control all of the slave supplies. This parallel operation makes it possible to increase the output current.

Series Operation

The output voltage can be increased by series connection. A series connection in the master-slave mode of operation is also possible, with which a single master can control all of the slave supplies (provided that the allowable grounding voltage is within ± 250 V.)

GP-IB System Compatibility

The voltage and current can be set with high accuracy through GP-IB by connecting the optional GP-610D GP-IB adaptor. The OUTPUT ON/OFF can also be controlled through the GP-IB if the OP-12 EXT I/O unit (factory option) is added.

OUTPUT ON/OFF

The OUTPUT switch allows you to turn the output voltage on and off electronically. This can also be controlled externally by means of a contact switch.

OVP (Over-Voltage Protection)

The OVP protects the load from excessive voltage by switching the power off instantaneously in cases of operational mistakes or

unexpected accidents. The OVP setting voltage can be displayed by pressing the OVP CHECK switch, and the setting can be made using a semi-fixed potentiometer on the front panel. The OVP setting voltage can be set or checked even while the output is on, without interrupting the use of the power supply.

OCP (Over-Current Protection)

The OCP protector circuits detects output current level above about 120% of the rated current and switches the power off.

OHP (Over-Heat Protection)

The OHP protector circuit detects the rise of heat sink temperature at about 100degree C and switches the power off.

LED Indicators

The green LED lights during constant-voltage operation and the red LED lights during constant-current operation.

Output

The output is supplied from 3 terminals based on the floating method.

Remote Control Operations

Remote Sensing

This function compensates for the voltage drop at the load connection terminals which is caused by resistance of leads between the PD-A Series supply output terminals and the load and by output terminal contact resistance.

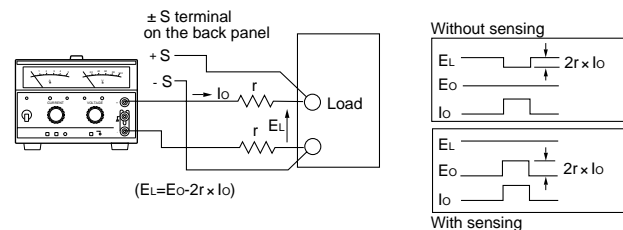

Control by an External Voltage

An externally-applied voltage (0 to 10 V) can be used to control the output voltage and current.

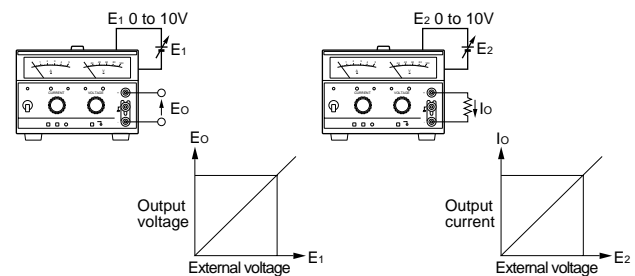

REGULATED DC POWER SUPPLIES

Single-Controlled Parallel Operation

It is possible to connect the several power supplied of the same model in parallel to increase the output current capacity. One unit (the master) can be used to control all the other units (slaves) in a master-slave mode of operation.

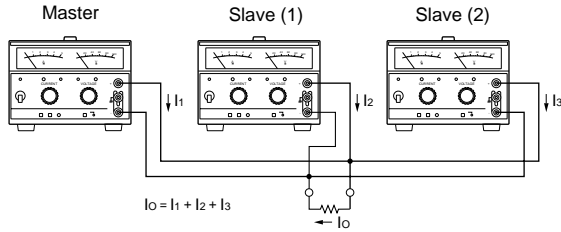

Control by an External Resistance (1)

An externally-applied resistance (0 to 10 kΩ) can be used to control the output voltage and current.

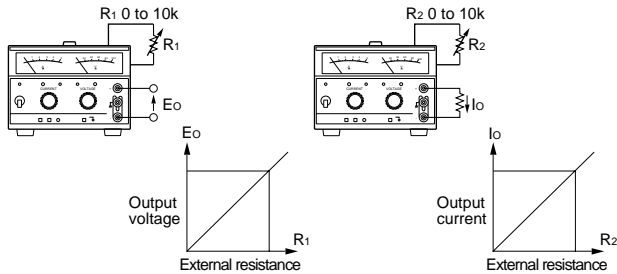

OUTPUT ON/OFF Control with External Contact

The output can be switched on and off according to the opening and shorting of an external contact.

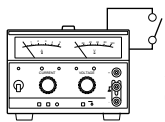

Shorted: OUTPUT OFF. Open: OUTPUT ON.
(The front-panel OUTPUT ON/OFF switch should be left to ON.)

Series Operation

All of the PD-A Series power supplies can be connected in series provided that the grounding voltage is within ± 250 V.

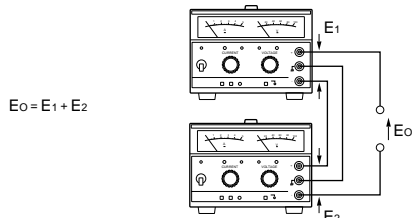

Single-Controlled Series Operation

It is possible to connect several power supplies of the same model in series to increase the output voltage capacity. One unit (the master) can be used to control all the other units (slaves) in a master-slave setup.

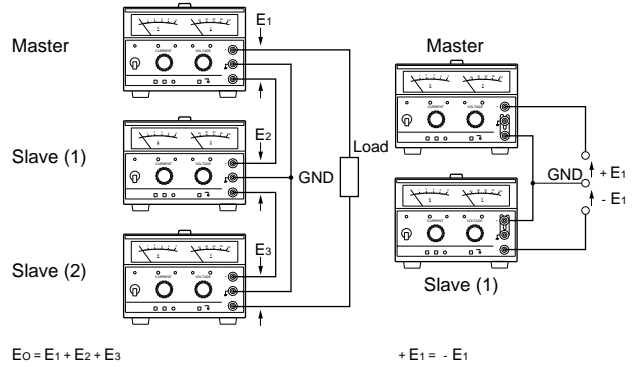

Control by an External Resistance (2)

An externally-applied resistance (0 to infinity) can be used to control the output voltage.

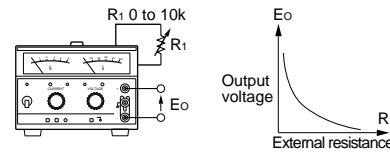

GP-IB Control

Used in combination with the optional GP-610D GP-IB adaptor, the PD-A/AD Series can be GP-IB controlled from a computer.

OP-12 (with option)

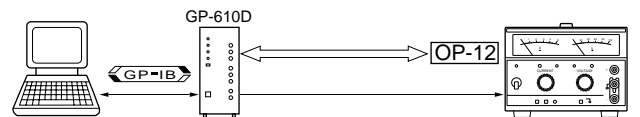

OP-12 (without option)



Controllable Power Supply Operations from This Unit

		Voltage only	Current only	Both Voltage/Current	OUT PUT ON/OFF	CV CC and CC CV mode interrupt	POWER-OFF interrupt (OVP interrupt, etc.)
EXT I/O	With OP-12	;	;	;	;	;	;
	Without OP-12	;	;	;	X	X	X

Unit

PD-A/AD SERIES

GP-IB Adaptor

GP-IB Adaptor

GP-610D

The interface conforms to the IEEE-488-1978 and the SRQ (Service Request) function detects abnormality in the controlled power supplies to provide safety. With mutually insulated three D/A outputs, the GP-610D can control the voltage or current of up to 3 units of PD-A Series power supplies. Outputs A and B use 12-bit D/A converters with binary inputs for highly-accurate setting (while output C uses a 8-bit binary-input D/A converter.)



Case dimensions 68 (W) x 147 (H) x 251 (D) mm
 Maximum dimensions 73 (W x 161.5 (H) x 284 (D)mm
 Weight Approx. 2.3kg
 Accessories Instruction manual x 1,
 OP-14 x 1 set [3 pin (DIN 3-core arrow-shaped tip cable x 2/ (7pin DIN-7pin DIN cable) x 1]

GP-610D SPECIFICATIONS

Electrical specifications conform to IEEE488-1978
 Mechanical specifications conform to IEEE488-1978
 Interface function SH1, AH1, T6, L3, SR1, RL1, PP0, DC1, DT1, C0
 Address Any address from 0 - 30 can be set with the address switch
 Listen-only mode Can be set with L-ONLY switch
 Remote/local function Can be set with the Local switch.
 Service request function Input data format error, input setting error, and changes in CV/CC conditions of the supply being controlled; also breaker shutoff or power switch OFF status during abnormal voltage conditions of the supply being controlled.

Analog outputs

Channel	CHs A, B	CH C
Output voltage range	0 to ± 10 V (bipolar)	0 to + 10 V (monopolar)
Fullscale voltage variable range	±10V ±15%	+10V ±15%
Maximum output current	3mA	
D/A converter resolution	12-bit, 0.05% (4.8mV) (Linear 8 bit)	8-bit, 0.4% (39mV) (Linear 8 bit)
D/A converter accuracy (Ta=25°C)	0.025% (1/2LSB)	0.2% (1/2LSB)
Setting accuracy	0.0275%	0.22%
Output ripple & noise	300µVrms or less (10Hz to 1MHz)	
Input voltage variation	1.5mV or less (±10% fluctuate)	
Load variation	1.5mV or less (0-100% fluctuate)	
temperature coefficient	50ppm/°C(Typ.)	
Rise time	100µs or less (10 to 90%, 10kΩ load)	

Power source 00V ± 10%, 120, 220, 240V, (250V max) AC
 internally switchable, 50Hz/60Hz
 Power consumption 15W

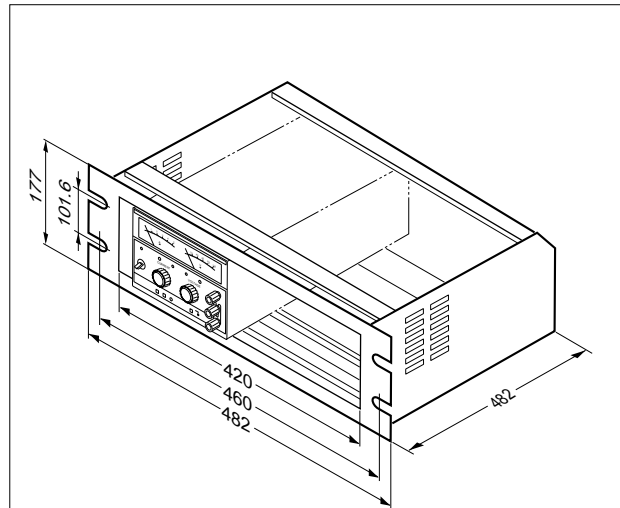

RK-601E

External dimensions : 482 (W) x 177 (H) x 482 (D) mm
 Weight: Approx. 6.5kg



CB-2420P



OP-12

RB-601 (1/2 Rack width)

RB-602 (1/6 Rack width)

Produced on receipt of an order

PD-A/AD SERIES REGULATED DC POWER SUPPLIES

REGULATED DC POWER SUPPLIES

SPECIFICATIONS

Model		PD18-10A/10AD	PD18-20A/20AD	PD18-30A/30AD
Output				
Output voltage		0 to 18V		
Output Current		0 to 10A	0 to 20A	0 to 30A
Voltage regulation characteristics				
Line regulation (with respect to $\pm 10\%$ variation in AC)		0.005% + 1mV		
Load regulation (with respect to change from 0 to 100%)		0.005% + 1mV	0.005% + 2mV	
Ripple/noise (10Hz to 1MHz) (typical)		0.5mVrms		
Transient response		50 μ s	100 μ s	
Remote control resistance/voltage		0 to 10k Ω /0 to 10V		
Current regulation characteristics				
Line regulation (with respect to $\pm 10\%$ variation in AC)		1mA	5mA	
Load regulation (with respect to change from 0 to 100%)		5mA		
Ripple/noise (10Hz to 1MHz) (typical)		3mA _{rms}	10mA _{rms}	
Remote control resistance/voltage		0 to 10k Ω /0 to 10V		
Protective circuit				
Temperature detection		Approx. 100 $^{\circ}$ C (power is shut off)		
Over-voltage protection		15% to 110% of rated output voltage (power is shut off)		
Input fuse rating (AC 100V/200V)		7A/4A	15A/8A	20A/10A
Meter and display				
A type	Voltmeter (2.5%) F.S.	18V		
	Ammeter (2.5%) F.S.	10A	20A	30A
AD type	Digital voltage display	3-1/2 digits, 19.99V, 199.9V (F.S.) two automatically switched ranges		
	Digital current display	3 digits or 3-1/2 digits, fixed range $\pm(0.5\%$ of rdg +1 digit) 19.99A (F.S.) 99.9A (F.S.)		
Constant-voltage operation display		Green LED lights for CV		
Constant-current operation display		Red LED lights for CC		
Output ON display		Red LED lights when output is ON		
Added functions				
Output switch		Output switchable ON/OFF (Incase of the OFF position, set output		
Voltage/current check switch		Switch ON: indicates the regulated voltage or current		
Over-voltage protection preset		Switch ON: indicates the operating voltage setting of the over-voltage		
Remote sensing		Possible		
Series/Parallel control		Master- slave operation		
Operating environment				
Temperature/humidity for operation		0 to 40 $^{\circ}$ C, 80% or less		
Cooling system		Forced air (fan)		
Output polarity		Positive or negative side groundable		
Groundable voltage		± 250 V DC		
Power requirements/Others				
Voltage		100V/120V/200V/220V/240V AC, 50/60Hz		
Power consumption		Approx. 0.36kW	Approx. 0.62kW	Approx. 0.93kW
		Approx. 0.53kVA	Approx. 1kVA	Approx. 1.4kVA
Case dimensions (W x H x D) mm		208 x 147 x 300	208 x 147 x 420	208 x 147 x 457
Maximum dimensions (W x H x D) mm		208 x 168 x 346	208 x 168 x 483	208 x 168 x 520
(With power input connector mounted)		208 x 168 x 355	208 x 168 x 486	208 x 168 x 523
L1/L/L2 (mm)		23/300/23	28/420/35	28/457/35
Weight		Approx. 12kg	Approx. 19kg	Approx. 24kg

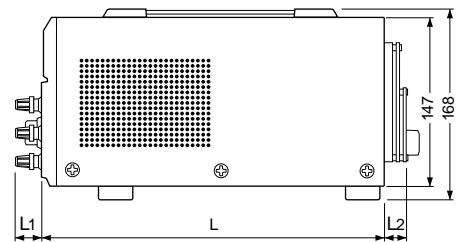
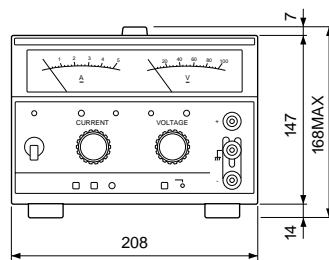

PD-A/AD SERIES

	PD36-10A/10AD	PD36-20A/20AD	PD56-6A/6AD	PD56-10A/10AD	PD110-3A/3AD	PD110-5A/5AD
	0 to 36V		0 to 56V		0 to 110V	
	0 to 10A	0 to 20A	0 to 6A	0 to 10A	0 to 3A	0 to 5A
	0.005±1mV	0.005 ± 2mV	0.005 ± 1mV	0.005 ± 2mV	0.005 ± 1mV	1mVrms
	50µs	100µs	50µs			
	1mA	5mA	1mA	3mA	1mA	
	3Arms	10Arms	2Arms	3Arms	1Arms	
	12A/6A	20A/10A	10A/5A	15A/8A	10A/5A	15A/8A
	36V		56V		110V	
	10A	20A	6A	10A	3A	5A
	± (0.1% rdg + 1digit) 23°C 5°C, PH80% or less					
	23°C±5°C, PH80% or less					
	19.99A	99.9A(F.S.)	99.9A(F.S.)			

voltage is indicated the meter or LED display)
 on the meter or LED display.
 protection circuit.

Approx. 0.56kW	Approx. 1kW	Approx. 0.5kW	Approx. 0.8kW	Approx. 0.5kW	Approx. 0.8kW
Approx. 0.83kVA	Approx. 1.5kVA	Approx. 0.8kVA	Approx. 1.25kVA	Approx. 0.8kVA	Approx. 1.25kVA
208 x 147 x 300	208 x 147 x 420	208 x 147 x 300	208 x 147 x 348	208 x 147 x 300	208 x 147 x 348
208 x 168 x 346	208 x 168 x 483	208 x 168 x 346	208 x 168 x 394	208 x 168 x 346	208 x 168 x 394
208 x 168 x 361	208 x 168 x 486	208 x 168 x 361	208 x 168 x 409	208 x 168 x 361	208 x 168 x 409
23/300/23	28/420/35	23/300/23	23/348/23	23/300/23	23/348/23
Approx. 14kg	Approx. 23kg	Approx. 14kg	Approx. 18kg	Approx. 14kg	Approx. 18kg

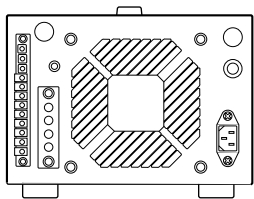

PD-A/AD SERIES REGULATED DC POWER SUPPLIES