



SecuriTEST™

User's Manual



**Test Equipment
Depot**
1-800-517-8431

99 Washington Street
Melrose, MA 02176
Fax 781-665-0780
TestEquipmentDepot.com

SecuriTEST User's Manual

Table of Contents

Safety Precautions.....	1
1. Safety Information.....	2
Warnings	2
Safety Information	3
Battery Precautions	5
2. Introduction	6
Features	6
Main Functions	6
Standard Accessories	7
Description of buttons/ports	8
3. Specifications	13
General Specifications	13
Meter Specifications	14
4. Functional Use	16
Power on/off	16
On Screen Display	16
Operation Modes	17
VIDEO Function	18
Digital MultiMeter Function	21
Warnings	28
PTZ Control	29
UTP Cable Tester	34
System Information	35
Main Settings	35

Before Using SecuriTEST

WARNING

Read the “Safety Information” portion of the manual before using the SecuriTEST CCTV tester.

This manual is for users of the IDEAL SecuriTEST multi-function CCTV tester. The manual describes the operation and function of the various features of SecuriTEST.

It is highly recommended that operators read the entire manual before using SecuriTEST to prevent damage to the tester or injury to the operator.



WARNING

⦿ SecuriTEST Safety Precautions

When using the Digital MultiMeter function to measure voltage or current, be sure that the input does not exceed the capabilities of the tester. Overloading the tester can cause damage or personal injury.

When measuring current of unknown values, always begin with the 10A mode, then step down to the 400mA input if necessary.

Environmental Limitations

Temperature: -10 to 50 degrees C

14 to 122 degrees F

Relative Humidity: 30-90%, non-condensing

DC input voltage: 12V +/-10%, 1A



1. Safety Information

Do not use the unit in damp conditions or environments where explosive gases may be present

Do not handle the unit with wet hands

Avoid dropping or causing mechanical shock to the unit

Do not expose the ports to liquids and avoid exposure to dust

Use only specified replacement fuses.

Do not use damaged test leads with the DMM function

Do not measure resistance on powered circuits

When using the DMM function, set the proper mode before connecting to the circuit under test

When measuring resistance, make certain that the circuit is de-energized before connecting the test leads to the circuit.

⦿ This page intentionally left blank



1. Safety Information

⚠ WARNING

⦿ Battery Charging Precautions

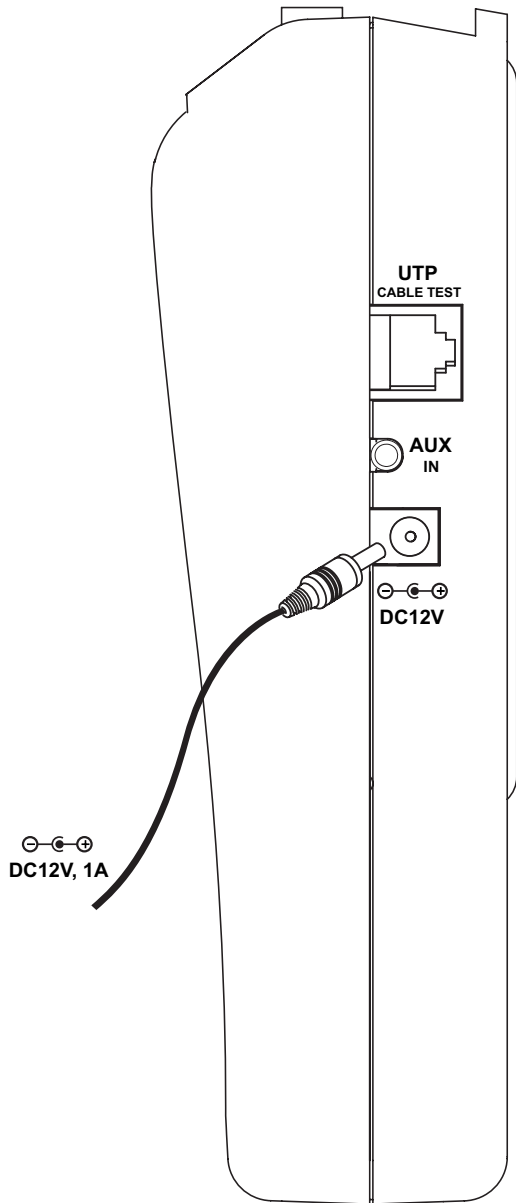

SecuriTEST is capable of recharging NiMH batteries installed in its battery compartment. Attach the included 12V adapter to the handset to charge the batteries. Charging time takes 8 hours. Operation time is approximately 3-4 hours on a fully charged set of batteries.

When using alkaline batteries the tester can run for approximately 2 hours on a new set of batteries.

When using alkaline batteries, set the switch inside the battery compartment to OFF to prevent accidental charging of alkaline batteries.

- Battery Precautions -

The following batteries can be used with SecuriTEST

- > AA size alkaline batteries
- > AA size rechargeable nickel metal hydrogen (Ni-MH) batteries

When charging batteries in SecuriTEST:

Place the CHARGE SWITCH to the "ON" position for charging.

The CHARGE SWITCH is located on the upper part of battery compartment. (Refer to the figure below)

The performance of batteries can be very different, depending on manufacturers. Please use any reputable brand for best performance.

Do not mix batteries of different manufacturers when charging batteries.

Make sure not to reverse the polarization of the batteries.

Do not short-circuit or disassemble batteries.

Make sure to check the polarization and the voltage and current ratings before charging batteries and disconnect the charger immediately should an abnormal situation arise.

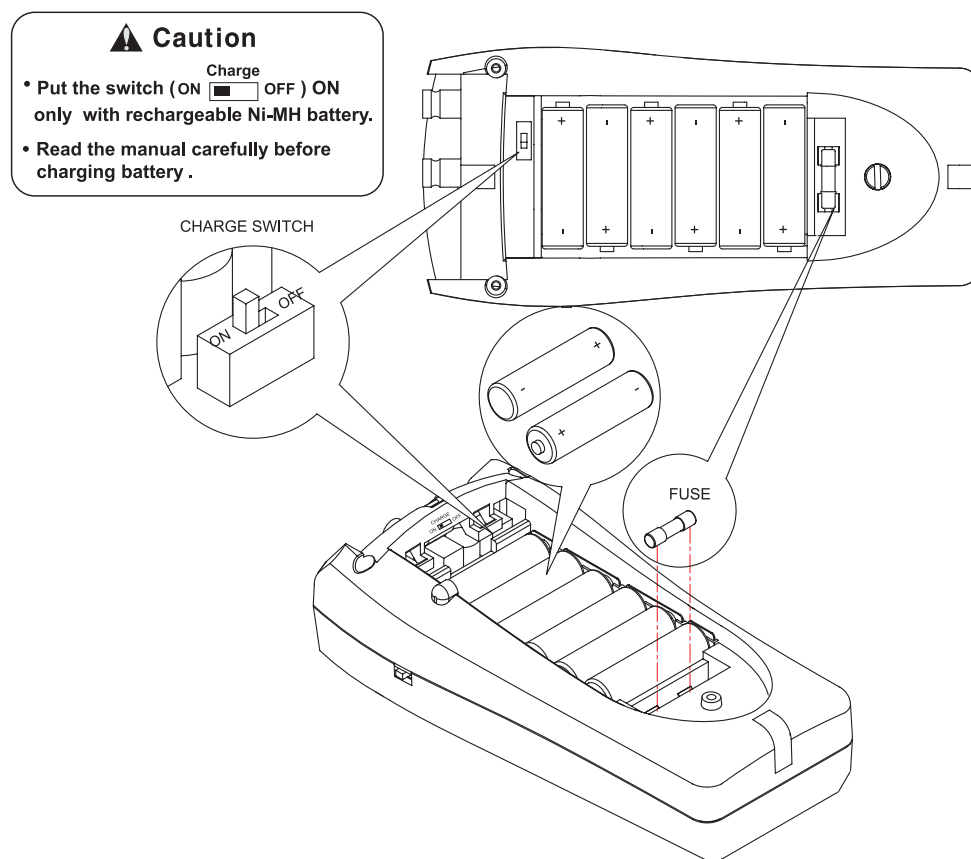



2. Introduction of SecuriTEST

FEATURES

SecuriTEST is a portable device for testing and troubleshooting various functions of CCTV cameras. It includes functions to test video image quality, control PTZ operation, analyze various PTZ protocols, generate video test patterns, test UTP cables and includes a full-function Digital MultiMeter.

All functions are controlled through the front keypad and on-screen display. For testing each function, set up modes and capacities to be tested, using the key pad located on the front part of Rapport337.

Main Functions of SecuriTEST

- | | |
|------------------|---|
| Video tester | <ul style="list-style-type: none">▶ The video signal and the quality of picture can be tested, and brightness, color and focus can also be adjusted while the image is being watched.▶ Video signal generator mode : Outputs color bars, Red Blue and Green to allow technicians to inspect video monitor or DVR. Supports both PAL & NTSC video signal formats. |
| Multimeter | <ul style="list-style-type: none">▶ Voltage, current, resistance and continuity can be tested. |
| PTZ Controller | <ul style="list-style-type: none">▶ The PTZ controller tests the motor control of the dome and the focus and zoom functions of the camera. Supports RS-485/422 communications protocols. |
| UPT Cable tester | <ul style="list-style-type: none">▶ The UTP cable check tests unshielded cables for continuity, opens, shorts and miswired pairs |

Standard Accessories

The following items are included with the SecuriTEST CCTV Tester.

- SecuriTEST Main Body
- User's Manual
- Test Lead Set (Red, Black)
- AC Adapter
- Rechargeable AA Nickel Metal Hydrogen (Ni-MH) Battery (6ea)
- Neck strap
- UTP test Terminator
- BNC Video Cable
- Car power jack

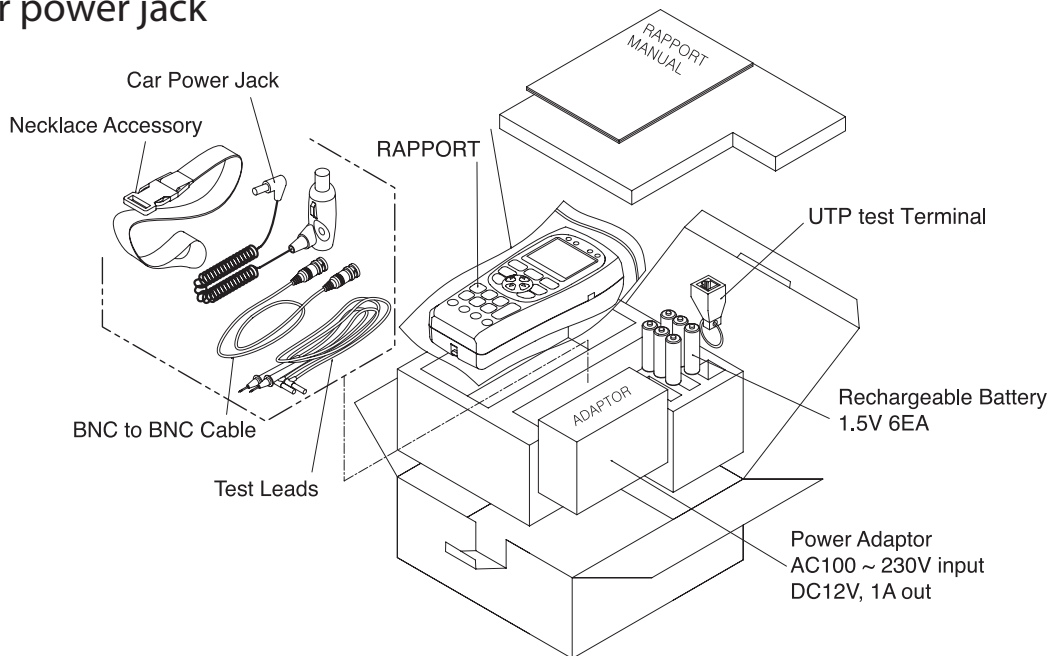







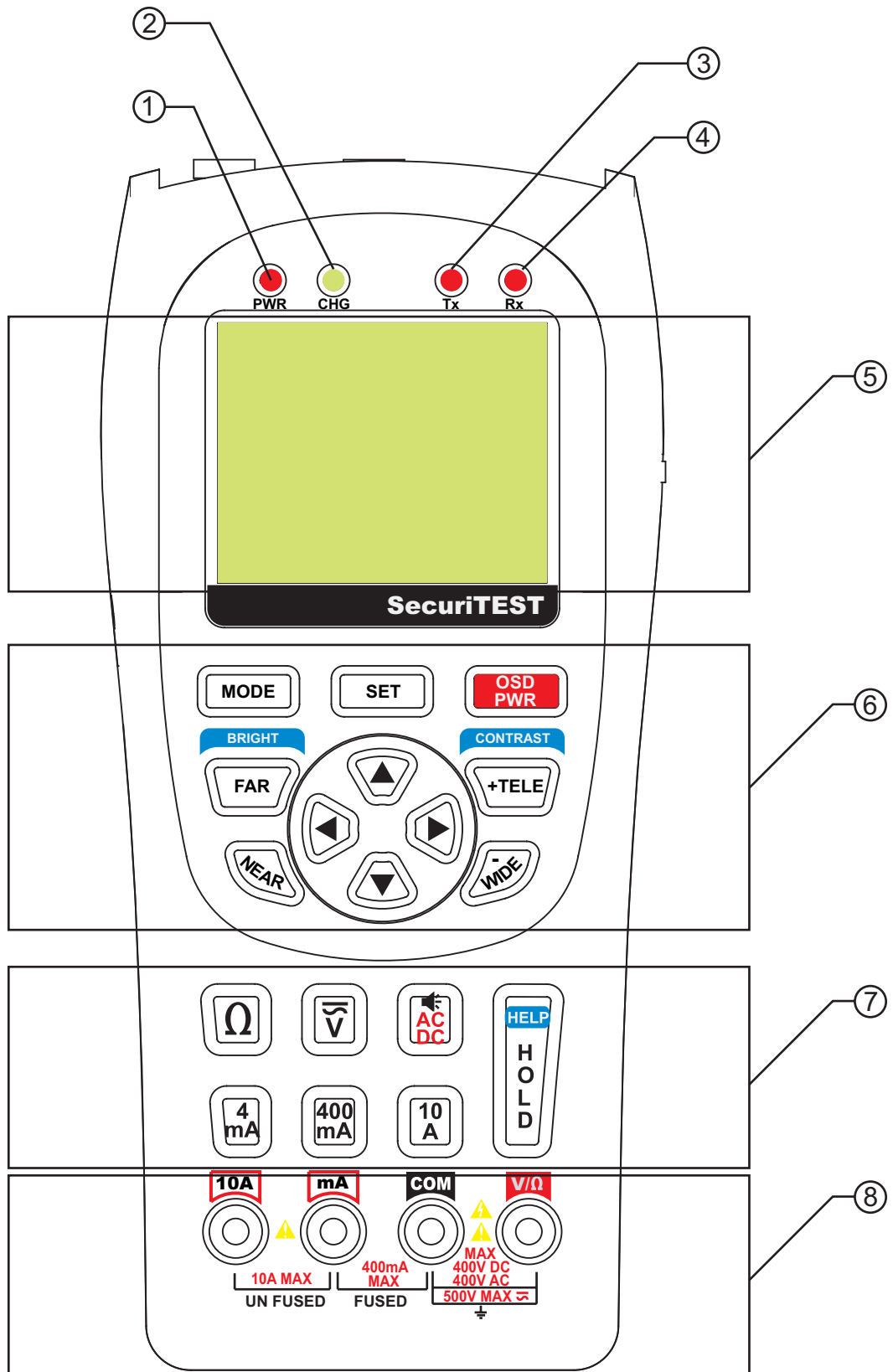



2. SecuriTEST Introduction











Names & Functions



Part	Name	Function
①	Power LED	Red LED is on when the system is switched on
②	Charge Indicating LED	Green LED is on when being charged
③	Data Transmitting LED	Red LED is on when PTZ data is transmitted
④	Data Receiving LED	Red LED is on when PTZ data is received
⑤	LCD	2.5" Color TFT LCD
⑥ Keypad		Controls cameras connected to SecuriTEST
	MODE Button	Mode Select (Video, Multi Meter, PTZ Control, UTP Test)
	SET Button	used when setup is changed, hold for special functions
	OSD Button	It toggles OSD & POWER on/off
	FAR Button	Adjusts PTZ focus (far direction) & Video Mode Brightness
	NEAR Button	Adjusts PTZ focus (near direction) & Video Mode Brightness
	TELE Button	Zooms PTZ (zoom in) & adjusts Video Mode Contrast
	WIDE Button	Zooms PTZ (zoom out) & adjusts Video Mode Contrast
	Direction Keys	Moves up, down, right, left for PTZ & for menus & others



2. SecuriTEST Introduction

Part	Name	Function
⑦ MultiMeter Keys		Selects functions of Digital MultiMeter
	Resistance Button	Selects resistance mode
	Voltage Button	Selects voltage mode
	Setup Change Button	Toggles AC/DC mode and selects continuity test
	Current Measuring Button 1	Selects low current (below 4 mA) mode
	Current Measuring Button 2	Selects current (below 400 mA) mode
	Current Measuring Button 3	Selects current (up to 10A) mode
	HOLD, HELP Button	Locks auto-ranging function. Hold for HELP
⑧ Test Lead Connection		Ports for Digital MultiMeter
		Voltage & Resistance Port
		Common Port
		Current measurement below 400mA Port
		Current measurement up to 10A Port

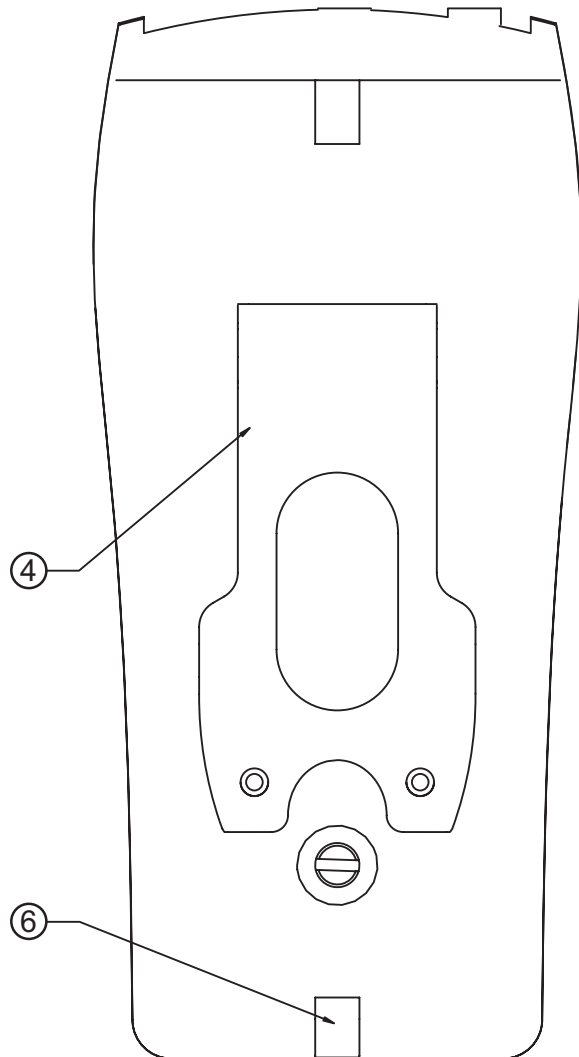
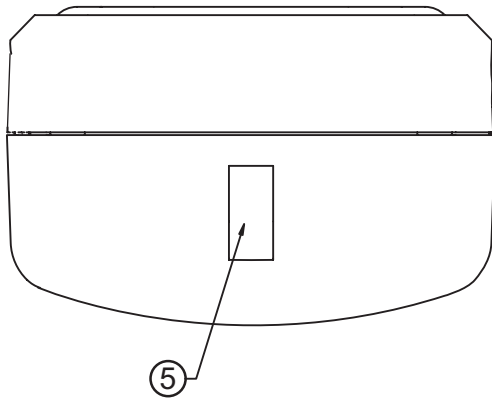
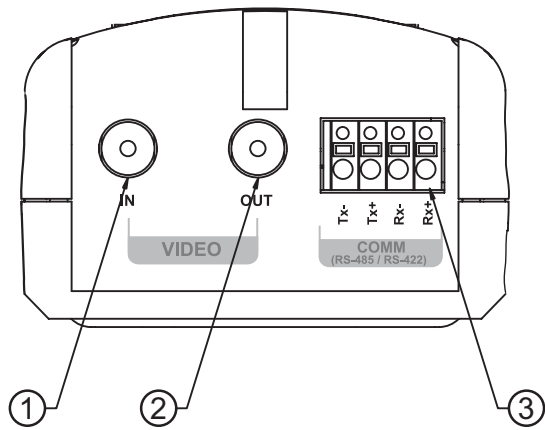

Part	Name	Function
①	Input BNC	Connect to camera output to display image on screen
②	Output BNC	Use as pass-through port for camera image or to output video test signal to external monitor
③	Communication Port	Input & output of communications signals
④	Kickstand	Holds unit upright when extended
⑤	Neckstrap Hook	Connect neckstrap here to hang unit
⑥	Neckstrap Hook	Can be used to hang the unit upside down



2. SecuriTEST Introduction

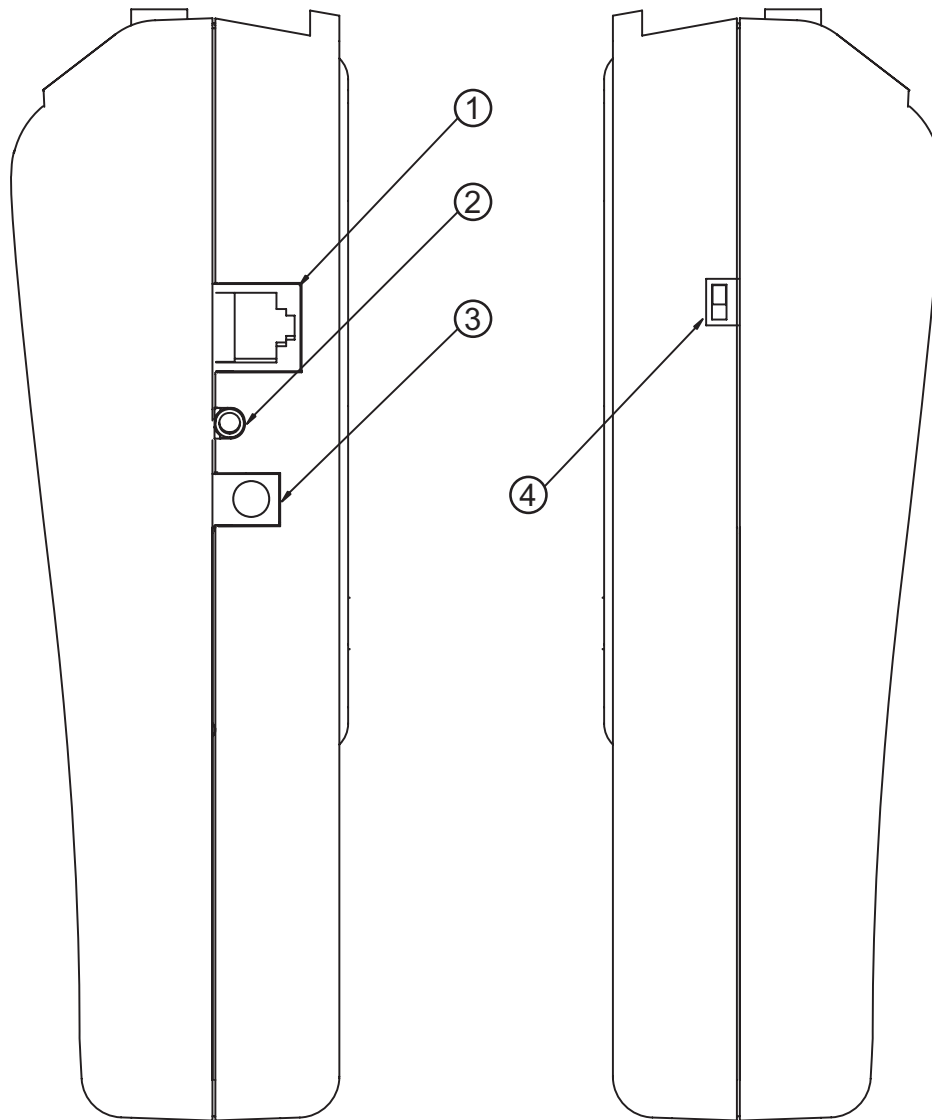

Part	Name	Function
①	UTP Jack	Test jack for UTP cable
②	AUX Jack	Audio, AUX input port (for future use)
③	DC Power Jack	DC power input jack(for over DC12V,1A)
④	Power S/W	Main power supply ON/OFF switch



3. SecuriTEST Specifications

• General Specifications

Electric Characteristics	Input Voltage	12V \pm 10%, above 1A	
	Battery	Rechargeable Ni-MH battery 6ea (AA size)	
	Built-in Charger	Charging Time	Above 8 hrs
		Operation time	>3 hrs
Image	TV Type	NTSC/PAL	
	Image level	1 Vpp, 140IRE	
PTZ operation test	Protocol	Multi-Protocol support	
	Transmission speed	2400bps ~ 38400bps	
	Transmission mode	RS-422,RS-485	
UTP Cable Test	Kinds of test	direct/cross cable, and broken or short-circuit	
Size	W 3.5" (88mm) X L 7.9" (190mm) X H 2.3" (58mm)		



3. SecuriTEST Specifications

○ Meter Specifications

Measuring Item	Measured Value		Minimum Measuring	Accuracy
DC Voltage	400mV		100uV	$\pm(0.8\% + 2\text{dgts})$
	4V		1mV	$\pm(1.0\% + 2\text{dgts})$
	4V		10mV	
	400V		100mV	
AC Voltage	4V		1mV	$\pm(1.2\% + 3\text{dgts})$ (40H Z ~ 500H Z)
	40V		10mV	
	400V		100mV	
DC Current	4mV	400uA	0.2uA	$\pm(1.0\% + 2\text{dgts})$
		4mA	2uA	
	400mV	40mA	20uA	$\pm(1.5\% + 2\text{dgts})$
		400mA	200uA	
	10A	10A	2mA	$\pm(2.0\% + 3\text{dgts})$

Measuring Item	Measured Value		Minimum Measuring	Accuracy
AC Current	4mV	400uA	0.2uV	± (1.5% + 5dgts) (40Hz ~ 500Hz) 40Hz ~ 500Hz
		4mA	2uV	
	400mV	40mA	20uV	± (1.8% + 5dgts) (40Hz ~ 500Hz) 40Hz ~ 500Hz
		400mA	200uV	
10A	10A	2mV	± (3.0% + 4dgts) 40Hz ~ 500Hz	
Resistance	400 Ω		0.1 Ω	± (1.0% + 4dgts)
	4kΩ		1 Ω	± (1.0% + 2dgts)
	40kΩ		10 Ω	
	400 kΩ		100 Ω	
	4MΩ		1kΩ	± (2.0% + 4dgts)
	40MΩ		10kΩ	± (3.0% + 5dgts)
Continuity	Beeper is activated when the resistance is below 80 Ω			
Rated fuse	250 Volt 800 mA			



4. Functional Use

● Power ON/OFF

The Power slide switch is located on the side of the handset.

Turn the Power slide switch on, and press  to start SecuriTEST.

To turn off the system, press  more than 3 sec. Then, POWER OFF is displayed on the main screen with a beep. Release the button.

The power goes off.

A rechargeable battery should be plugged in over 8 hrs to fully charge.

The charged battery can operate for about 3 hours.

When the battery indicator shows below , recharge it for use.

(Full charge : )

● OSD Setup Screen when Power is on

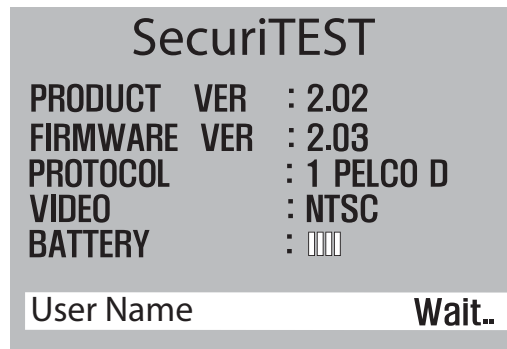

When power is on, the setup OSD is displayed, and it enters automatically to the video test mode after 3 ~ 5 sec.

The initial OSD displays its SecuriTEST version and the initial setup on the screen.

Product Version : 2.02

Firmware Version : 2.03

Initial Protocol : PELCO-D

TV mode : NTSC/PAL automatic setup

Battery indicator : 

User Name : User's name (Name can be changed in Main menu.)

Model & software versions are subject to be changed without notice.

● Mode Setup

Pressing the  key changes the operation mode between VIDEO, METER, PTZ and UTP.

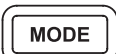
To directly select a mode, press and hold the  key for 3 seconds then choose a mode and press the  key to select the mode.

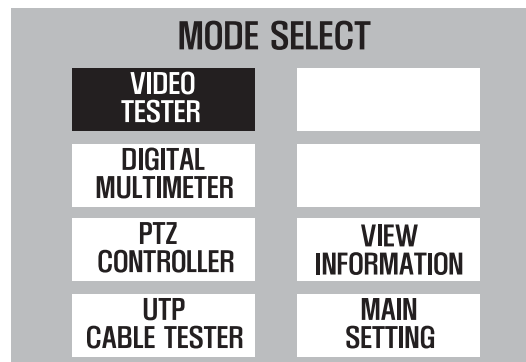

Video Tester Mode :

In this mode, the image quality of the external input picture signal is tested, or the monitor, etc. is tested by using the picture signal that is output from PATTERN GENERATOR mode.

Digital Multimeter mode :

In this mode, voltage, current, & continuity are tested.

PTZ Controller mode :

In this mode, the basic movement of up, down, right, left for PTZ cameras is controlled. Zooming and focus can also be adjusted.

UTP Cable Test mode :

UTP cables, are tested for straight (direct), crossover, opens, and shorts.



4. Functional Use

View Information mode :

In this mode, the basic information of SecuriTEST can be seen.
(version, battery level, communications protocol and speed.)

Main Setting mode :

At this mode, the basic setup of SecuriTEST can be changed.
(user's name, auto power off time, beeper, brightness, contrast, etc.)

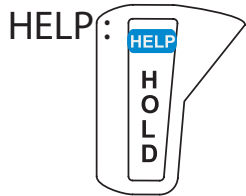

HELP: HELP image relevant to the mode displays when the key is pressed on for more than 2 seconds.
This function gives a brief explanation of the current function.

● VIDEO TEST

Connect the output of video output system to the video input BNC of SecuriTEST.

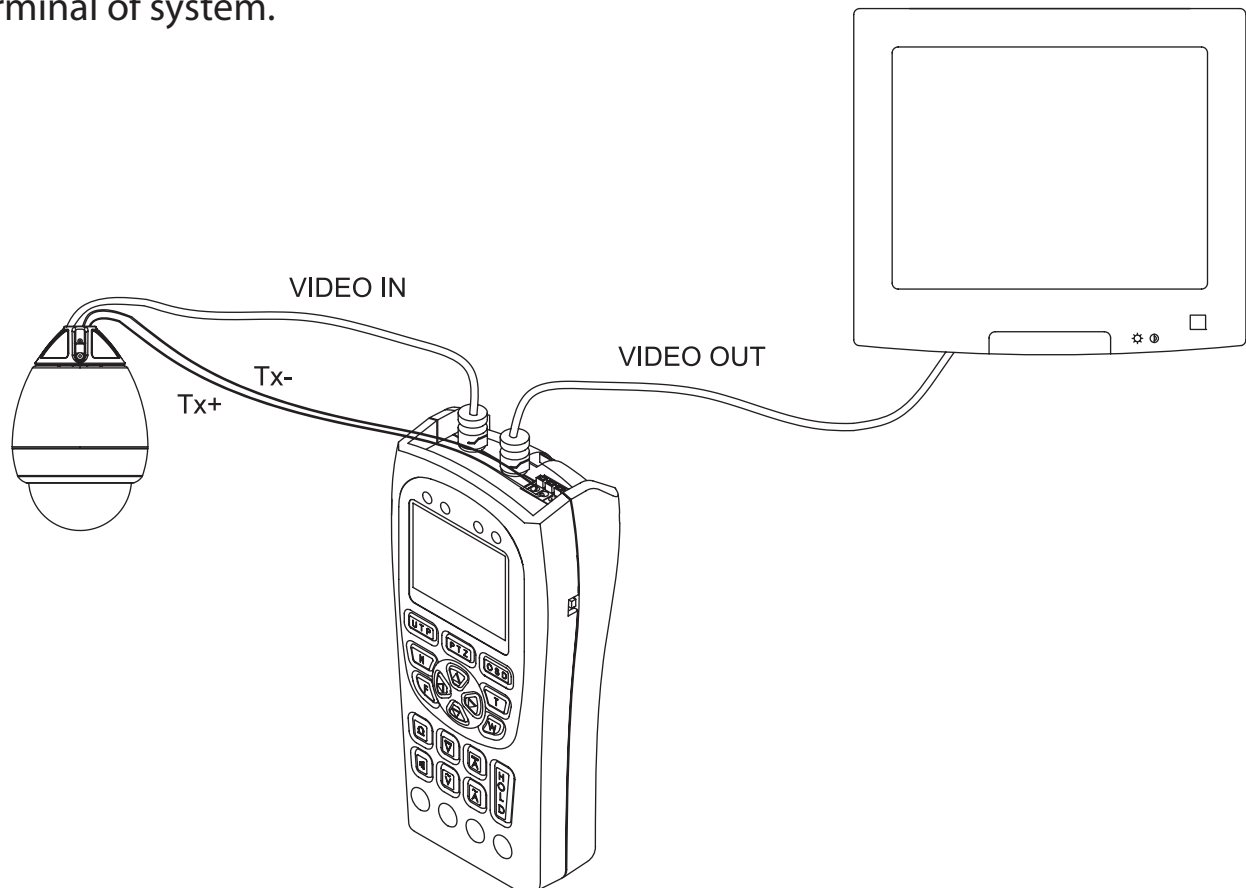

Connect the video output BNC of SecuriTEST to the video input terminal of system.



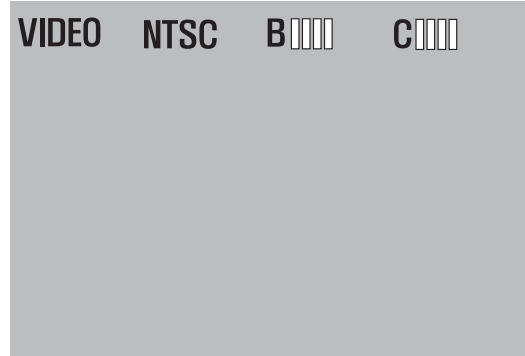



OSD Screen Setup



VIDEO : Indicates that the system is in video test mode.

NTSC : Indicates if input or output video signal system is NTSC or PAL. Input video signal is output on LCD screen automatically. Output video signal in Pattern Generator mode can be switched to NTSC or PAL, using  or  keys.

B [||||] : Indicates screen brightness, and the brightness increases gradually by +1 when  key is pressed, and decreases gradually by -1 when  key is pressed. Returns to the initial setup value when one of the two keys is pressed for more than 3 sec.

C [||||] : Indicates screen sharpness, and the brightness increases gradually by +1 when  key is pressed, and decreases gradually by -1 when  key is pressed. Returns to the initial setup value when one of the two keys is pressed for more than 3 sec.

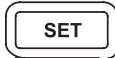

4. Functional Use

Enter the PATTERN GENERATION MODE when  key is pressed in VIDEO mode.

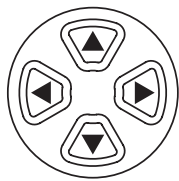

Output is changed between NTSC or PAL, using

 or  keys.

Output patterns can be cycled between COLOR BAR, RED, BLUE, GREEN

using  or  keys.

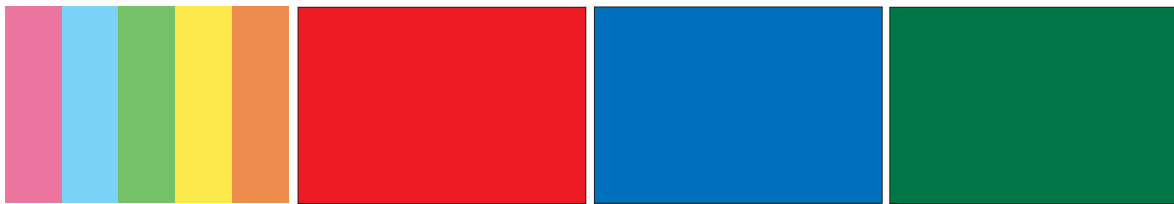

COLOR BAR

RED

BLUE

GREEN

Press  key to return to Video MODE.

○ DIGITAL MULTI METER

Voltage, current, resistance, continuity can be measured.

WARNING

To prevent an electric shock, injury or damage to SecuriTEST, turn off the power supply **o**f the circuit, and discharge all the high-voltage capacitors before testing resistance and continuity.

When using the meter function of your SecuriTEST, make sure to turn on its power and set **th**e proper mode before connecting the test leads to the circuit to be tested.

⚡ KEY SELECTIONS

Press  button, and then press  button to change to continuity mode

Press the  button, and then press  button to cycle between ACV/DCV.



This button is used to test current below 4mA.



This button is used to test current below 400mA.



This button is used to test current below 10A.



4. Functional Use

Description of METER MODE LCD WINDOW

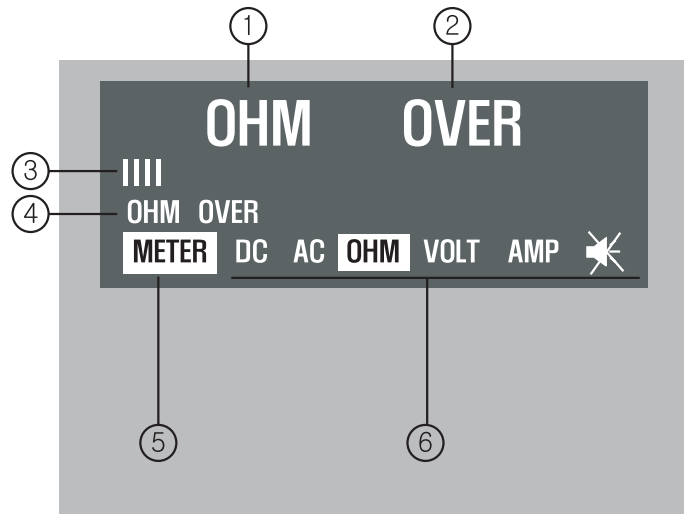



Part	Function	Description
①	Test Mode	<ul style="list-style-type: none"> - Resistance test - Continuity test - Set up tests of DC/AC voltage, current
②	Test value	<ul style="list-style-type: none"> - Ω unit of resistance test is indicated - Indicator of AC or DC value of voltage or current - AC voltage & current are indicated as rms (root mean square)
③	Measured value graph	<ul style="list-style-type: none"> - Input measured value is indicated in the form of graph Graph is changed automatically equal to the measured value in automatic mode OVER is displayed when higher value is measured than the setup value
④	Measured value in memory hold	The measured value is stored and indicated here when SET key is pressed during measurements.
⑤	MODE display	Digital Multi Meter Mode is displayed

Part	Function	Description
⑥	DC	DC Voltage test
	AC	AC Voltage test
	OHM	Resistance test (Measuring unit : Ω)
	VOLT	Voltage test (Measuring unit : V)
	AMP	Current test (Measuring unit : mA, A)
		Continuity test (Beeps below 80 Ω)

MEASURING RESISTANCE

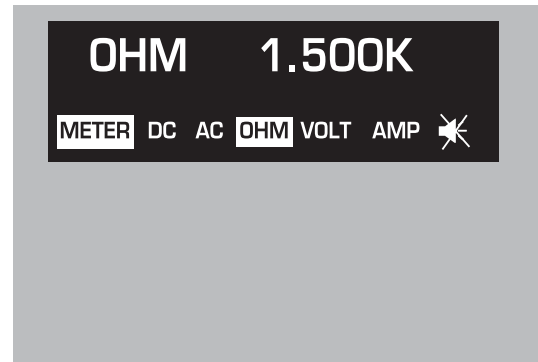
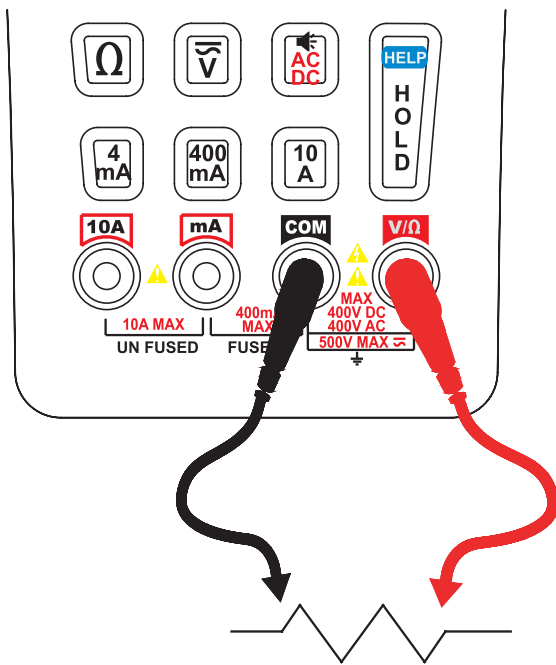
The unit of measurement is Ω . The meter sends low current into the circuit to measure its resistance.



How to measure : Connect the red lead to **V/Ω** and the black lead to **COM** as shown in the figure above at left. Measure in the resistance mode by pressing  on the key pad.



4. Functional Use

TESTING CONTINUITY

Continuity indicates the presence of a complete path for current flow.

The continuity test features a beeper that sounds when a circuit is complete.

The beep allows users to quickly test continuity without having to watch the display.

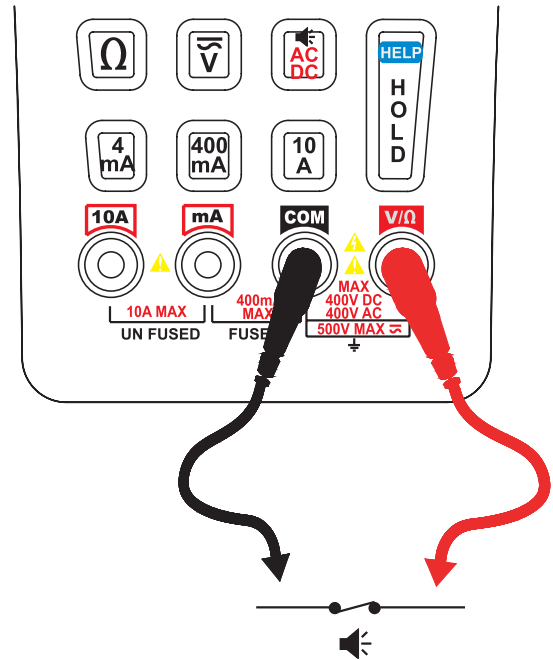
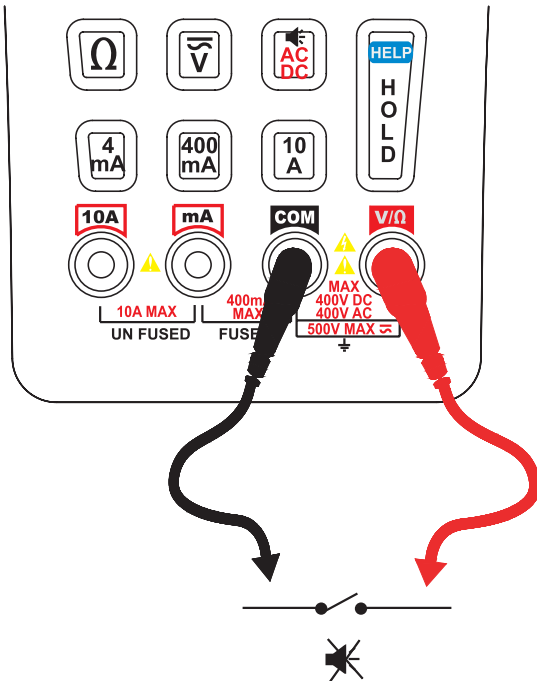
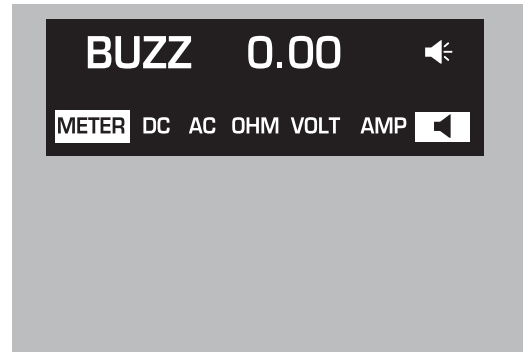
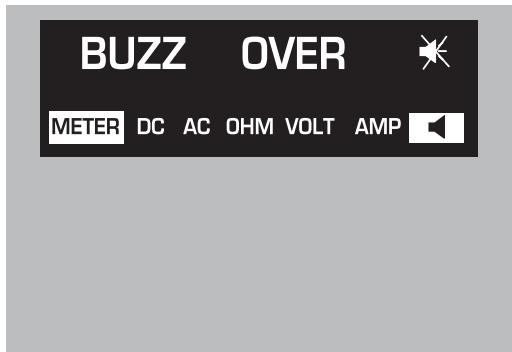



How to test : The resistance mode changes to the continuity mode, when  is pressed. The beeper is activated when the resistance between the red probe and black probe is below 80 Ω .

MEASURING AC & DC VOLTAGE

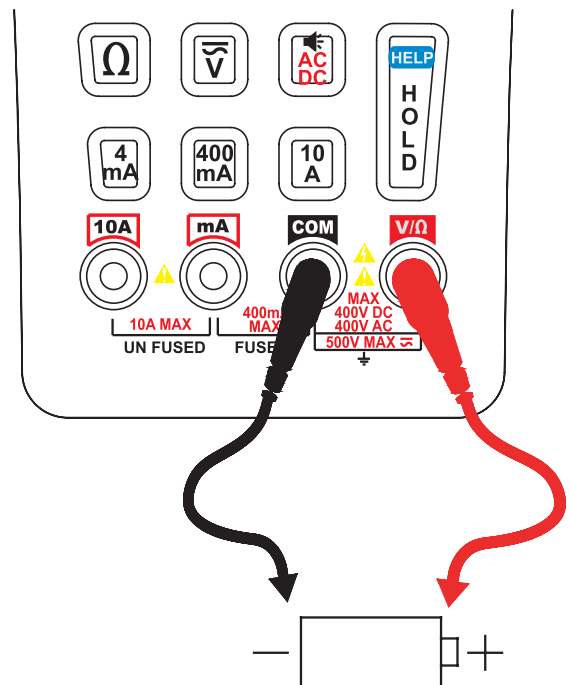
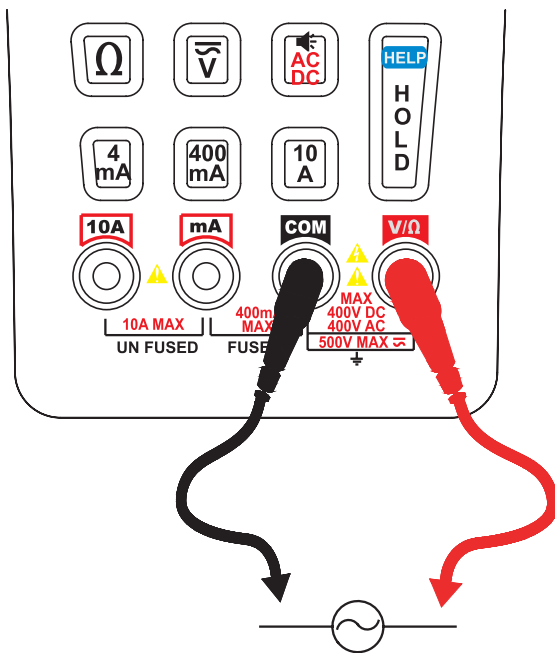
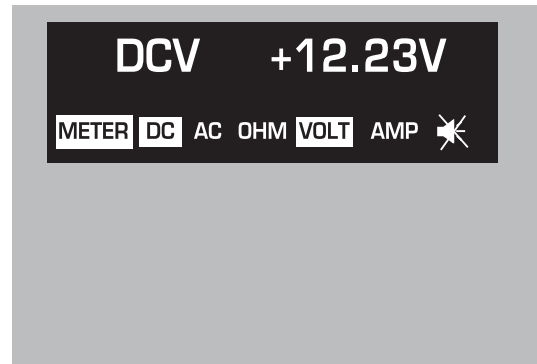
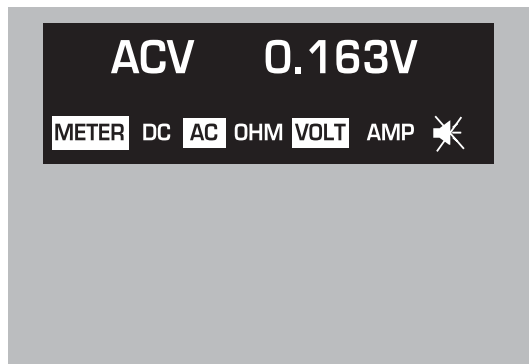
Voltage means the difference in electrical potential between two points. The polarity of AC voltage varies over time, while the polarity of DC is constant over time. The meter displays AC voltage values as rms (root mean square) readings. The rms value means the equivalent dc voltage that can produce the same amount of heat in a resistance as the measured sinewave voltage.



How to measure : First, press  , the voltage measuring button, then select AC or DC by pressing  . When measuring DC, place the red lead on the “+” point, and the black lead on “-” point of the circuit.







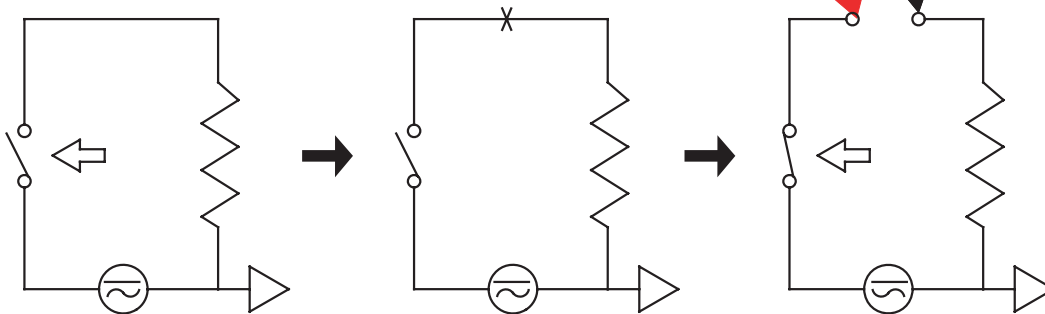
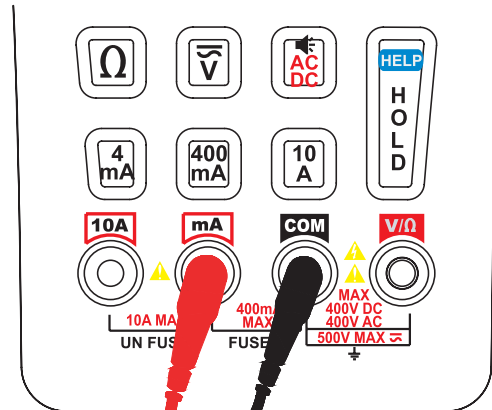
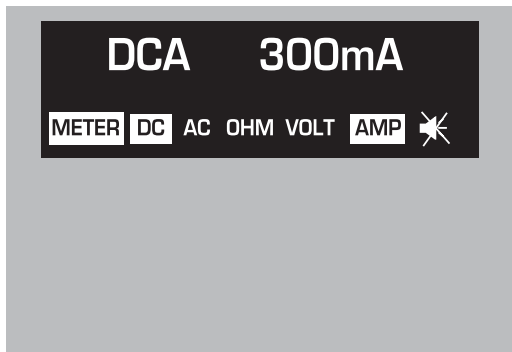

4. Functional Use

MEASURING AC & DC CURRENT

Current is simply defined as a flow of electrons running through a conductor. To measure current, you must break the circuit under test, and place the meter in series with the circuit. The current measuring range of the meter is 10A max.



How to measure : First, turn off the power to the circuit and discharge any high voltage capacitors. Place the red lead into the mA or 10A terminals in accordance with the value to be measured. Select one of the buttons

  or . When  &  are selected, place the red lead on mA. When  button is selected, place the red lead on 10A.



WARNING

Check the position of the test lead set in current test mode. Place the red lead at mA only when below 400mA, and place it at 10A when the value to be tested is over 400mA, or the value is unknown.



WARNING

Do not attempt to measure voltage when the test leads are connected to the mA or 10A port. Doing so will create a short circuit condition and blow the internal fuse or cause damage to the instrument and possibly cause bodily injury.



4. Functional Use

○ PTZ CONTROLLER

How to connect each terminal and LCD screen

PTZ Operation Test : Up, Down, Left, Right, Zoom and Manual focus control are possible. The tester can also be set to various protocols and transmission speeds (baud rates). To use the PTZ control connect the Tx port of SecuriTEST to the camera PTZ circuit. The Rx port of SecuriTEST can be connected to the output of a PTZ controller to analyze its output to determine the protocol in use. Press and hold the SET button to access the PTZ setup menu.

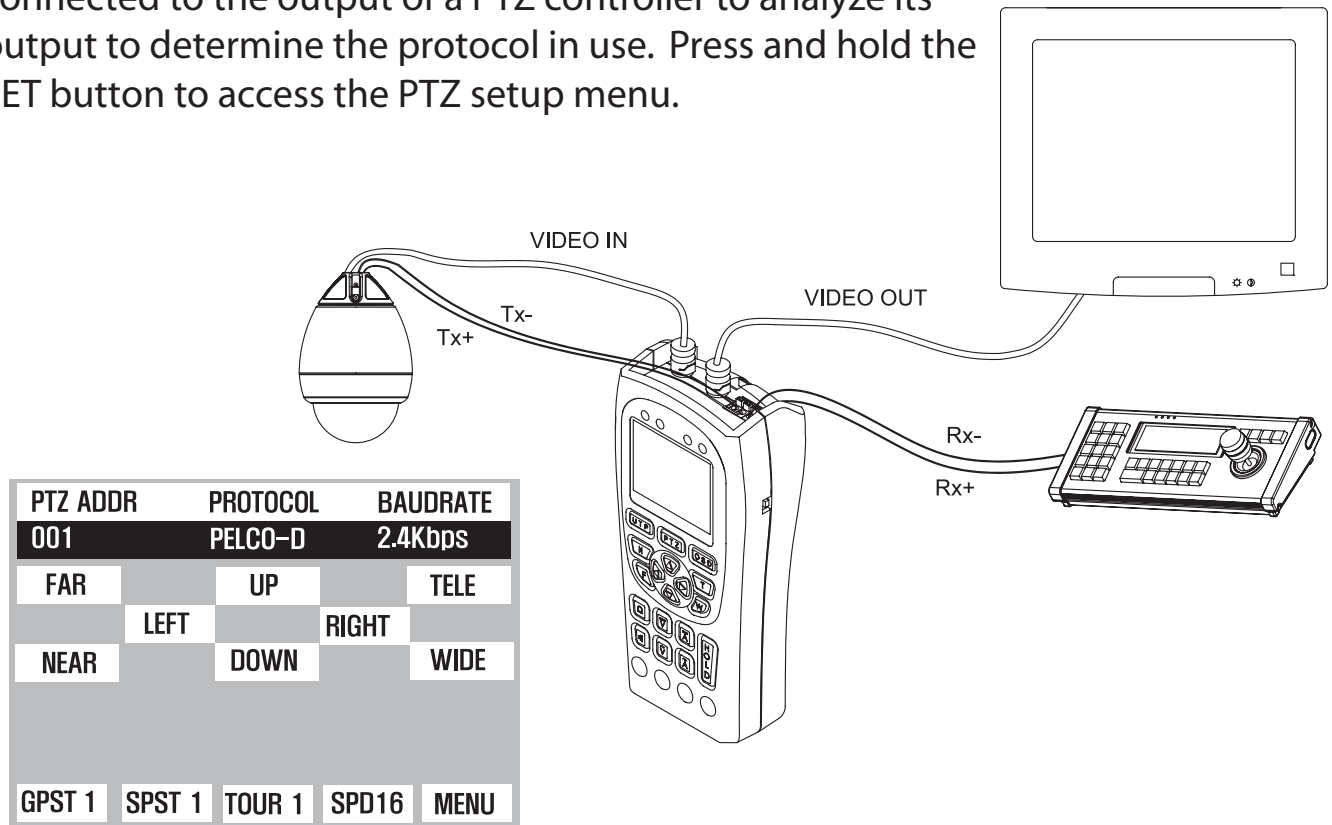

- PTZ Control Setup Screen

PTZ ADDR	PROTOCOL	BAUDRATE
001	PELCO-D	2.4Kbps
GPST 1	SPST 1	TOUR 1
SPD16	MENU	

ADD Setup Screen

PTZ ADDR	PROTOCOL	BAUDRATE
001	PELCO-D	2.4Kbps
	PELCO-P	
	WONWOO	
	SPD-2500	
	SCC-643	
	SJ-100	
	SJ-1000	
GPST 1	SPST 1	TOUR 1
SPD16	MENU	

Protocol Setup Screen

PTZ ADDR	PROTOCOL	BAUDRATE
001	PELCO-D	2.4Kbps
		4.8Kbps
		9.6Kbps
		19.2Kbps
		38.4Kbps
GPST 1	SPST 1	TOUR 1
SPD16	MENU	

Communications Speed Setup Screen

- Key Board Control Code Screen

PTZ ADDR		PROTOCOL		BAUDRATE	
001		PELCO-D		2.4Kbps	
FAR		UP		TELE	
	LEFT		RIGHT		
NEAR		DOWN		WIDE	
FF 01	08 04	3F 3F	8B		
FF 01	08 04	3F 3F	8B		
FF 01	08 04	3F 3F	8B		
FF 01	08 00	00 00	09		
GPST 1	SPST 1	TOUR 1	SPD16	MENU	

- The control commands from the keyboard of an external control are displayed on the screen. Most important is that the communications speed be matched.

When you want to know the input signal of an exterior controller, you can see the input data by connecting the communications cable to the RX terminal of the SecuriTEST.

Using the PTZ Controls

PT control (Up, Down, Left, Right), is performed using the arrow keys. Zoom is controlled using the TELE/WIDE buttons, and focus is controlled with the FAR/NEAR buttons.

FUNCTION SETUP of PTZ



Press the SHIFT key then use the arrow keys to adjust GPST / SPST / TOUR / and SPD functions.

SPD / MENU are displayed on the lower part of LCD screen by pressing the SET key once shortly.

GPST : Moves the camera view to the designated preset location.

Setup can be from 1 up to 99. (short for GO TO PRESET).



The cursor goes to the GPST position after the  key is pressed, select the previously memorized PRESET number using the arrow keys.



When the selection is complete, press  again to move the camera.



4. Functional Use

SPST: Memorizes PRESET. Setup can range from 1 up to 99. (short for SET PRESET).

First, move the camera to the desired view and press the  key, then using the  &  keys, select SPST and set the address

to store using the  &  keys. Press the  key once more to save the address.



TOUR: Operates TOUR through SPST points. Can be programmed from 1 to 99. TOUR is set using the same process described for the SPST function.

SPD : Sets the speed of the camera. Programed using the same described for SPST. Range is from 1 to 16.

CAUTION

Make sure to check communications protocol, transmission speed, and ID.

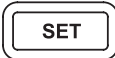
PTZ CONTROL SETUP

PTZ ADDR is activated on the upper part on LCD screen, when  key is held for more than 3 seconds. The menu also controls the PTZ Protocol and Baud rate. Use the  &  keys to move between the menus.

PTZ ADDR : Setup of PTZ Camera Address.

Each PTZ camera in a system must have a unique address from 1 to 255 to allow it to be operated by a PTZ controller. Use the PTZ ADDR function to set the address of the camera to control.

PTZ ADDR	PROTOCOL	BAUDRATE
001	PELCO-D	2.4Kbps

PROTOCOL : Setup of PTZ PROTOCOL

Camera manufacturers use various communications protocols to control the PTZ functions of the camera. Use the PROTOCOL menu to set the output of SecuriTEST to match the protocol of the camera system in use.

PTZ ADDR	PROTOCOL	BAUDRATE
001	PELCO-D PELCO-P WONWOO	2.4Kbps



4. Functional Use

* BAUDRATE : Setup of TRANSMISSION SPEED

The initial setup is 2.4kbps, it can be set from 2.4kbps to 38.4kbps.

PTZ ADDR	PROTOCOL	BAUDRATE
001	PELCO-D	2.4Kbps 4.8Kbps 9.6Kbps 19.2Kbps 38.4Kbps

To escape from the PTZ CONTROL SETUP mode, simply, press the  key again.



CAUTION

Make sure to check for CAMERA ID, PROTOCOL, BAUDRATE when the testing. PTZ operation test can not be done when the setup is different from the camera.

⦿ UTP CABLE TESTER

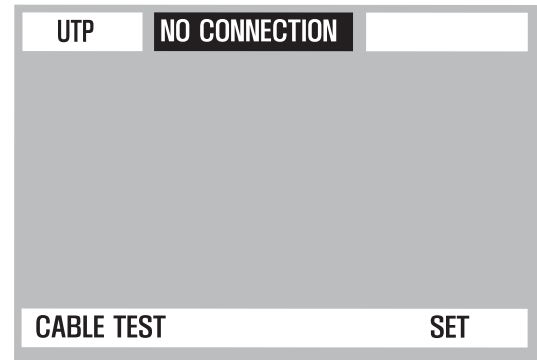
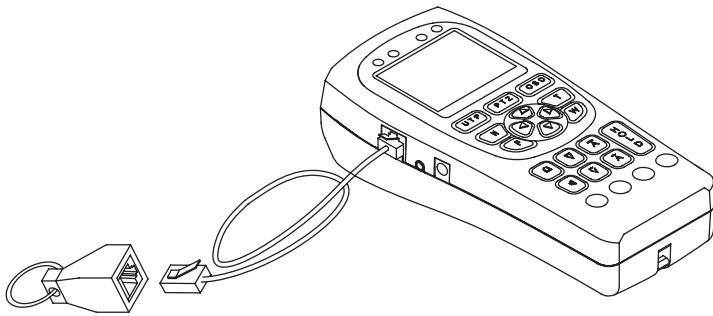

Connect one end of the UTP cable to be tested to the UTP Cable Test port of SecuriTEST and the other end to the yellow UTP cable terminator.

The connected condition of the cable can be tested, by pressing

The test can detect straight and crossover cables as well as shorts, opens and most miswire conditions.

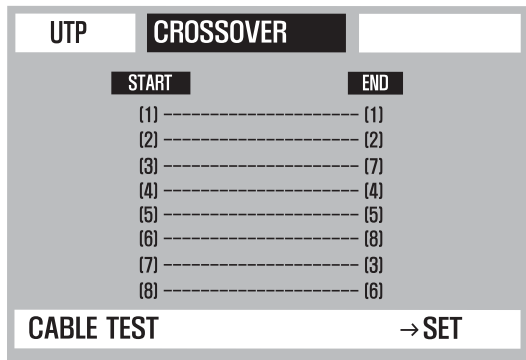

Cross cable

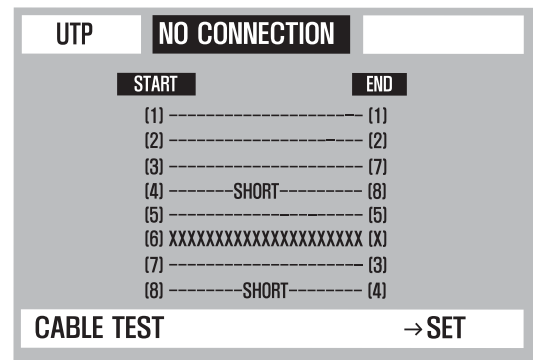

Short-circuit & Disconnection

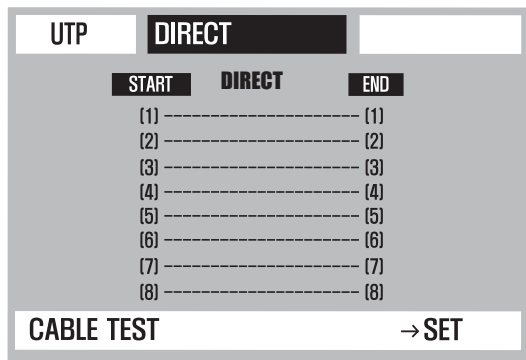



Direct cable



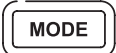

4. Functional Use

● VIEW INFORMATION

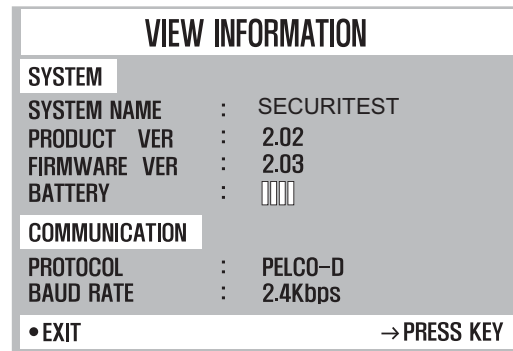
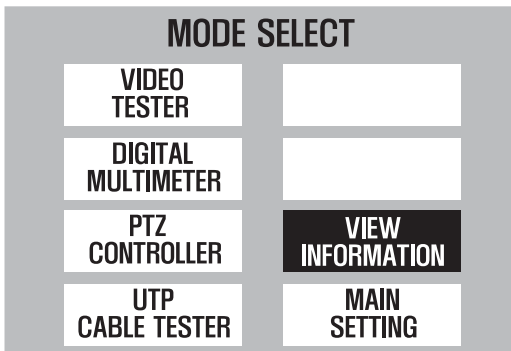
Mode Setup : First, press  key more than 3 sec. and select VIEW INFORMATION on MODE SELECT MENU, then press  key.

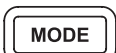

● MAIN SETTING

Mode Setup : First, press  key more than 3 sec. and select MAIN SETTING on MODE SELECT MENU, then press  key.

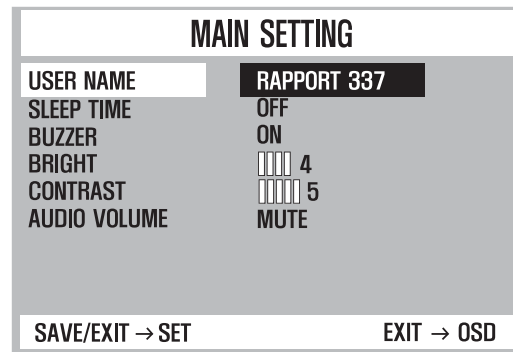
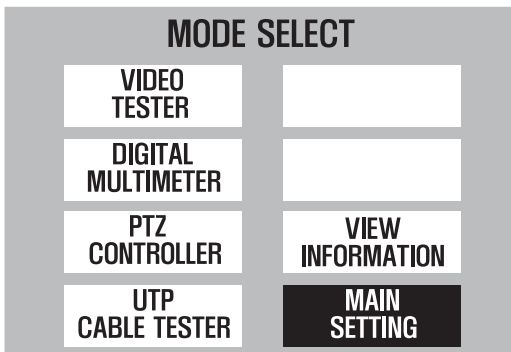

Select the item by pressing  &  keys. The each setup value can be changed by pressing  &  keys.

A user can enter the name he or she wants by editing USER NAME. SLEEP TIME sets the time that SecuriTEST will remain on when no button presses are detected.