



SAFETY HiTESTER 3258

Safe Voltage Measurement in Breaker Cubicles

■ New Technology

Measure voltage on insulated electric cables

■ Safety

Measure safely around metal busbars and terminals

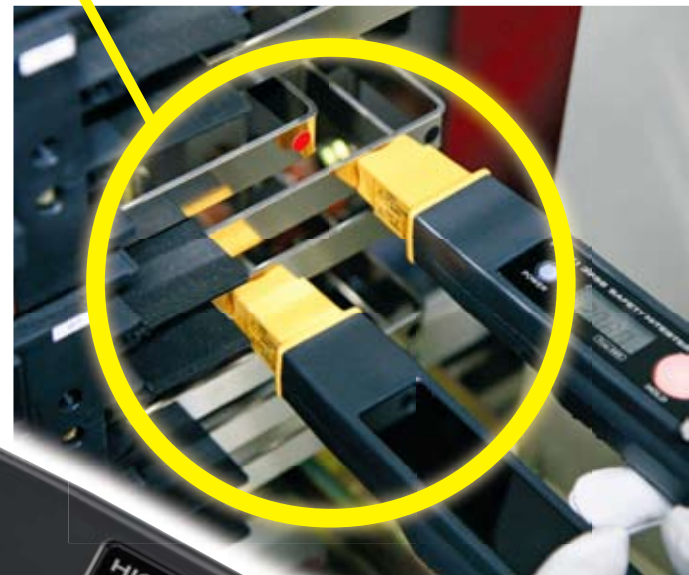

■ Applicability

Optimized for 380-480 V AC lines

Measurable electrical cable: 38 mm² or larger insulated wires (100 mm² or larger recommended)

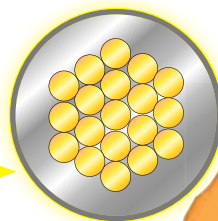

ISO 9001
JMI-0216



ISO 14001
JQA-E-90091



CAT IV 600V

True RMS

HIOKI's **new technology** enhances voltage measurement safety

Development of the SAFETY HiTESTER 3258 opens the door to a new realm of safety by accurately measuring non-destructively through wire insulation, a particular safety concern to those who maintain and inspect electrical facilities

Safe Probe Heads



Reliably safe, non-metallic resin heads

True RMS values on large, crystal-clear display

Data Hold Indicator
Shows when data is being held (HOLD button pressed)

AC Indicator
~

Low Battery Indicator
E

Measured Value
True RMS values retain accuracy despite waveform distortion

APS Indicator (Auto Power Shutoff)
The HiTESTER automatically shuts off when 10 minutes have elapsed from the last operation (can be disabled)

Voltage Unit Indicator
V

Voltage Detector

Power Button



Safety Barrier

Applicable electric cable types

Size: 38 mm² or larger insulated electric line (100 mm² or larger recommended)

Actual-size cross sections

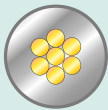

38 mm² (11.5 mm dia.) insulated cable

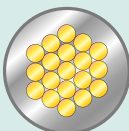

100 mm² (17 mm dia.) insulated cable

Easy operation and informative display

- Hot line check**
The HOLD lamp flashes when an energized line (at least 30 V AC) is detected.

Hot Line Indicator



- Measured value**
When the display has stabilized, the HOLD lamp lights and the measured value is displayed.

Measured Value



- Hold measured value**
Press the HOLD button to temporarily freeze the displayed value. Lamp turns off

Measurement Hold

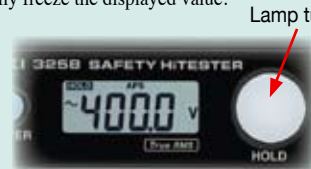

Ensures safe measurements in the cubicle

Point 1

Easily measure right through cable insulation



Point 2

Safely measure around busbars



Also safe for metallic conductors



Actual size

Long grip for better safety
Safely measure 380-480 V AC lines

Get accurate measurements easily

The HiTESTER measures the voltage between two probes. To ensure accurate measurements, apply the voltage detector probes perpendicular to the object to be measured.
To measure voltage to ground, apply one probe to a ground conductor.

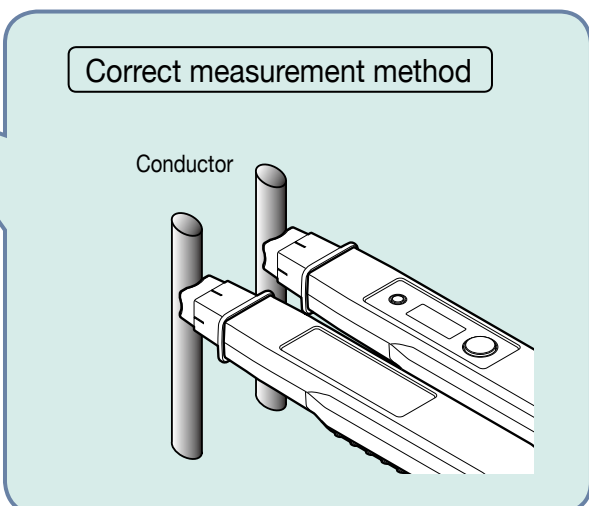
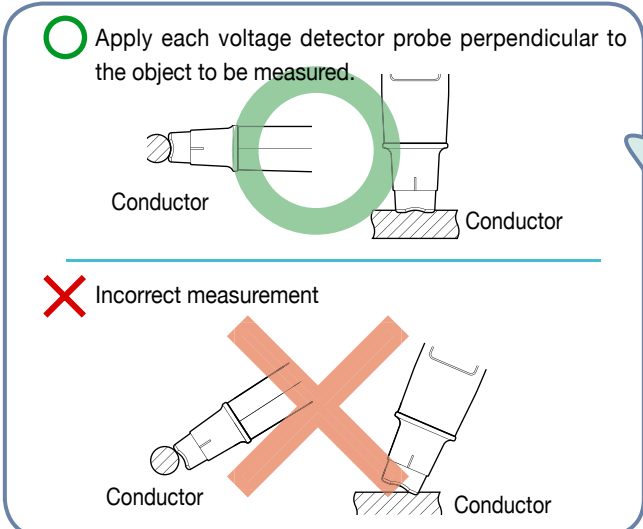

HiTESTER 3258 measurement principle

Measurements with traditional non-metallic-contact voltmeters and phase detectors depend on the coupling capacitance (C_1 and C_2) between voltage detector electrodes in the probe tips and the measurement objects. That voltage detection method can present problems due to the dependence of the coupling capacitance on the material properties of the measurement objects, making accurate voltage determination ($V_m = V_{m2} - V_{m1}$) problematic.

The SAFETY HiTESTER 3258 employs a new technological principle to detect accurate measurement voltage (V_m) independent of coupling capacitance.

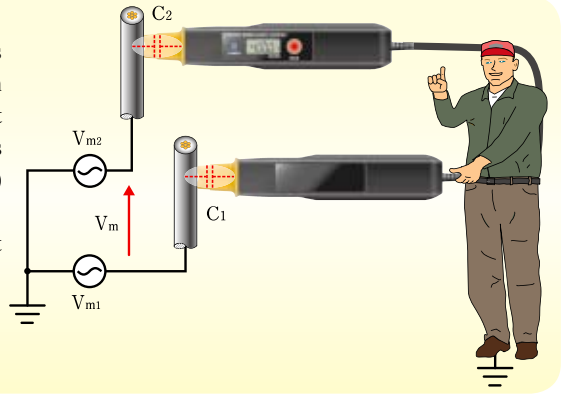

Model 3258 Specifications (accuracy guaranteed for one year at 23 ±5°C and 80% RH or less)

Measurement parameter	AC voltage (AC potential bridge)
Measurement objects	Insulated electric lines (Indoor PVC or equivalent, 100 mm ² or larger), metal conductors Note: Not suitable for shielded cables
Measurement values	True RMS display
Max. rated voltage to earth	600 Vrms AC
Circuit dynamics	Crest factor 1.8 (sine wave only at 600 V range)
Temp. characteristics	0.05% rdg./°C
Effect of conductor diameter	0.5% rdg. (add to measurement accuracy for 38 to 100 mm ² insulated cables)
Effect of nearby conductors	±5% rdg. or less
Effect of external magnetic field	none
Display	4200 counts, with less than 10 counts zero-suppressed
Display refresh rate	Approx. once every 0.6 seconds
Display response time	2.4 s or less
Functions	Data Hold, Auto Power Shutoff, Low-Battery Warning
Operating temp. & humidity	0 to 40°C, 80% RH or less, non-condensating
Storage temp. & humidity	-10 to 50°C, 80% RH or less, non-condensating
Operating environment	Indoors, up to 2000 m ASL
Applicable standards	Safety: EN61010, EMC: EN61326
Power source	Six AA (LR6) alkaline batteries Max. operating time: approx. 14 h (power on, no input), or the equivalent of 1000 one-minute operations or 200 five-minute operations
Max. rated power	2 VA
Size and weight	51W(2.01") × 275H(10.83") × 37.5D(1.48") mm (per probe), Cable length: 900 mm (35.43"), 670 g (23.6 oz.) (including batteries)



● 600 V Range
Battery voltage error characteristics

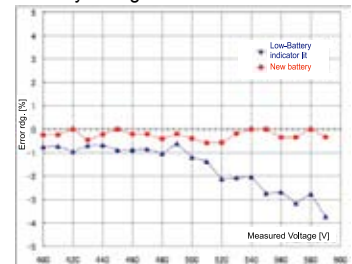

* Accuracy not guaranteed when the B indicator is ON.



Supplied Accessory: soft case

AC Voltage Measurement Accuracy (on insulated PVC cables or equivalent, 100 mm² or larger)

Ranges (auto-ranging)	Displayable range	Display resolution	Range of guaranteed accuracy	Accuracy	
				40 to 66 Hz	66 to 400 Hz
420.0 V	0.0 to 420.0 V	0.1 V	30.0 to 420.0 V	±1.5% rdg. ±5 dgt.	±2.5% rdg. ±5 dgt.
600 V	380 to 600 V	1 V	380 to 480 V	±2.0% rdg. ±5 dgt.	
			481 to 600 V	±5.0% rdg. ±5 dgt.	

SAFETY HiTESTER 3258

Supplied Accessories: One manual, one soft case and six AA (LR6) batteries



99 Washington Street
Melrose, MA 02176
Phone 781-665-1400
Toll Free 1-800-517-8431

▶ Visit us at www.TestEquipmentDepot.com

▶ Back to the Hioki 3258 Product Info Page