

# 100 MHz CombiScope® HM1008-2

Manual

English





Hersteller  
Manufacturer  
Fabricant

HAMEG Instruments GmbH  
Industriestraße 6  
D-63533 Mainhausen

KONFORMITÄTSERKLÄRUNG  
DECLARATION OF CONFORMITY  
DECLARATION DE CONFORMITE



Die HAMEG Instruments GmbH bescheinigt die Konformität für das Produkt  
The HAMEG Instruments GmbH herewith declares conformity of the product  
HAMEG Instruments GmbH déclare la conformité du produit

Bezeichnung / Product name / Designation:

Oszilloskop  
Oscilloscope  
Oscilloscope

Typ / Type / Type:

HM1008-2

mit / with / avec:

-

Optionen / Options / Options:

-

mit den folgenden Bestimmungen / with applicable regulations / avec les directives suivantes

EMV Richtlinie 89/336/EWG ergänzt durch 91/263/EWG, 92/31/EWG  
EMC Directive 89/336/EEC amended by 91/263/EWG, 92/31/EEC  
Directive EMC 89/336/CEE amendée par 91/263/EWG, 92/31/CEE

Niederspannungsrichtlinie 73/23/EWG ergänzt durch 93/68/EWG  
Low-Voltage Equipment Directive 73/23/EEC amended by 93/68/EEC  
Directive des équipements basse tension 73/23/CEE amendée par 93/68/CEE

Angewendete harmonisierte Normen / Harmonized standards applied / Normes harmonisées utilisées:

Sicherheit / Safety / Sécurité: EN 61010-1:2001 (IEC 61010-1:2001)  
Überspannungskategorie / Overvoltage category / Catégorie de surtension: II  
Verschmutzungsgrad / Degree of pollution / Degré de pollution: 2

Elektromagnetische Verträglichkeit / Electromagnetic compatibility /  
Compatibilité électromagnétique

EN 61326-1/A1 Störaussendung / Radiation / Emission:  
Tabelle / table / tableau 4; Klasse / Class / Classe B.

Störfestigkeit / Immunity / Imunité: Tabelle / table / tableau A1.

EN 61000-3-2/A14 Oberschwingungsströme / Harmonic current emissions /  
Émissions de courant harmonique:  
Klasse / Class / Classe D.

EN 61000-3-3 Spannungsschwankungen u. Flicker / Voltage fluctuations and flicker /  
Fluctuations de tension et du flicker.

Datum /Date /Date  
01. 06. 2007

Unterschrift / Signature / Signatur

Holger Asmussen  
Manager

## General information regarding the CE marking

HAMEG instruments fulfill the regulations of the EMC directive. The conformity test made by HAMEG is based on the actual generic- and product standards. In cases where different limit values are applicable, HAMEG applies the severer standard. For emission the limits for residential, commercial and light industry are applied. Regarding the immunity (susceptibility) the limits for industrial environment have been used.

The measuring- and data lines of the instrument have much influence on emission and immunity and therefore on meeting the acceptance limits. For different applications the lines and/or cables used may be different. For measurement operation the following hints and conditions regarding emission and immunity should be observed:

### 1. Data cables

For the connection between instrument interfaces and external devices, (computer, printer etc.) sufficiently screened cables must be used. Without a special instruction in the manual for a reduced cable length, the maximum cable length of a dataline must be less than 3 meters and not be used outside buildings. If an interface has several connectors only one connector must have a connection to a cable.

Basically interconnections must have a double screening. For IEEE-bus purposes the double screened cables HZ73 and HZ72L from HAMEG are suitable.

### 2. Signal cables

Basically test leads for signal interconnection between test point and instrument should be as short as possible. Without instruction in the manual for a shorter length, signal lines must be less than 3 meters and not be used outside buildings.

Signal lines must be screened (coaxial cable - RG58/U). A proper ground connection is required. In combination with signal generators double screened cables (RG223/U, RG214/U) must be used.

### 3. Influence on measuring instruments

Under the presence of strong high frequency electric or magnetic fields, even with careful setup of the measuring equipment, influence of such signals is unavoidable.

This will not cause damage or put the instrument out of operation. Small deviations of the measuring value (reading) exceeding the instruments specifications may result from such conditions in individual cases.

## 4. RF immunity of oscilloscopes.

### 4.1 Electromagnetic RF field

The influence of electric and magnetic RF fields may become visible (e.g. RF superimposed), if the field intensity is high. In most cases the coupling into the oscilloscope takes place via the device under test, mains/line supply, test leads, control cables and/or radiation. The device under test as well as the oscilloscope may be effected by such fields.

Although the interior of the oscilloscope is screened by the cabinet, direct radiation can occur via the CRT gap. As the bandwidth of each amplifier stage is higher than the total -3dB bandwidth of the oscilloscope, the influence of RF fields of even higher frequencies may be noticeable.

### 4.2 Electrical fast transients / electrostatic discharge

Electrical fast transient signals (burst) may be coupled into the oscilloscope directly via the mains/line supply, or indirectly via test leads and/or control cables. Due to the high trigger and input sensitivity of the oscilloscopes, such normally high signals may effect the trigger unit and/or may become visible on the CRT, which is unavoidable. These effects can also be caused by direct or indirect electrostatic discharge.

HAMEG Instruments GmbH

<b>General information regarding the CE marking</b>	<b>2</b>	<b>AUTOSET</b>	<b>19</b>
<b>100 MHz CombiScope® HM1008-2</b>	<b>4</b>	<b>Component tester</b>	<b>19</b>
<b>Specifications</b>	<b>5</b>	<b>CombiScope</b>	<b>21</b>
<b>Important hints</b>	<b>6</b>	Digital operation	22
List of symbols used:	6	Digital operating modes	22
Positioning the instrument	6	Memory resolution	22
Safety	6	Memory depth	23
Proper operation	7	Horizontal resolution with X magnifier	23
CAT I	7	Maximum signal frequency in DSO mode	23
Environmental conditions	7	Display of aliases	23
Warranty and repair	7	Vertical amplifier operating modes	23
Maintenance	7	<b>Data transfer</b>	<b>23</b>
Line voltage	7	<b>General information concerning MENU</b>	<b>25</b>
<b>Front Panel Elements – Brief Description</b>	<b>8</b>	<b>Controls and Readout</b>	<b>26</b>
<b>Basic signal measurement</b>	<b>10</b>		
Signals which can be measured	10		
Amplitude of signals	10		
Values of a sine wave signal	10		
DC and ac components of an input signal	11		
Timing relationships	11		
Connection of signals	11		
<b>First time operation and initial adjustments</b>	<b>12</b>		
Trace rotation TR	12		
Probe adjustment and use	12		
1 kHz adjustment	12		
1 MHz adjustment	13		
<b>Operating modes of the vertical amplifier</b>	<b>13</b>		
XY operation	14		
Phase measurements with Lissajous figures	14		
Measurement of phase differences in dual channel Yt mode	14		
Measurement of amplitude modulation	15		
<b>Triggering and time base</b>	<b>15</b>		
Automatic peak triggering (MODE menu)	15		
Normal trigger mode (See menu MODE)	16		
Slope selection (Menu FILTER)	16		
Trigger coupling (Menu: FILTER)	16		
Video (tv triggering)	16		
Frame sync pulse triggering	16		
Line sync pulse triggering	17		
LINE trigger	17		
Alternate trigger	17		
External triggering	17		
Indication of triggered operation (TRIG'D LED)	17		
Hold-off time adjustment	17		
Time base B (2nd time base). Delaying, Delayed Sweep. Analog mode.	18		
Alternate sweep	18		



**100 MHz CombiScope® HM1008-2**  
Valid at 23 °C after a 30 minute warm-up period

**Vertical Deflection**

<b>Channels:</b>	
Analog:	2
Digital:	2
<b>Operating Modes:</b>	
Analog:	CH 1 or CH 2 separate, DUAL (CH 1 and CH 2 alternate or chopped), Addition
Digital:	Analog Signal Channels CH 1 or CH 2 separate, DUAL (CH 1 and CH 2), Addition
X in XY-Mode:	CH 1
Invert:	CH 1, CH 2
Bandwidth [-3 dB]:	2 x 0 - 100 MHz
Rise time:	< 3.5 ns
Overshoot:	max. 1 %
Bandwidth limiting (selectable):	about 20 MHz (5 mV/cm - 20V/cm)
Deflection Coefficients(CH 1,2):	14 calibrated steps
1 mV - 2 mV/cm (10 MHz)	± 5% (0 - 10 MHz [-3 dB])
5 mV - 20 V/cm	± 3% (1-2-5 sequence)
variable (uncalibrated):	> 2.5:1 to > 50V/cm
<b>Inputs CH 1, 2:</b>	
Input Impedance:	1 MΩ    15 pF
Coupling:	DC, AC, GND (ground)
Max. Input Voltage:	400V (DC + peak AC)
Y Delay Line (analog):	70 ns
Measuring Circuits:	Measuring Category I
<b>Analog mode only:</b>	
Auxiliary input:	AUX: 100V (DC + peak AC)
Function (selectable):	Extern Trigger, Z (unblank)
Coupling:	AC, DC
Max. input voltage:	100V (DC +peak AC)

**Triggering**

<b>Analog and Digital Mode</b>	
<b>Automatic (Peak to Peak):</b>	
Min. signal height:	5 mm
Frequency range:	10 Hz - 200 MHz
Level control range:	from Peak- to Peak+
<b>Normal (without peak):</b>	
Min. signal height:	5 mm
Frequency range:	0 - 200 MHz
Level control range:	-10 cm to +10 cm
<b>Operating modes:</b> Slope/Video	
Slope:	positive, negative, both
Sources:	CH 1, CH 2, alt. CH 1/2 (≥ 8 mm, analog mode only), Line, Ext.
<b>Coupling:</b>	
AC:	10 Hz-200 MHz
DC:	0-200 MHz
HF:	30 kHz-200 MHz
LF:	0-5 kHz
	Noise Rej. switchable
<b>Video:</b> pos./neg. Sync. Impulse	
Standards:	525 Line/60 Hz Systems 625 Line/50 Hz Systems
Field:	even/odd/both
Line:	all/line number selectable
Source:	CH 1, CH 2, Ext.
Indicator for trigger action:	LED
External Trigger via:	AUX (0.3 V <sub>pp</sub> , 150 MHz)
Coupling:	AC, DC
Max. input voltage:	100V (DC +peak AC)

**Digital mode**

Pre/Post Trigger:	-100% to +400% related to complete memory
<b>Analog mode</b>	
<b>2nd Trigger</b>	
Min. signal height:	5 mm
Frequency range:	0 - 200 MHz
Coupling:	DC
Level control range:	-10 cm to +10 cm

**Horizontal Deflection**

<b>Analog mode</b>	
Operating modes:	A, ALT (alternating A/B), B
Time base A:	0.5 s/cm - 50 ns/cm (1-2-5 sequence)
Time base B:	20 ms/cm - 50 ns/cm (1-2-5 sequence)
Accuracy A and B:	± 3 %
X Magnification x10:	to 5 ns/cm
Accuracy:	± 5 %

Variable time base A/B:	cont. 1:2:5
Hold Off time:	var. 1:10 (LED-Indication)
Bandwidth X-Amplifier:	0 - 3 MHz [-3 dB]
X Y phase shift < 3°:	< 220 kHz

**Digital mode**

<b>Time base range (1-2-5 sequence)</b>	
Refresh Mode:	20 ms/cm - 5 ns/cm
with Peak Detect:	20 ms/cm - 2 ms/cm (min. Pulse Width 10 ns)
Roll Mode:	50 s/cm - 50 ms/cm

**Accuracy time base**

Time base:	50 ppm
Display:	± 1 %
MEMORY ZOOM:	max. 40,000:1
Bandwidth X-Amplifier:	0 - 100 MHz [-3 dB]
X Y phase shift < 3°:	< 100 MHz

**Digital Storage**

Sampling rate (real time):	Analog channels: 2x 500 MSa/s, 1 GSa/s interleaved
Sampling rate (random sampling):	10 GSa/s
Bandwidth:	2 x 0 - 100 MHz (random)
Memory:	1 M-Samples per channel
Operating modes:	Refresh, Average, Envelope/ Roll (Free Run/Triggered), Peak-Detect
Resolution (vertical):	8 Bit (25 Pts/cm)
<b>Resolution (horizontal):</b>	
Yt:	11 Bit (200 Pts/cm)
XY:	8 Bit (25 Pts /cm)
Interpolation:	Sinx/x, Dot Join (linear), Pulse
Delay:	1 Million x 1/Sampling Rate to 4 Million x 1/Sampling Rate
Display refresh rate:	max.170/s at 1 MPts
Display:	Dots (acquired points only), Vectors (partly interpolated), optimal (complete memory weighting and vectors)
Reference Memories:	9 with 2 kPts each (for recorded signals)
Display:	2 signals of 9 (free selectable)

**FFT Mode**

Display X:	Frequency Range
Display Y:	True rms value of spectrum
Scaling:	Linear or logarithmic
Level display:	dBV, V
Window:	Square, Hanning, Hamming, Blackmann
Control:	Center frequency, Span
Marker:	Frequency, Amplitude
Zoom (frequency axis):	up to x20

**Operation/Measuring/Interfaces**

Operation:	Menu (multilingual), Autoset, help functions (multilingual)
Save/Recall (instrument parameter settings):	9
Signal display:	max. 4 traces
analog:	CH 1, 2 (Time Base A) in combination with CH 1, 2 (Time Base B)
digital:	CH1, 2 and ZOOM or Reference or Mathematics)
<b>USB Memory-Stick:</b>	
Save/Recall external:	
Instrument settings and Signals:	CH 1, 2, ZOOM, Reference and Mathematics
Screen-shot:	as Bitmap
Signal display data (2k per channel):	Binary (orig. ADC-Data), Text (ASCII- Format), CSV (Spread Sheet)

**Operation/Measuring/Interfaces**

<b>Frequency counter:</b>	
6 digit resolution:	>1 MHz - 250 MHz
5 digit resolution:	0.5 Hz - 1 MHz
Accuracy:	50 ppm
<b>Auto Measurements:</b>	
Analog mode:	Frequency, Period, Vdc, Vpp, Vp+, Vp-
also in digital mode:	V <sub>rms</sub> , V <sub>avg</sub>
<b>Cursor Measurements:</b>	
Analog mode:	Δt, 1/Δt (f), t <sub>r</sub> , ΔV, V to GND, ratio X, ratio Y
plus in digital mode:	V <sub>pp</sub> , V <sub>p+</sub> , V <sub>p-</sub> , V <sub>avg</sub> , V <sub>rms</sub> , pulse count
Resolution Readout/Cursor:	1000 x 2000 Pts, Signals: 250 x 2000
Interfaces (plug-in):	USB/RS-232 (HO720)
Optional:	IEEE-488, Ethernet/USB

## Important hints

### Mathematic functions

Number of Formula Sets:	5 with 5 formulas each
Sources:	CH 1, CH 2, Math 1-Math 5
Targets:	5 math. memories, Math 1-5
Functions:	ADD, SUB, 1/X, ABS, MUL, DIV, SQ, POS, NEG, INV
Display:	max. 2 math. memories (Math 1-5)

### Display

CRT:	D14-375GH
Display area (with graticule):	8 cm x 10 cm
Acceleration voltage:	approx. 14 kV

### General Information

<b>Component tester</b>	
Test voltage:	approx. 7 V <sub>rms</sub> (open circuit), approx. 50 Hz
Test current:	max. 7 mA <sub>rms</sub> (short circuit)
Reference Potential :	Ground (safety earth)
Probe ADJ Output:	1 kHz/1 MHz square wave signal 0.2 V <sub>pp</sub> (tr < 4 ns)
Trace rotation:	electronic
Line voltage:	105 - 253 V, 50/60 Hz ± 10 %, CAT II
Power consumption:	47 Watt at 230 V, 50 Hz
Protective system:	Safety class I (EN61010-1)
Weight:	5,6 kg
Cabinet (W x H x D):	285 x 125 x 380 mm
Ambient temperature:	0° C ...+40° C

**Accessories supplied:** Line cord, Operating manual, 2 Probes 10:1 with attenuation ID (HZ200), Windows Software for control and data transfer

#### Optional accessories:

H0730 Dual-Interface Ethernet/USB  
H0740 Interface IEEE-488 (GPIB)  
HZ70 Opto-Interface (with optical fiber cable)

## Important hints

Please check the instrument for mechanical damage or loose parts immediately after unpacking. In case of damage we advise to contact the sender. Do not operate.

### List of symbols used:



Consult the manual



High voltage



Important note



Ground

### Positioning the instrument

As can be seen from the figures, the handle can be set into different positions:

- A = carrying
- B = handle removal and horizontal carrying
- C = horizontal operating
- D and E = operating at different angles
- F = handle removal
- T = shipping (handle unlocked)



#### Attention!

When changing the handle position, the instrument must be placed so that it can not fall (e.g. placed on a table). Then the handle locking knobs must be simultaneously pulled outwards and rotated to the

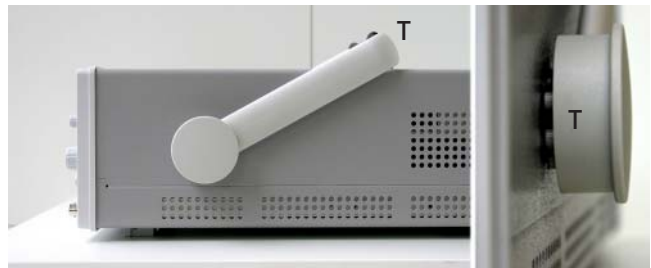
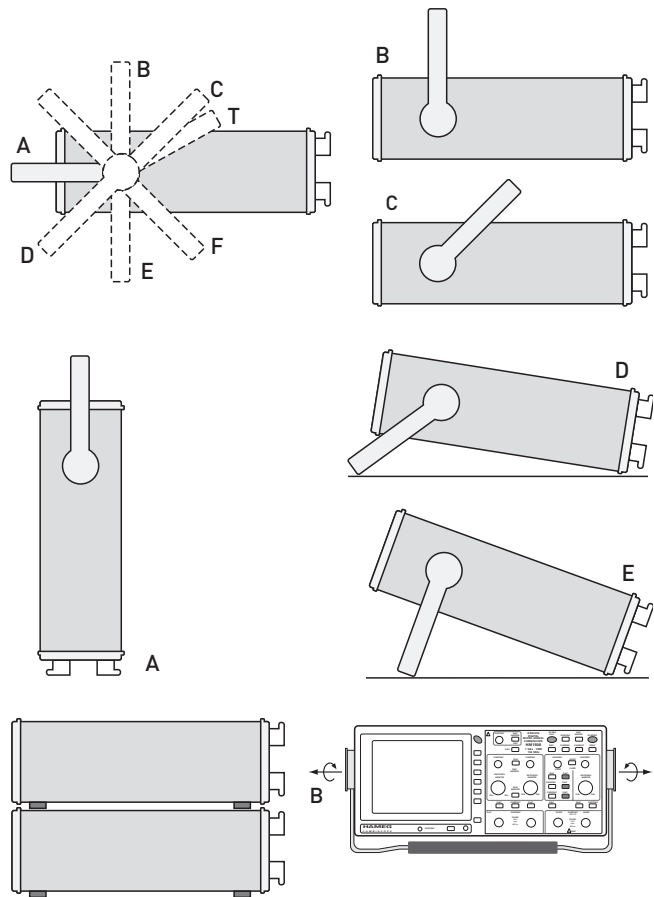

required position. Without pulling the locking knobs they will latch in into the next locking position.

### Handle mounting/dismounting

The handle can be removed by pulling it out further, depending on the instrument model in position B or F.

### Safety

The instrument fulfils the VDE 0411 part 1 regulations for electrical measuring, control and laboratory instruments and was manufactured and tested accordingly. It left the factory in perfect safe condition. Hence it also corresponds to European Standard EN 61010-1 resp. International Standard IEC 1010-1. In order to maintain this condition and to ensure safe operation the user is required to observe the warnings and other directions for use in this manual. Housing, chassis as well as all measuring terminals are connected to safety ground of the mains. All accessible metal parts were tested against the mains with 2200 V<sub>DC</sub>. The instrument conforms to safety class I.

The oscilloscope may only be operated from mains outlets with a safety ground connector. The plug has to be installed prior to connecting any signals. It is prohibited to separate the safety ground connection.

Most electron tubes generate X-rays; the ion dose rate of this instrument remains well below the 36 pA/kg permitted by law.

In case safe operation may not be guaranteed do not use the instrument any more and lock it away in a secure place.

#### Safe operation may be endangered if any of the following was noticed:

- in case of visible damage.
- in case loose parts were noticed
- if it does not function any more.
- after prolonged storage under unfavourable conditions (e.g. like in the open or in moist atmosphere).
- after any improper transport (e.g. insufficient packing not conforming to the minimum standards of post, rail or transport firm)

#### Proper operation

Please note: This instrument is only destined for use by personnel well instructed and familiar with the dangers of electrical measurements. For safety reasons the oscilloscope may only be operated from mains outlets with safety ground connector. It is prohibited to separate the safety ground connection. The plug must be inserted prior to connecting any signals.

#### CAT I

This oscilloscope is destined for measurements in circuits not connected to the mains or only indirectly. Direct measurements, i.e. with a galvanic connection to circuits corresponding to the categories II, III, or IV are prohibited!

The measuring circuits are considered not connected to the mains if a suitable isolation transformer fulfilling safety class II is used. Measurements on the mains are also possible if suitable probes like current probes are used which fulfil the safety class II. The measurement category of such probes must be checked and observed.

#### Measurement categories

The measurement categories were derived corresponding to the distance from the power station and the transients to be expected hence. Transients are short, very fast voltage or current excursions which may be periodic or not.

Measurement CAT IV:

Measurements close to the power station, e.g. on electricity meters

Measurement CAT III:

Measurements in the interior of buildings (power distribution installations, mains outlets, motors which are permanently installed).

Measurement CAT II:

Measurements in circuits directly connected to the mains (household appliances, power tools etc).

Measurement CAT I:

Electronic instruments and circuits which contain circuit breakers resp. fuses.

#### Environmental conditions

The oscilloscope is destined for operation in industrial, business, manufacturing, and living sites.

Operating ambient temperature: 0 to + 40 degrees C. During transport or storage the temperature may be -20 to +55 degrees C. Please note that after exposure to such temperatures or in case of condensation proper time must be allowed until the instrument has reached the permissible range of 0 to + 40 degrees resp. until the condensation has evaporated before it may be turned on! Ordinarily this will be the case after 2 hours. The oscilloscope is destined for use in clean and dry environments. Do not operate in dusty or chemically aggressive atmosphere or if there is danger of explosion.

The operating position may be any, however, sufficient ventilation must be ensured (convection cooling). Prolonged operation requires the horizontal or inclined position.



#### Do not obstruct the ventilation holes!

Specifications are valid after a 20 minute warm-up period between 15 and 30 degr. C. Specifications without tolerances are average values.

#### Warranty and repair

HAMEG instruments are subjected to a rigorous quality control. Prior to shipment each instrument will be burnt in for 10 hours. Intermittent operation will produce nearly all early failures. After burn in, a final functional and quality test is performed to check all operating modes and fulfilment of specifications. The latter is performed with test equipment traceable to national measurement standards.

Statutory warranty regulations apply in the country where the HAMEG product was purchased. In case of complaints please contact the dealer who supplied your HAMEG product.

#### Maintenance

Clean the outer shell using a dust brush in regular intervals. Dirt can be removed from housing, handle, all metal and plastic parts using a cloth moistened with water and 1 % detergent. Greasy dirt may be removed with benzene (petroleum ether) or alcohol, there after wipe the surfaces with a dry cloth. Plastic parts should be treated with an antistatic solution destined for such parts. No fluid may enter the instrument. Do not use other cleansing agents as they may adversely affect the plastic or lacquered surfaces.

#### Line voltage

The instrument has a wide range power supply from 105 to 253 V, 50 or 60 Hz  $\pm$ 10%. There is hence no line voltage selector.

The line fuse is accessible on the rear panel and part of the line input connector. Prior to exchanging a fuse the line cord must be pulled out. Exchange is only allowed if the fuse holder is undamaged, it can be taken out using a screwdriver put into the slot. The fuse can be pushed out of its holder and exchanged.

The holder with the new fuse can then be pushed back in place against the spring. It is prohibited to "repair" blown fuses or to bridge the fuse. Any damages incurred by such measures will void the warranty.

#### Type of fuse:

Size 5 x 20 mm; 250V~, C;  
IEC 127, Bl. III; DIN 41 662  
(or DIN 41 571, Bl. 3).

Cut off: slow blow (T) 0,8A.



## Front Panel Elements – Brief Description

The figures indicate the page for complete discription in the chapter CONTROLS AND READOUT ▼

- |  |   |
|--|---|
| <p><b>1</b> <b>POWER</b> (pushbutton) 26<br/>Turns scope on and off.</p> <p><b>2</b> <b>INTENS</b> (knob) 26<br/>Intensity for trace and readout brightness, focus and trace rotation control.</p> <p><b>3</b> <b>FOCUS, TRACE, MENU</b> (pushbutton) 26<br/>Calls the Intensity Knob menu to be displayed and enables the change of different settings using the INTENS knob. See item 2.</p> <p><b>4</b> <b>CURSOR MEASURE</b> (pushbutton) 27<br/>Calls the "Cursor" menu and offers measurement selection and activation.</p> <p><b>5</b> <b>ANALOG/DIGITAL</b> (pushbutton) 27<br/>Switches between analog (green) and digital mode (blue).</p> <p><b>6</b> <b>STOP / RUN</b> (pushbutton) 28<br/>RUN: Signal data acquisition enabled.<br/>STOP (constantly lit): Signal data acquisition is stopped<br/>STOP (flashing): Signal data acquisition is in progress and and flashing stops when completed.</p> <p><b>7</b> <b>MATH</b> (pushbutton) 28<br/>Calls mathematical function menu if digital mode is present.</p> <p><b>8</b> <b>ACQUIRE</b> (pushbutton) 29<br/>Calls the signal capture and display mode menu in digital mode.</p> <p><b>9</b> <b>SAVE/RECALL</b> (pushbutton) 30<br/>Offers access to the reference signal (digital mode only) and the instrument settings memory.</p> <p><b>10</b> <b>SETTINGS</b> (pushbutton) 31<br/>Opens menu for language and miscellaneous functions; in digital mode also signal display mode.</p> <p><b>11</b> <b>AUTOSET</b> (pushbutton) 32<br/>Enables appropriate, signal related, automatic instrument settings.</p> <p><b>12</b> <b>HELP</b> (pushbutton) 32<br/>Switches help texts regarding controls and menus on and off.</p> <p><b>13</b> <b>POSITION 1</b> (knob) 32<br/>Controls position of actual present functions: Signal (current, reference or mathematics), Cursor and ZOOM (digital).</p> <p><b>14</b> <b>POSITION 2</b> (knob) 33<br/>Controls position of actual present functions: Signal (current, reference or mathematics) Cursor and ZOOM (digital).</p> <p><b>15</b> <b>CH1/2-CURSOR-MA/REF-ZOOM</b> (pushbutton) 34<br/>Calls the menu and indicates the current function of POSITION 1 and 2 controls.</p> <p><b>16</b> <b>VOLTS/DIV-SCALE-VAR</b> (knob) 34<br/>Channel 1 Y deflection coefficient, Y variabel and Y scaling setting.</p> | <p><b>17</b> <b>VOLTS/DIV-SCALE-VAR</b> (knob) 34<br/>Channel 2 Y deflection coefficient, Y variabel and Y scaling setting.</p> <p><b>18</b> <b>AUTO MEASURE</b> (pushbutton) 35<br/>Calls menus and submenus for automatic measurement.</p> <p><b>19</b> <b>LEVEL A/B - FFT-Marker</b> (knob) 36<br/>Trigger level control for A and B Time Base. Marker position shift in FFT mode.</p> <p><b>20</b> <b>MODE</b> (pushbutton) 36<br/>Calls selectable trigger modes.</p> <p><b>21</b> <b>FILTER</b> (pushbutton) 36<br/>Calls menu for trigger filter (coupling), noise reject and slope selection.</p> <p><b>22</b> <b>SOURCE</b> (pushbutton) 37<br/>Calls trigger source menu (e.g. CH1, CH2, Alt. 1/2, External, AC Line).</p> <p><b>23</b> <b>TRIG'd</b> (LED) 38<br/>Lit when the trigger signal meets the trigger conditions.</p> <p><b>24</b> <b>NORM</b> (LED) 38<br/>Lit if NORMAL or SINGLE event triggering is chosen.</p> <p><b>25</b> <b>HOLD OFF</b> (LED) 38<br/>Lit if a hold off time is set (only in analog mode) &gt; 0% in the HOR menu (HOR VAR pushbutton <b>30</b>).</p> <p><b>26</b> <b>X-POS / DELAY</b> (pushbutton) 38<br/>Calls and indicates (colour) the actual function of the HORIZONTAL knob <b>27</b>, (X-POS dark).</p> <p><b>27</b> <b>HORIZONTAL</b> (knob) 39<br/>Changes the X position or in digital mode, the delay time (Pre- or Post-Trigger). In FFT mode for center frequency control.</p> <p><b>28</b> <b>TIME/DIV-SCALE-VAR</b> (knob) 39<br/>Setting of A and B time base (deflection coefficient), time fine control (VAR; only in analog mode) and scaling; Span in FFT mode.</p> <p><b>29</b> <b>MAG x10</b> (pushbutton) 40<br/>10 fold expansion in X direction in analog Yt mode, with simultaneous change of the deflection coefficient display in the readout.</p> <p><b>30</b> <b>HOR / VAR</b> (pushbutton) 40<br/>Calls ZOOM function (digital); in analog mode time base A and B, time base variable and hold off control.</p> <p><b>31</b> <b>CH1 / VAR</b> (pushbutton) 42<br/>Calls channel 1 menu with input coupling (AC, DC, GND), inverting, probe and Y variable control.</p> <p><b>32</b> <b>VERT/XY</b> (pushbutton) 43<br/>Calls vertical mode selection, addition, XY mode and bandwidth limiter.</p> <p><b>33</b> <b>CH2 / VAR</b> (pushbutton) 44<br/>Calls channel 2 menu with input coupling (AC, DC, GND), inverting, probe and Y variable control.</p> |
|--|---|

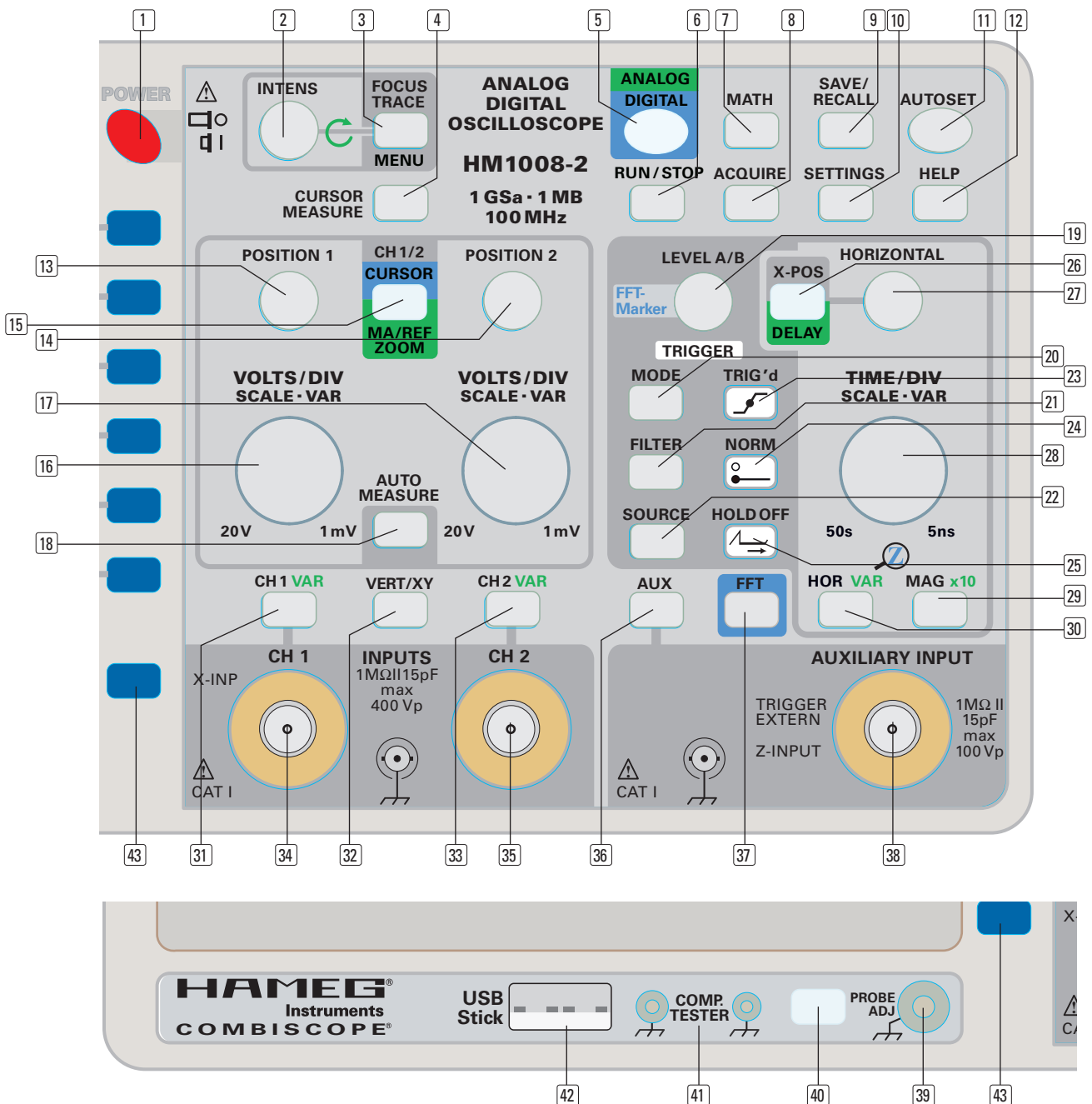

- |  |   |
|--|---|
| <p><b>34</b> Input CH1 (BNC socket) 44<br/>Channel 1 signal input and input for horizontal deflection in XY mode.</p> <p><b>35</b> Input CH2 (BNC socket) 45<br/>Channel 2 signal input.</p> <p><b>36</b> AUX (pushbutton) 45<br/>Calls AUXILIARY INPUT function selection.<br/>Digital mode: External trigger input.<br/>Analog mode: External trigger input or intensity modulation [Z].</p> <p><b>37</b> FFT (pushbutton) 45<br/>Calls FFT menu, offers window and scaling selection, as well as function switch off. Calls FFT menu if FFT mode is present. Direct switch over from digital Yt mode to FFT mode.</p> <p><b>38</b> AUXILIARY INPUT (BNC socket) 46<br/>Input for intensity modulation [Z] (only in analog mode) and external trigger signals.</p> | <p><b>39</b> PROBE / ADJ (socket) 46<br/>Square wave signal output for frequency compensation of x10 probes.</p> <p><b>40</b> PROBE / COMPONENT (pushbutton) 46<br/>Calls menu that offers COMPONENT Tester operation, frequency selection of PROBE ADJ square wave signal, hardware and software information and details about interface (rear side) and "USB Stick" (flash drive) connector.</p> <p><b>41</b> COMPONENT TESTER (2 sockets with 4 mm Ø) 47<br/>Connectors for test leads of the Component Tester. Left socket is galvanically connected with protective earth.</p> <p><b>42</b> USB Stick (USB flash drive connector; front side) 47<br/>Enables storage and loading of signals and signal parameters in connection with USB flash drives.</p> <p><b>43</b> MENU OFF (pushbutton) 47<br/>Switches the menu display off or one step back in the menu hierarchy.</p> |
|--|---|

## Basic signal measurement

## Signals which can be measured

The following description pertains to analog and digital operation. The different specifications in both operating modes should be kept in mind.

The oscilloscope HM1008-2 can display all repetitive signals with a fundamental repetition frequency of at least 100 MHz. The frequency response is 0 to 100 MHz (-3 dB). The vertical amplifiers will not distort signals by overshoots, undershoots, ringing etc.

Simple electrical signals like sine waves from line frequency ripple to hf will be displayed without problems. However, when measuring sine waves, the amplitudes will be displayed with an error increasing with frequency. At 80 MHz the amplitude error will be around -10 %. As the bandwidths of individual instruments will show a certain spread (the 100 MHz is a guaranteed minimum) the actual measurement error for sine waves cannot be exactly determined.

Pulse signals contain harmonics of their fundamental frequency which must be represented, so the maximum useful repetition frequency of non sinusoidal signals is much lower than 100 MHz (5 to 10 times). The criterion is the relationship between the rise times of the signal and the scope; the scope's rise time should be <1/3 of the signal's rise time if a faithful reproduction without too much rounding of the signal shape is to be preserved.

The display of a mixture of signals is especially difficult if it contains no single frequency with a higher amplitude as the scope's trigger system normally discriminates by amplitude. This is typical of burst signals for example. Display of such signals may require using the HOLD OFF control.

Composite video signals may be displayed easily as the instrument has a tv sync separator.

The maximum sweep speed of 5 ns/cm allows sufficient time resolution, e.g. a 100MHz sine wave will be displayed one period per 2 cm.

The vertical amplifier inputs may be DC or AC coupled. Use DC coupling only if necessary and preferably with a probe.

Low frequency signals when AC coupled will show tilt (AC low frequency -3 dB point is 1.6 Hz), so if possible use DC coupling. Using a probe with 10:1 or higher attenuation will lower the -3 dB point by the probe factor. If a probe cannot be used due to the loss of sensitivity, DC coupling the scope and an external large capacitor may help which, of course, must have a sufficient DC rating. Care must be taken, however, when charging and discharging a large capacitor.

DC coupling is preferable with all signals of varying duty cycle, otherwise the display will move up and down depending on the duty cycle. Of course, pure DC can only be measured with DC coupling.

The readout will show which coupling was chosen: = stands for DC, ~ stands for AC.

## Amplitude of signals

In contrast to the general use of rms values in electrical engineering oscilloscopes are calibrated in  $V_{pp}$  as that is what is displayed.

To derive rms from  $V_{pp}$ : divide by 2.84. To derive  $V_{pp}$  from rms: multiply by 2.84.

## Values of a sine wave signal

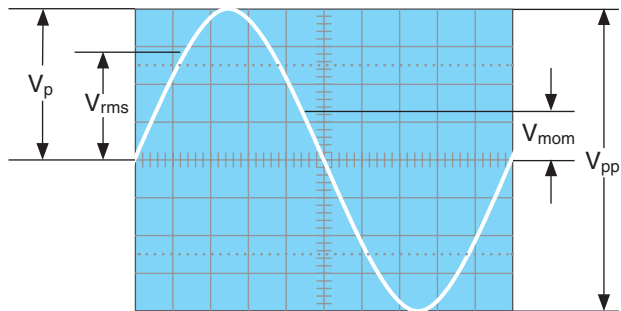

$V_{rms}$  = rms value

$V_{pp}$  = pp - value

$V_{mom}$  = momentary value, depends on time vs. period.

The minimum signal for a one cm display is  $1 \text{ mV}_{pp} \pm 5\%$  provided  $1 \text{ mV/cm}$  was selected and the variable is in the calibrated position.

The available sensitivities are given in  $\text{mV}_{pp}$  or  $V_{pp}$ . The cursors lets you read the amplitudes of the signals immediately on the readout as the attenuation of probes is automatically taken into account. Even if the probe attenuation was selected manually this will be overridden if the scope identifies a probe with different identification contact. The readout will always give the true amplitude.

It is important that the variable be in its calibrated position. The sensitivity may be continuously decreased by using the variable (see chapt. Controls and Readout). Each intermediate value between the calibrated positions 1-2-5 may be selected. Thus a maximum of  $400 V_{pp}$  may be displayed without using a probe ( $20 \text{ V/div} \times 8 \text{ cm screen} \times 2.5 \text{ variable}$ ).

Amplitudes may be directly read off the screen by measuring the height and multiplying by the  $\text{V/div.}$  setting.



**Please note: Without a probe the maximum permissible voltage at the inputs must not exceed  $400 V_p$  irrespective of polarity.**

In case of signals with a DC content the peak value DC + AC peak must not exceed + or -  $400 V_p$ . Pure AC of up to  $800 V_{pp}$  is permissible.



**If probes are used their possibly higher ratings are only usable if the scope is DC coupled.**

In case of measuring DC with a probe while the scope input is AC coupled the capacitor in the scope input will see the input DC voltage as it is in series with the internal  $1 \text{ M}\Omega$  resistor. This means that the maximum DC voltage (or DC + peak AC) is that of the scope input, i.e.  $400 V_p$ ! With signals which contain DC and AC the DC content will stress the input capacitor while the AC content will be divided depending on the AC impedance

of the capacitor. It may be assumed that this is negligible for frequencies >40 Hz.

Considering the foregoing you may measure DC signals of up to 400 V or pure AC signals of up to 800 V<sub>pp</sub> with a HZ200 probe. Probes with higher attenuation like HZ53 100:1 allow you to measure DC up to 1200 V and pure AC of up to 2400 V<sub>pp</sub>. (Please note the derating for higher frequencies, consult the HZ53 manual). Stressing a 10:1 probe beyond its ratings will risk destruction of the capacitor bridging the input resistor with possible ensuing damage of the scope input!

If the residual ripple of a high voltage is to be measured, a high voltage capacitor may be inserted in front of a 10:1 probe, it will take most of the voltage as the value of the probe's internal capacitor is very low, 22 to 68 nF will be sufficient.

If the input selector is switched to Ground the reference trace on the screen may be positioned at graticule center or elsewhere.

### DC and AC components of an input signal

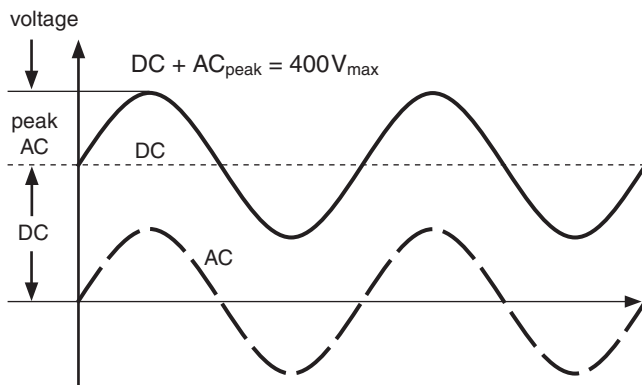

The dashed curve shows an AC signal symmetrical about zero. If there is a DC component the peak value will be DC + AC peak.

### Timing relationships

In most cases repetitive signals must be measured. The repetition frequency of a signal is equal to the number of periods per second. Depending on the TIME/DIV setting one or more periods or part of a period of the signal may be displayed. The time base settings will be indicated on the readout in s/cm, ms/cm, µs/cm and ns/cm (1 cm is the equivalent of 1 div. on the crt graticule). Also the cursors may be used to measure the frequency or the period.

Without cursor the cycle duration can be determined by multiplying the length (cm) with the (calibrated) time coefficient. The reciprocal value is the frequency.

If portions of the signal are to be measured use delayed sweep (analog mode) or zoom (digital mode) or the magnifier x10. Use the HORIZONTAL positioning control to shift the portion to be zoomed into the screen center.

Pulse signals are characterized by their rise and fall times which are measured between the 10 % and 90 % portions. The following example uses the internal graticule of the crt, but also the cursors may be used for measurement.

#### Measurement:

- Adjust the rising portion of the signal to 5 cm.
- Position the rising portion symmetrically to the graticule centre line, using both Y and X positioning controls.

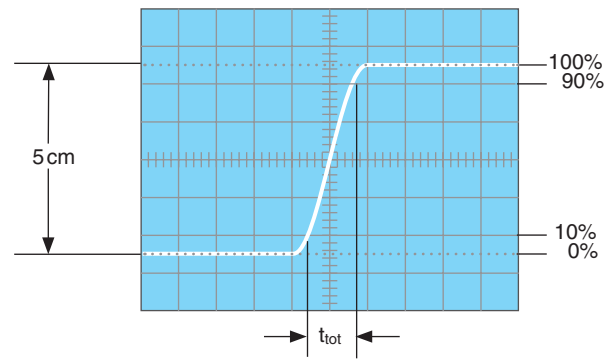

- Notice the intersections of the signal with the 10 and 90 % lines and project these points to the centre line in order to read the time difference.

In the example it was 1.6 cm at 5 ns/cm equals 8 ns rise time.

When measuring very short rise times close to the scope rise time it is necessary to subtract the scope's (and if used, the probe's) rise times geometrically from the rise time as seen on the screen. The true signal rise time will become:

$$t_a = \sqrt{t_{tot}^2 - t_{osc}^2 - t_t^2}$$

t<sub>tot</sub> is the rise time seen, t<sub>osc</sub> is the scope's own rise time (3.5 ns with the HM1008-2), t<sub>t</sub> is the rise time of the probe, e.g. 2 ns. If the signal's rise time is > 34 ns, the rise times of scope and probe may be neglected.

$$t_a = \sqrt{8^2 - 3.5^2 - 2^2} = 6.9 \text{ ns}$$

For the measurement of rise times proceed mainly as outlined above, however rise times may be measured anywhere on the screen. It is mandatory that the rising portion of the signal be measured in full and that the 10 to 90 % are observed. In case of signals with over or undershoot, the 0 and 100 % levels are those of the horizontal portions of the signal, i.e. the over/undershoot must be disregarded for rise and fall time measurements. Also, glitches should be disregarded. If signals are very distorted, however, rise and fall time measurements may be of no value.

For most amplifiers, even if their pulse behaviour is far from ideal, the following relationship holds:

$$t_a = \frac{350}{B} \quad B = \frac{350}{t_a}$$

$$tr/ns = 350/Bandwidth/MHz$$

### Connection of signals

In most cases pressing the AUTOSET button will yield a satisfactory display (see AUTOSET). The following relates to special cases where manual settings will be advisable. For a description of controls refer to "Controls and Readout".

 **Take care when connecting unknown signals to the inputs!**

It is recommended to use probes whenever possible. Without a probe start with the attenuator set to its 20 V/cm position. If the trace disappears the signal amplitude may be too large, overdriving the vertical amplifier and/or its DC content may be too high. Reduce the sensitivity until the trace reappears on screen. If calibrated measurements are desired it will be necessary to use a probe if the signal becomes > 160 V<sub>p</sub>. Check the probe specifications in order to avoid overstressing. If the

time base is set too fast the trace may become invisible, then reduce the time base speed.

If no probe is used at least screened cable should be used, such as HZ32 or HZ34. However, this is only advisable for low impedance sources or low frequencies (<50 kHz). With high frequencies impedance matching will be necessary.

Non sinusoidal signals require impedance matching, preferably at both ends. At the scope input a feed through 50Ω-termination will be required. HAMEG offers a HZ22 termination. If proper terminations are not used, sizeable pulse aberrations will result. Also sine wave signals of > 100 kHz should be properly terminated. Most generators control signal amplitudes only if correctly terminated.

HZ22 may only be used up to 7 V<sub>rms</sub> or 20 V<sub>pp</sub> i.e. 1 W.

For probes, terminations are neither required nor allowed, they would ruin the signal.

Probes feature very low loads at fairly low frequencies: 10 MΩ in parallel with few pF, valid up to several hundred kHz. However, the input impedance diminishes with rising frequency to quite low values. This has to be borne in mind as probes are, e.g., entirely unsuitable to measure signals across high impedance high frequency circuits such as bandfilters etc.! Here only FET probes can be used. Use of a probe as a rule will also protect the scope input due to the high probe series resistance (9 MΩ). As probes cannot be calibrated precisely enough during manufacturing, individual calibration with the scope input used is mandatory! (See Probe Calibration).

Passive probes will, as a rule, decrease the scope bandwidth and increase the rise time. We recommend to use HZ200 probes in order to make maximum use of the combined bandwidth. HZ200 features 2 additional hf compensation adjustments.

Whenever the DC content is > 400 V, DC coupling must be used in order to prevent overstressing the scope input capacitor. This is especially important if a 100:1 probe is used as this is specified for 1200 V<sub>DC</sub> + peak AC.

AC coupling of low frequency signals may produce tilt.

If the DC content of a signal must be blocked, it is possible to insert a capacitor of proper size and voltage rating in front of the probe, a typical application would be a ripple measurement.

When measuring small voltages the selection of the ground connection is of vital importance. It should be as close to voltage take off point as possible, otherwise ground currents may deteriorate the measurement. The ground connections of probes are especially critical, they should be as short as possible and of large diameter.

 **If a probe is to be connected to a BNC connector use a probe tip to BNC adapter.**

If ripple or other interference is visible, especially at high sensitivity, one possible reason may be multiple grounding. The scope itself and most other equipment are connected to safety ground, so ground loops may exist. Also, most instruments will have capacitors between line and safety ground installed, which conduct current from the live wire into the safety ground.

## First time operation and initial adjustments

Prior to first time operation the connection between the instrument and safety ground must be ensured, hence the plug must be inserted first.

Use the red POWER pushbutton to turn the scope on. Several displays will light up. The scope will then assume the set up selected before it was turned off. If no trace and no readout are visible after approximately 20 sec, push the AUTOSSET button.

As soon as the trace becomes visible select an average intensity with INTENS, then select FOCUS and adjust it, then select TRACE ROTATION and adjust for a horizontal trace.

With respect to crt life, use only as much intensity as necessary and convenient under given ambient light conditions. When not in use, turn the intensity fully off rather than switching the scope on and off too much as this is detrimental to the life of the crt heater. Do not allow a stationary point on the screen, it might burn the crt phosphor.

With unknown signals start with the lowest sensitivity 20 V/cm, connect the input cables to the scope, and then to the measuring object which should be de energized beforehand. Then turn the measuring object on. If the trace disappears, push AUTOSSET.

### Trace rotation TR

The crt has an internal graticule. In order to adjust the deflected beam with respect to this graticule the Trace Rotation control is provided. Select the function Trace Rotation and adjust for a trace which is exactly parallel to the graticule.

### Probe adjustment and use

In order to ensure proper matching of the probe used to the scope input impedance the oscilloscope contains a calibrator with short rise time and an amplitude of 0.2 V<sub>pp</sub> ± 1 %, equivalent to 4 cm at 5 mV/cm when using 10:1 probes.

The inner diameter of the calibrator connector is 4.9 mm and standardized for series F probes. Using this special connector is the only way to connect a probe to a fast signal source minimizing signal and ground lead lengths and to ensure true displays of pulse signals.

### 1 kHz – adjustment

This basic adjustment will ensure that the capacitive attenuation equals the resistive attenuation thus rendering the attenuation of the probe independent of frequency. 1:1 probes can not be adjusted and need no such adjustment anyway. Prior to adjustment make sure that the trace rotation adjustment has been performed.

Connect the 10:1 probe to the input. Use DC coupling. Set

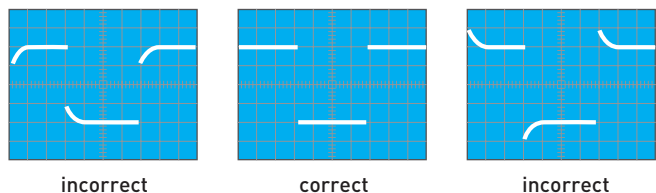

the VOLTS/DIV to 5 mV/cm and TIME/DIV to 0.2 ms/cm, both calibrated. Insert the probe tip into the calibrator connector PROBE ADJ.

You should see 2 signal periods. Adjust the compensation capacitor (see the probe manual for the location) until the square wave tops are exactly parallel to the graticule lines (see picture 1 kHz). The signal height should be 4 cm  $\pm$  1.6 mm (3% oscilloscope and 1% probe tolerance). The rising and falling portions of the square wave will be invisible.

### 1 MHz adjustment

The HAMEG probes feature additional adjustments in the compensation box which allow you to optimise their hf behaviour. This adjustment is a precondition for achieving the maximum bandwidth with the probe and a minimum of pulse aberrations.

This adjustment requires a calibrator with a short rise time (typ. 4 ns) and a 50Ω output, a frequency of 1 MHz, an amplitude of 0.2 V<sub>pp</sub>. The PROBE ADJ. output of the scope fulfils these requirements.

Connect the probe to the scope input with which it is to be adjusted. Select the PROBE ADJ. signal 1 MHz. Select DC coupling and 5 mV/cm with VOLTS/DIV. and 0.1 μs/cm with TIME/DIV., both calibrated. Insert the probe tip into the calibrator output connector. The screen should show the signal, and the rise and fall times will be visible. Watch the rising portion and the top left pulse corner, consult the manual for the location of the adjustments.

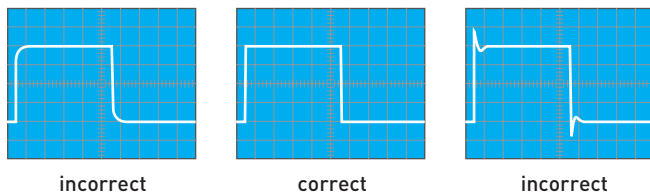

#### The criteria for a correct adjustment are:

- short rise time, steep slope.
- clean top left corner with minimum over or undershoot, flat top.

After adjustment check the amplitude which should be the same as with 1 kHz.

It is important to first adjust 1 kHz, then 1 MHz. It may be necessary to check the 1 kHz adjustment again.

Please note that the frequency of the calibrator signals is not calibrated and thus must not be used to check the time base accuracy, also the duty cycle may differ from 1:1. The probe adjustment is completed if the pulse tops are horizontal and the amplitude calibration is correct.

## Operating modes of the vertical amplifier

The controls most important for the vertical amplifier are: VERT/XY (32), CH1 (31), CH2 (33). They give access to the menus containing the operating modes and the parameters of the individual channels.

Changing the operating mode is described in the chapter: "Controls and Readout".

**Remark: Any reference to "both channels" always refers to channels 1 and 2.**

Usually oscilloscopes are used in the Yt mode. In analog mode the amplitude of the measuring signal will deflect the trace vertically while a time base will deflect it from left to right.

The vertical amplifiers offer these modes:

- One signal only with CH1.
- One signal only with CH2.
- Two signals with channels 1 and 2 (DUAL trace mode)

In DUAL mode both channels are operative. In analog mode the method of signal display is governed by the time base (see also "Controls and Readout"). Channel switching may either take place after each sweep (alternate) or during sweeps at high frequency (chopped).

The normal choice is alternate, however, at slow time base settings the channel switching will become visible and disturbing, when this occurs select the chopped mode in order to achieve a stable quiet display.

In DIGITAL mode no channel switching is necessary as each input has its own A/D converter, signal acquisition is simultaneous.

In ADD mode the two channels 1 and 2 are algebraically added ( $\pm$ CH1  $\pm$ CH2). With + polarity the channel is normal, with - polarity inverted. If + Ch1 and - CH2 are selected the difference will be displayed or vice versa.

#### Same polarity input signals:

- Both channels not inverted: = sum
- Both channels inverted: = sum
- Only one channel inverted: = difference

#### Opposite polarity input signals:

- Both channels not inverted: = difference
- Both channels inverted: = difference
- One channel inverted: = sum.

Please note that in ADD mode both position controls will be operative. The INVERT function will not affect positioning.

Often the difference of two signals is to be measured at signal points which are both at a high common mode (CM) potential. While this one typical application of the difference mode one important precaution has to be borne in mind: The oscilloscope vertical amplifiers are two separate amplifiers and do not constitute a true difference amplifier with both a high CM rejection and a high permissible CM range! Therefore please observe the following rule: Always look at the two signals in the one channel only or the dual modes (not in Add mode) and make sure that they are within the permissible input signal range; this is the case if they can be displayed in these modes. Only then switch to ADD. If this precaution is disregarded grossly false displays

may result as the input range of one or both amplifiers may be exceeded.

Another precondition for obtaining true displays is the use of two identical probes at both inputs. But note that normal probe tolerances (percent) will cause the CM rejection to be expected to be rather moderate. In order to obtain the best possible results proceed as follows: First adjust both probes as carefully as possible, then in Add mode select the same sensitivity at both inputs and connect both probes to the output of a pulse generator with sufficient amplitude to yield a good display. Re-adjust one (!) of the probe adjustment capacitors for a minimum of over or undershoot. As there is no adjustment provided with which the resistors can be matched a residual pulse signal will be unavoidable. When making difference measurements it is good practice to first connect the ground cables of the probes to the object prior to connecting the probe tips. There may be high potentials between the object and the scope. If a probe tip is connected first there is danger of overstressing the probe or/and the scope inputs! Never perform difference measurements without both probe ground cables connected.

**XY operation**

This mode is accessed by VERT/XY (32) > XY. In analog mode the timebase will be turned off. The channel 1 signal will deflect in X direction (X INP. = horizontal input), hence the input attenuators, the variable and the POSITION 1 control will be operative. The HORIZONTAL control will also remain functional.

Channel 2 will deflect in Y direction.

The x10 magnifier will be inoperative in XY mode. Please note the differences in the Y and X bandwidths, the X amplifier has a lower -3 dB frequency than the Y amplifier. Consequently the phase difference between X and Y will increase with frequency. In XY mode the X signal (CH1 = X INP). cannot be inverted.

**The XY mode may generate Lissajous figures which simplify some measuring tasks and make others possible:**

- Comparison of two signals of different frequency or adjustment of one frequency until it is equal to the other and becomes synchronized.
- This is also possible for multiples or fractions of one of the frequencies.

**Phase measurements with Lissajous figures**

The following pictures show two sine waves of equal amplitude and frequency but differing phase.

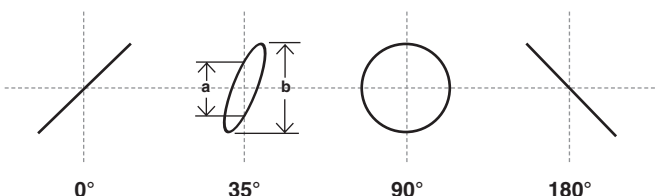

Calculation of the phase angle between the X and Y signals (after reading a and b off the screen) is possible using the following formulas and a pocket calculator with trigonometric functions. This calculation is independent of the signal amplitudes:

**Please note:**

- As the trigonometric functions are periodic, limit the calculation to angles <90 degrees. This is where this function is most useful.

- Do not use too high frequencies, because, as explained above, the two amplifiers are not identical, their phase difference increases with frequency. The spec gives the frequency at which the phase difference will stay <3 degrees.
 
$$\sin \varphi = \frac{a}{b}$$

$$\cos \varphi = \sqrt{1 - \left(\frac{a}{b}\right)^2}$$

$$\varphi = \arcsin \frac{a}{b}$$

- The display will not show which of the two frequencies does lead or lag. Use a CR combination in front of the input of the frequency tested. As the input has a 1 MΩ resistor it will be sufficient to insert a suitable capacitor in series. If the ellipse increases with the C compared to the C short circuited the test signal will lead and vice versa. This is only valid <90 degrees. Hence C should be large and just create a barely visible change.

If in XY mode, one or both signals may disappear, showing only a line or a point, mostly very bright. In case of only a point there is danger of phosphor burn, so turn the intensity down immediately; if only a line is shown the danger of burn will increase the shorter the line is. Phosphor burn is permanent.

**Measurement of phase differences in dual channel Yt mode**

**Please note:** Do not use "alternate trigger" because the time differences shown are arbitrary and depend only on the respective signal shapes! Make it a rule to use alternate trigger only in rare special cases.

The best method of measuring time or phase differences is using the dual channel Yt mode. Of course, only times may be read off the screen, the phase must then be calculated as the frequency is known. This is a much more accurate and convenient method as the full bandwidth of the scope is used, and both amplifiers are almost identical. Trigger the time base from the signal which will be the reference. It is necessary to position both traces without signal exactly on the graticule center (POSITION 1 and 2). The variables and trigger level controls may be used, this will not influence the time difference measurement. For best accuracy display only one period at high amplitude and observe the zero crossings. One period equals 360 degrees. It may be advantageous to use ac coupling if there is an offset in the signals.

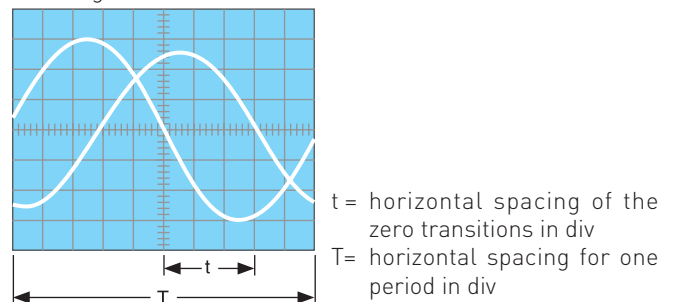

In this example t = 3 cm and T = 10 cm, the phase difference in degrees will result from:

$$\varphi^\circ = \frac{t}{T} \cdot 360^\circ = \frac{3}{10} \cdot 360^\circ = 108^\circ$$

or in angular units:

$$\arcsin \varphi^\circ = \frac{t}{T} \cdot 2\pi = \frac{3}{10} \cdot 2\pi = 1,885 \text{ rad}$$

Very small phase differences with moderately high frequencies may yield better results with Lissajous figures.

However, in order to get higher precision it is possible to switch to higher sensitivities after accurately positioning at graticule

centre, thus overdriving the inputs resulting in sharper zero crossings. Also, it is possible to use half a period over the full 10 cm. As the time base is quite accurate, increasing the time base speed after adjusting for e.g. one period = 10 cm and positioning the first crossing on the first graticule line will also give better resolution.

### Measurement of amplitude modulation

Please note: Use this only in analog mode because in digital mode alias displays may void the measurement! For the display of low modulation frequencies a slow time base (TIME/DIV) has to be selected in order to display one full period of the modulating signal. As the sampling frequency of any digital oscilloscope must be reduced at slow time bases it may become too low for a true representation.

The momentary amplitude at time t of a hf carrier frequency modulated by a sinusoidal low frequency is given by:

$$u = U_T \cdot \sin \Omega t + 0,5m \cdot U_T \cdot \cos (\Omega - \omega) t - 0,5m \cdot U_T \cdot \cos (\Omega + \omega) t$$

where:  $U_T$  = amplitude of the unmodulated carrier  
 $\Omega = 2\pi F$  = angular carrier frequency  
 $\omega = 2\pi f$  = modulation angular frequency  
 $m$  = modulation degree ( $\leq 1 \hat{=} 100\%$ )

In addition to the carrier a lower side band  $F - f$  and an upper side band  $F + f$  will be generated by the modulation.

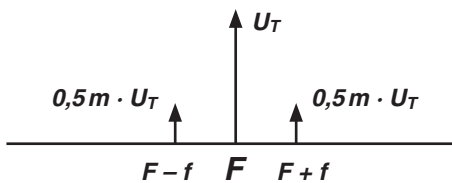

Picture 1: Amplitudes and frequencies with AM (m = 50 %) of the spectra

As long as the frequencies involved remain within the scope's bandwidth the amplitude modulated HF can be displayed. Preferably the time base is adjusted so that several signal periods will be displayed. Triggering is best done from the modulation frequency. Sometimes a stable displayed can be achieved by adjusting the time base variable.

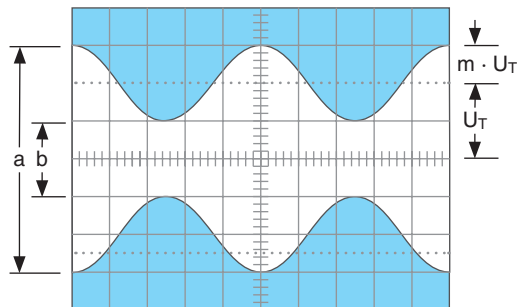

Picture 2: Amplitude modulated hf. F = 1 MHz, f = 1 kHz, m = 50 %, U<sub>T</sub> = 28,3 mV<sub>rms</sub>  
 Set the scope controls as follows in order to display the picture 2 signal:

- CH1 only, 20 mV/cm, AC
- TIME/DIV: 0.2 ms/cm
- Triggering: NORMAL, AC, internal.
- Use the time base variable or external triggering.

Reading a and b off the screen the modulation degree will result:

$$m = \frac{a-b}{a+b} \text{ bzw. } m = \frac{a-b}{a+b} \cdot 100 [\%]$$

$$a = U_T (1 + m) \text{ and } b = U_T (1 - m)$$

When measuring the modulation degree the amplitude and time variables can be used without any influence on the result.

## Triggering and time base

The most important controls and displays for these functions are to be found in the shaded TRIGGER area, they are described in „Controls and Readout“.-

In YT mode the signal will deflect the trace vertically while the timebase will deflect it horizontally, the speed can be selected. In general periodic voltage signals are displayed with a periodically repeating time base. In order to have a stable display, successive periods must trigger the time base at exactly the same time position of the signal (amplitude and slope).

**Pure DC can not trigger the time base, a voltage change is necessary.**

Triggering may be internal from any of the input signals or externally from a time related signal.

For triggering a minimum signal amplitude is required which can be determined with a sine wave signal. With internal triggering the trigger take off within the vertical amplifiers is directly following the attenuators. The minimum amplitude is specified in mm on the screen. Thus it is not necessary to give a minimum voltage for each setting of the attenuator.

For external triggering the appropriate input connector is used, thus the input amplitude necessary is given in V<sub>pp</sub>. The voltage for triggering may be much higher than the minimum, however, it should be limited to 20 times the minimum. Please note that for good triggering the external voltage should be a good deal above the minimum. The scope features two trigger modes to be described in the following:

### Automatic peak triggering (MODE menu)

Consult the chapters MODE (20) > AUTO, LEVEL A/B (19), FILTER (21) and SOURCE (22) in "Controls and Readout". Using AUTOSSET this trigger mode will be automatically selected. With DC coupling and with alternate trigger this mode will be left while the automatic triggering will remain.

Automatic triggering causes a new time base start after the end of each foregoing sweep and after the hold off time has elapsed even without any input signal. Thus there is always a visible trace in analog or digital mode. The position of the trace(s) without any signal is then given by the settings of the POSITION controls.

As long as there is a signal, scope operation will not need more than a correct amplitude and time base setting. With signals <20 Hz their period is longer than the time the auto trigger

circuit will wait for a new trigger, consequently the auto trigger circuit will start the time base irrespective of the signal. Hence the the display will not be triggered and free run, quite independent of the signal's amplitude which may be much larger than the minimum.

Also in auto peak trigger mode, the trigger level control is active. Its range will be automatically adjusted to coincide with the signal's peak to peak amplitude, hence the name. The trigger point will thus become almost independent of signal amplitude. This means that even if the signal is decreased the trigger will follow, the display will not lose trigger. As an example: the duty cycle of a square wave may change between 1:1 and 100:1 without losing the trigger.

Depending on the signal the LEVEL A/B control may have to be set to one of its extreme positions.

The simplicity of this mode recommends it for most uncomplicated signals. It is also preferable for unknown signals.

This trigger mode is independent of the trigger source and usable as well for internal as external triggering. But the signal must be > 20 Hz.

### Normal trigger mode (See menu MODE)

Consult the chapters: MODE (20) > AUTO, LEVEL A/B (19), FILTER (21) and SOURCE (22) in "Controls and Readout". Information about how to trigger very difficult signals can be found in the HOR VAR menu (30) where the functions time base, fine adjustment VAR, HOLD OFF time setting, and time base B operation are explained.

With normal triggering and suitable trigger level setting, triggering may be chosen on any point of the signal slope. Here, the range of the trigger level control depends on the trigger signal amplitude. With signals <1 cm care is necessary.

In normal mode triggering there will be no trace visible in the absence of a signal or when the signal is below the minimum trigger amplitude requirement!

Normal triggering will function even with complicated signals. If a mixture of signals is displayed triggering will require repetition of amplitudes to which the level can be set. This may require special care in adjustment.

### Slope selection (Menu FILTER)

After entering FILTER (21) the trigger slope may be selected using the function keys. See also "Controls and Readout". AUTOSET will not change the slope.

Positive or negative slope may be selected in auto or normal trigger modes. Also, a setting "both" may be selected which will cause a trigger irrespective of the polarity of the next slope.

Rising slope means that a signal comes from a more negative potential and rises towards a positive one. This is independent of the vertical position. A positive slope may exist also in the negative portion of a signal. This is valid in automatic and normal modes.

### Trigger coupling (Menu: FILTER)

Consult chapters: MODE (20) > AUTO, LEVEL A/B (19), FILTER (21) and SOURCE (22) in "Controls and Readout". In AUTOSET DC

coupling will be used unless ac coupling was selected before. The frequency responses in the diverse trigger modes may be found in the specifications.

With internal DC coupling with or without LF filter use normal triggering and the level control. The trigger coupling selected will determine the frequency response of the trigger channel.

#### AC:

This is the standard mode. Below and above the fall off of the frequency response, more trigger signal will be necessary.

#### DC:

With direct coupling there is no lower frequency limit, so this is used with very slowly varying signals. Use normal triggering and the level control. This coupling is also indicated if the signal varies in its duty cycle.

#### HF:

A high pass is inserted in the trigger channel, thus blocking low frequency interference like flicker, noise etc.

#### Noise Reject:

This trigger coupling mode or filter is low pass suppressing high frequencies. This is useful in order to eliminate hf interference of low frequency signals. This filter may be used in combination with DC or ac coupling, in the latter case very low frequencies will also be attenuated.

#### LF:

This is also a low pass filter with a still lower cut off frequency than above which also can be combined with DC or ac coupling. Selecting this filter may be more advantageous than using DC coupling in order to suppress noise producing jitter or double images. Above the pass band the necessary trigger signal will rise. Together with ac coupling there will also result a low frequency cut off.

### Video (tv triggering)

Selecting MODE >Video will activate the built in TV sync separator. It separates the sync pulses from the picture content and thus enables stable triggering independent of the changing video content.

Composite video signals may be positive or negative. The sync pulses will only be properly extracted if the polarity is correct. The definition of polarity is as follows: if the video is above the sync it is positive, otherwise it is negative. The polarity can be selected after selecting FILTER. If the polarity is wrong the display will be unstable or not triggered at all as triggering will then initiated by the video content. With internal triggering a minimum signal height of 5 mm is necessary.

The PAL sync signal consists of line and frame signals which differ in duration. Pulse duration is 5  $\mu$ s in 64  $\mu$ s intervals. Frame sync pulses consist of several pulses each 28  $\mu$ s repeating each half frame in 20 ms intervals.

Both sync pulses differ in duration and in their repetition intervals. Triggering is possible with both.

### Frame sync pulse triggering

#### Remark:

Using frame sync triggering in dual trace chopped mode may result in interference, so here the dual trace alternate

mode should be chosen. It may also be necessary to turn the readout off.

In order to achieve frame sync pulse triggering call MODE, select video signal triggering and then FILTER to select frame triggering. It may be selected further whether "all", "only even" or "only odd" half frames shall trigger. Of course, the correct tv standard must be selected first of all (625/50 or 525/60).

The time base setting should be selected to suit, with 2 ms/cm a complete half frame will be displayed. Frame sync pulses consist of several pulses with a half line rep rate.

### Line sync pulse triggering

In order to choose line sync triggering call MODE and select VIDEO, enter FILTER, make sure that the correct video standard is selected (625/50 or 525/60) and select Line. If ALL was selected each line sync pulse will trigger. It is also possible to select a line number "LINE No."

In order to display single lines a time base setting of TIME/DIV. = 10  $\mu$ s/cm is recommended, this will show 1½ lines. In general the composite video signal contains a high DC component which can be removed by ac coupling, provided the picture is steady. Use the POSITION control to keep the display within the screen. If the video content changes such as with a regular TV program, only DC coupling is useful, otherwise the vertical position would continuously move.

The sync separator is also operative with external triggering. Consult the specifications for the permissible range of trigger voltage. The correct slope must be chosen as the external trigger may have a different polarity from the composite video. In case of doubt display the external trigger signal.

### LINE trigger

Consult SOURCE [22] in "Controls and Readout" for specific information.

If the readout shows Tr:Line the trigger signal will be internally taken from the line (50 or 60 Hz).

This trigger signal is independent of the scope input signals and is recommended for all signals synchronous with the line. Within limits this will also be true for multiples or fractions of the line frequency. As the trigger signal is taken off internally there is no minimum signal height on the screen for a stable display. Hence even very small voltages like ripple or line frequency interference can be measured.

Please note that with line triggering the polarity switching will select either the positive or negative half period of the line, not the slope. The trigger level control will move the trigger point over most of a half wave.

Line frequency interference may be checked using a search coil which preferably should have a high number of turns and a shielded cable. Insert a 100 $\Omega$  resistor between the center conductor and the BNC connector. If possible the coil should be shielded without creating a shorted winding.

### Alternate trigger

This mode (only available in analog mode) is selected with SOURCE [22] >Alt. 1/2. The readout will display Tr:alt, but no trigger point symbol indicating level and time position. Instead

an arrow pointing upwards will indicate the trigger time position if this lies within the screen area. The Trigger symbol is not indicated.

This trigger mode is to be used with greatest care and should be an exception rather than the rule, because the time relationships visible on the screen are completely meaningless, they depend only on the shape of the signals and the trigger level!

In this mode the trigger source will be switched together with the channel switching, so that when CH1 is displayed in the dual channel alternate mode, the trigger is taken from CH1 and when CH2 is displayed, the trigger is taken from CH2. This way two uncorrelated signals can be displayed together. If this mode is inadvertently chosen the time relationships between the signals will also be lost when both signals are correlated! (Except for the special case that both happen to be square waves with extremely fast rise times). Of course, this trigger mode is only possible in the dual channel alternate mode and also not with external or line trigger. AC coupling is recommended for most cases.

### External triggering

If Yt (time base) mode is present, this trigger mode may be selected with SOURCE [22] >Extern. The readout will display Tr:ext. The AUXILIARY INPUT will be the input for the external trigger, all internal sources will be disconnected. In this mode the trigger point symbol (level and time position) will not be displayed, only the trigger time position will be indicated. External triggering requires a signal of 0.3 to 3  $V_{pp}$ , synchronous with the vertical input signal(s).

Triggering will also be possible within limits with multiples or fractions of the vertical input signal frequency. As the trigger signal may have any polarity, it may happen that the vertical input signal will start with a negative slope in spite of having selected positive slope; slope selection refers now to the external trigger.

### Indication of triggered operation (TRIG'D LED)

Refer item [23] in "Controls and Readout". The LED labelled TRIG'D indicates triggered operation provided:

- Sufficient amplitude of the internal or external trigger signal.
- The trigger point symbol is not above or below the signal.

If these conditions are met the trigger comparator will output triggers to start the time base and to turn on the trigger indication. The trigger indicator is helpful for setting the trigger up, especially with low frequency signals (use normal trigger) and very short pulses.

The trigger indication will store and display triggers for 100 ms. With signals of very low rep rate the indicator will flash accordingly. If more than one signal period is shown on the screen the indicator will flash each period.

### Hold off time adjustment

Consult "Controls and Readout" HOR VAR [30] > Hold off time for specific information.

After the time base has deflected the trace from left to right, the trace will be blanked so the retrace is invisible. The next sweep will, however, not immediately start. Time is required to perform internal switching, so the next start is delayed for the so called hold off time, irrespective of the presence of triggers. The hold off time can be extended from its minimum by a factor

of 10:1. Manipulation of the hold off time and thus of the time for a complete sweep period from start to start can be useful e.g. when data packets are to be displayed. It may seem that such signals can not be triggered. The reason is that the possible start of a new sweep does not coincide with the start of a data packet, it may start anywhere, even before a data packet. By varying the hold off time, a stable display will be achieved by setting it so that the hold off ends just before the start of a data packet. This is also handy with burst signals or non periodic pulse trains.

A signal may be corrupted by noise or hf interference so a double display will appear. Sometimes varying the trigger level cannot prevent the double display but will only affect the apparent time relationship between two signals. Here the variable hold off time will help to arrive at a single display.

Sometimes a double display will appear when a pulse signal contains pulses of slightly differing height requiring delicate trigger level adjustment. Also here increasing the hold off time will help.

Whenever the hold off time has been increased it should reset to its minimum for other measurements, otherwise the brightness will suffer as the sweep rep rate will not be maximum. The following pictures demonstrate the function of the hold off:

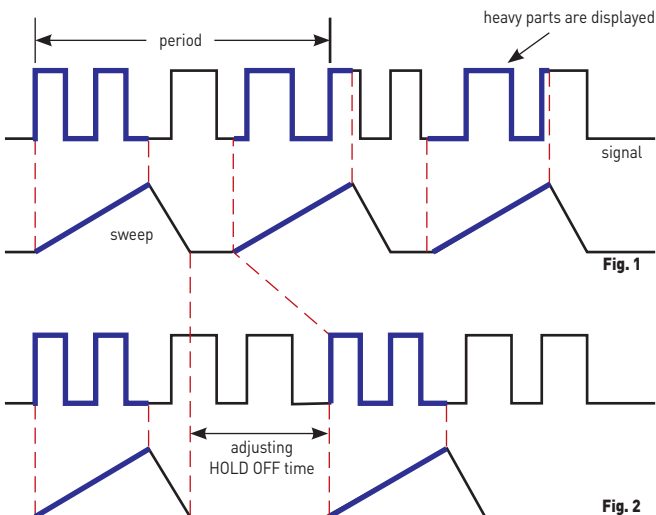

**Fig. 1: Display with minimum hold off time (basic setting). Double image, no stable display.**

**Fig. 2: By increasing the hold off a stable display is achieved.**

### Time base B (2<sup>nd</sup> time base). Delaying, Delayed Sweep. Analog mode

Consult "Controls and Readout" HOR VAR [30](#) and TIME/DIV. [28](#) for specific information.

As was described in "Triggering and time base" a trigger will start the time base. While waiting for a trigger, after completion of the hold off time, the trace will remain blanked. A trigger will cause trace unblanking and the sweep ramp which deflects the trace from left to right with the speed set with TIME/DIV. At the end of the sweep the trace will be blanked again and reset to the start position. During a sweep the trace will also be deflected vertically by the input signal. In fact the input signal does continuously deflect the trace vertically, but this will be only visible during the unblanking time. This is, by the way, one marked difference to digital operation where the input signal is only measured during the acquisition time, for most of the time the digital oscilloscope will not see the signal. Also, in analog

mode the signal itself will be seen on the screen in real time, whereas a digital oscilloscope can only show some time later a reconstruction of the signal acquired.

In analog mode the display will always start on the left. Let us assume one period of a signal is displayed at a convenient time base setting. Increasing the sweep speed with TIME/DIV. will expand the display from the start, so that parts of the signal will disappear from the screen. It is thus possible to expand the beginning of the signal period and show fine detail, but it is impossible to show such fine detail for "later" parts of the signal.

The x10 Magnifier (MAG x10) may be used to expand the display and the horizontal positioning control can shift any part of the display into the centre, but the factor of 10 is fixed.

The solution requires a second time base, called time base B.

In this mode time base A is called the delaying sweep and time base B the delayed sweep. The signal is first displayed by TB A alone. Then TB B is also turned on giving the mode "A intensified by B". TB B should always be set to a higher sweep rate than A, thus its sweep duration will be also shorter than that of A. The TB A sweep sawtooth is compared to a voltage which can be varied such that TB A functions as a precision time delay generator. Depending on the amplitude of the comparison voltage a signal is generated anywhere between sweep start and end.

In one of two operating modes this signal will start TB B immediately. The TB A display will be intensified for the duration of TB B, so that one sees which portion of the signal is covered by TB B. By varying the comparison voltage the start of TB B can be moved over the whole signal as it is displayed by TB A. Then the mode is switched to TB B. The signal portion thus selected is now displayed by TB B. This is called „B delayed by A“. Portions of the signal can thus be expanded enormously, however, the higher the speed of TB B the darker the display will become as the rep rate will remain that of the accepted signal triggers while the duration of TB B is reduced with increasing speed.

In cases where there is jitter the TB B can be switched to wait for a trigger rather than starting immediately. When a trigger arrives TB B will be started by it. The jitter is removed, however, the effect is also, that the TB B start now can be only from signal period to signal period, no continuous adjustment is possible in this mode.

### Alternate sweep

In this mode the signal is displayed twice, with both time bases. An artificial Y offset can be added in order to separate the two displays on the screen. The operation is analogous to Y dual trace alternate mode, i.e., the signal is alternately displayed by both time bases, not simultaneously which is not possible with a single gun crt. TB B operation is the same here.

## AUTOSET

For specific information consult "Controls and Readout" AUTOSET (11).

The following description is valid for both analog and digital mode. AUTOSET does not change from analog to digital mode or vice versa. If in digital mode the modes "Roll", "Envelope" or "Average" (ACQUIRE) are present or the trigger mode "Single" (MODE) is selected, these modes will be switched off as AUTOSET always switches to "Refresh" acquisition. The signal to be displayed must meet the amplitude and frequency requirements of automatic triggering, to enable a useful automatic instrument setting.

All controls except for the POWER switch are electronically scanned, all functions can also be controlled by the microcomputer, i.e. also via the interfaces.

This is a precondition for AUTOSET as this function must be able to control all functions independent of control settings. With the exception of FFT, AUTOSET will always switch to YT mode, but preserve the previous selection of CH1, CH2 or dual trace; ADD or XY modes will be switched to dual trace Yt.

AUTOSET helps in combination with FFT to avoid scaling problems and ensures that the signal height is within A/D converter limits.

Automatic setting of the vertical sensitivities and the time base will present a display within 6 cm height (4 cm per signal in dual trace) and about 2 signal periods. This is true for signals not differing too much from a 1:1 duty cycle. For signals containing several frequencies like video signals the display may vary.

Initiating the AUTOSET function will set the following operating conditions:

- last selection of ac or DC coupling
- internal triggering
- automatic triggering
- automatic trigger source selection
- trigger level set to the center of its range
- calibrated Y sensitivities
- calibrated time base
- AC or DC trigger coupling unmodified
- HF trigger coupling switched to DC
- LF or Noise Reject filters left
- X magnifier switched off
- Y and X positioning automatic

### Please note:

**For pulse signals with duty cycles approaching 400:1 no automatic signal display will be possible.**

In such cases switch to normal trigger mode and set the trigger position about 5 mm above the centre. If the trigger LED lights up, a trigger is generated and the time base is operating. In order to obtain a visible display it may be necessary to change the time base and V/DIV settings. Depending on the duty cycle and the frequency, the signal may still remain invisible. This applies only to analog mode. In digital mode the trace is always of equal brightness because not the actual signal is shown, but a low frequency construction of it. Also there is no stored information about the trace intensity.

## Component Tester

Specific information can be found in "Controls and Readout" under COMPONENT/PROBE (40) and COMPONENT TESTER (41).

The scope has a built in component tester. The test object is connected with 4 mm banana plugs. In this mode the Y amplifiers and the time base are turned off. If the components are part of a circuit this must be de energized and disconnected from safety ground. Except for the two test leads there must be no further connection between scope and component. (See "Tests within a circuit"). As described in section "Safety" all ground connections of the scope are connected to safety ground including those of the component tester. As long as individual components are tested this is of no consequence.

The display can only be affected by the controls contained in the FOCUS/TRACE menu: A-Int., Focus, Trace rotation, HORIZONTAL position.

If components are to be tested which are part of a circuit or an instrument they must first be de energized. If they are connected to the mains they must be unplugged. This will prevent a connection between scope and circuit via the safety ground which may affect the measurement.



### Do not test charged capacitors.

The principle of the test is very simple: a sine wave generator within the scope generates a 50 Hz  $\pm 10\%$  voltage which is applied to a series connection of the test object and a resistor within the scope. The sine wave proper deflects in X direction, the voltage across the resistor which is proportional to the test current deflects in Y direction.

If the object contains neither capacitors nor inductors, there will be no phase shift between voltage and current, so a straight line will show up which will be more or less slanted, depending on the value of the object's resistance, covering approx. 20  $\Omega$  to 4.7 k $\Omega$ . If there is a short circuit, the trace will be vertical, i.e. (almost) no voltage produces a high current. A horizontal line will thus indicate an open circuit: there is only voltage but no current.

Capacitors or inductors will create ellipses. The impedance may be calculated from the ellipse's geometric dimensions. Capacitors of approx. 0.1  $\mu\text{F}$  to 1000  $\mu\text{F}$  will be indicated.

- An ellipse with its longer axis horizontal indicates a high impedance (low capacitance or high inductance)
- An ellipse with its longer axis vertical will indicate a low impedance (high capacitance or low inductance)
- A slanted ellipse will indicate a lossy capacitor or inductor.

Semiconductors will show their diode characteristics, however, only 20 Vpp are available, so the forward and reverse characteristics can only be displayed up to 10 Vp in each direction. The test is a two terminal test, hence it is not possible to measure e.g. the current gain of a transistor. One can only test B-C, B-E, and C-E. The test current is only a few mA, so the test will not harm ordinary semiconductors. (Sensitive devices like delicate hf transistors etc. should not be tested). The limitation to 10 Vp with bipolar transistors will usually suffice as common defects will show up. The best method to verify whether a component is defective is comparison to a good one. If the lettering of a

component is not legible at least it is possible to see whether it is a npn or pnp transistor or which end of a diode is the cathode. Please note that reversing the test leads will also invert the picture, i.e. turn it 180 degrees.

In most cases, e.g. with service and repair, it will be sufficient to receive a good/bad result (open, short). With MOS components the usual precautions are to be observed, but note that except for a possible short MOSFETs and JFETs can not be sufficiently tested. Indications to be expected depend strongly on the kind of FET:

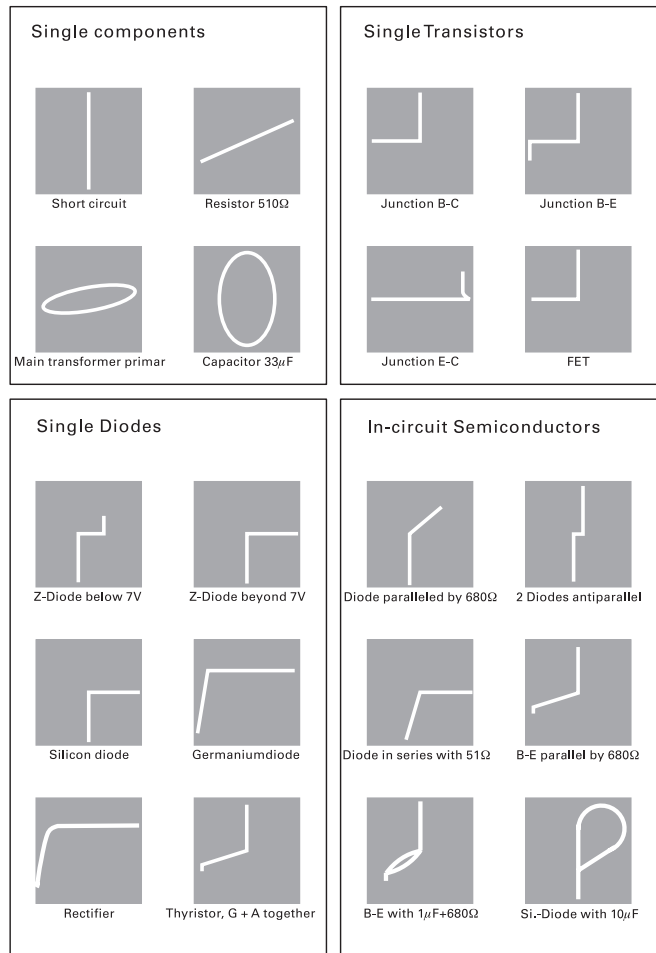
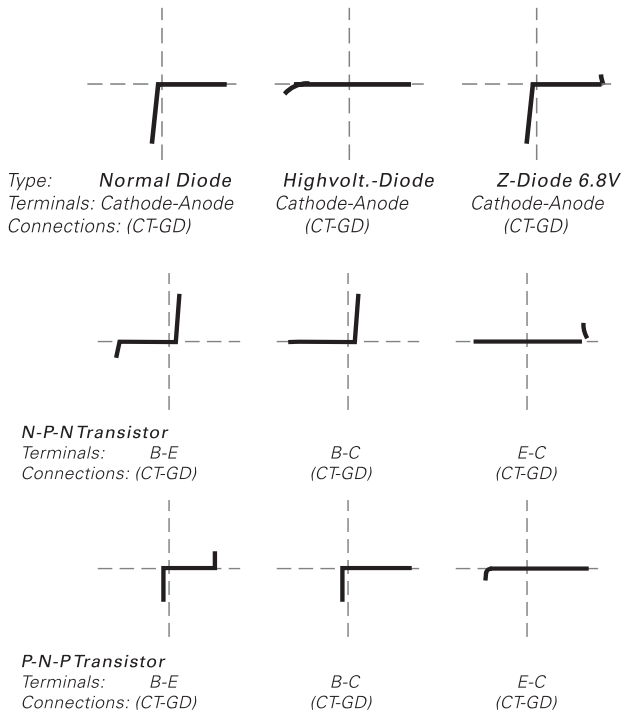

- With depletion type MOSFETs and all JFETs the channel will conduct if prior to testing, the gate was connected to the source. The  $R_{dson}$  will be shown. As this can be very low it may look like a plain short although the part is good!
- With enhancement type MOSFETs an open circuit will be seen in all directions, as the threshold voltage  $G - S$  is not available. With power MOSFETs the antiparallel diode  $S - D$  can be seen.

Tests of components within circuits are possible in many cases but less indicative because other components may be in parallel. But also here the comparison with a good circuit might help. Both circuits must be de energized and it is only necessary to switch the test leads back and forth between them in order to localize a defective spot. Sometimes, such as with stereo amplifiers, pushpull circuits, bridge circuits, there is a comparison circuit right on the same board. In cases of doubt one component lead can be unsoldered, the other one should then be connected to the ground lead. This is labelled with a ground symbol. The pictures show some practical examples:

## CombiScope®

The oscilloscope HM1008-2 combines two oscilloscopes in one: An analog oscilloscope and a digital oscilloscope. With a touch of the Analog/Digital pushbutton you can switch between analog and digital mode (oscilloscope operation). To avoid long explanations, the terms analog and digital mode are used in the following text.

HAMEG oscilloscopes are either analog or they are CombiScopes, i.e. they contain a complete analog scope and the additional hardware and software to sample, digitize, store, process and display the signals. The HM1008-2 is a 150 MHz 1 GSa/s CombiScope®.

With a HAMEG CombiScope® the user is always sure: he needs only to switch from digital to analog in order to see the true signal. This is especially important when a signal is to be documented in digital mode. The user of a pure digital oscilloscope needs to know the signal better than the scope!

### The advantages of digital operation are:

- Capture and storage of single events
- No flicker with very low frequency signals
- Fast signals with a low rep rate or low duty cycle can be displayed at high intensity
- Due to the storage of all signals they may be easily documented and processed.
- High quality crt's and custom electronic parts are used.

### The disadvantages of digital operation are:

- An analog scope displays the signal itself in real time. In a digital oscilloscope the signal is not displayed but only a low frequency reconstruction of the signal. The limitations and problems of sampling operation as well as those of analog/digital conversion hold. The display can not be in real time as, after capturing a signal, the digital oscilloscope must take a short time to perform calculations the result of which will then be displayed later.
- Therefore the capture rate of ordinary digital oscilloscopes is orders of magnitude lower than that of any analog scope. Hence a digital oscilloscope is least suited to catch rare events.
- There is no information in the trace, the trace is always of equal intensity. Thus valuable information (so called Z axis) is lost. Also the fast slopes of a pulse which are invisible on an analog scope will be of the same intensity as the slower parts of the signal, this is a gross misrepresentation. The reason is that digital oscilloscopes ordinarily do not show only the sampled points but they interpolate by drawing a continuous trace.
- The vertical resolution is mostly only 8 bits. In an analog scope there is no loss of fine detail by digitizing. Even if the trace is not very crisp details can be seen in it.
- Due to the sampling and the lack of a low pass filter in the input frequencies above half the sampling frequency will cause so called aliases, i.e. low frequency ghost signals. Sampling is practically the same as frequency conversion or multiplication, it creates sum and difference frequencies, beat frequencies which may be orders of magnitude lower

than the signal frequency and gives grossly erroneous results. In practice, therefore, only frequencies 1/10 or less of the sampling frequency can be reliably displayed. The meaning of the Nyquist theorem is mostly misunderstood: if the sampling frequency is only twice the signal frequency there will only be two points displayed on the screen: any number of signal shapes may be drawn which fit through these two points. The Nyquist theorem assumes that the signal is a sine wave. It is easily understood that, in order to depict an unknown signal shape one needs at least 1 or 2 points per centimeter; in other words: the useful signal frequency is only 1/10 to 1/20 at best.

- An analog scope has a frequency response which follows closely the Gaussian curve, this means in practice that also frequencies far beyond the -3 dB frequency will be shown, reduced in amplitude, but they will be shown. This not only preserves fine detail of a signal but it allows also to see, e.g., very high frequency wild oscillations in a circuit. This is not the case after sampling because all frequencies beyond half the sampling frequency will be „folded“ back into the lower frequency band.
- Due to limited memory depth the maximum sampling rate must be reduced in a digital oscilloscope when the time base is set to slow sweep speeds, it may be reduced from GSa/s to kSa/s! Most users are not aware of this drawback, they think that if they bought a digital oscilloscope with 100 MHz bandwidth and 1 GSa/s they are safe when measuring kHz range signals. But such low frequency signals may be distorted and possibly aliases displayed.

**Please note:** This list of disadvantages is by far incomplete! It only scratches the surface.

### There are 3 methods of sampling:

#### 1<sup>st</sup> Real time sampling

Here the Nyquist theorem must be observed, but, as mentioned, in practice the signal frequency is far less than 1/10 the sampling frequency. Consequently, with a 1 GSa/s rate signals with up to 100 MHz can be adequately reconstructed. Obviously, this is the only mode for single event capturing.

#### 2<sup>nd</sup> Equivalent time sampling

This is the normal operating mode for all sampling scopes. (Sampling scopes are very old, they are still the fastest scopes with bandwidths > 50 GHz because they have no input amplifier. Sampling scopes are far superior to digital oscilloscopes because their Y resolution is identical to that of an analog scope). In this mode consecutive periods of the signal are sampled, each period contributes but one sample. The signal period is thus scanned and very many periods are necessary in order to achieve one full screen display. This way a very high „effective“ sampling rate is achieved, this method exchanges bandwidth for time. In a sampling scope a very accurate display is created which is, as far as the shape is concerned, almost as good as that of an analog scope. In a digital oscilloscope, however, the sample points are 8 bit a/d converted, losing resolution. The bandwidth achieved is given alone by the hf properties of the input and the minimum realizable duration of the sampling pulse, so 14 GHz at a sensitivity of 2 mV/cm and 50 Ω was standard in the 1960's. In a digital oscilloscope, however, which should be used like an analog scope, a high impedance (1 MΩ) wide range (e.g. 1 mV/cm to 20 V/cm) attenuator must be included and also an input amplifier. This is why a digital oscilloscope cannot reach the bandwidths of sampling scopes. Equivalent time sampling suffers fully from the problems of aliasing. As it requires the (not necessarily periodic) repetition of the signal in

invariant shape for e.g. millions of periods, it is unsuitable for the capture of single events. Equivalent time sampling cannot display the rising portion of a signal without a delay line.

3. Random sampling:

Random sampling is also very old [1952] and not invented for digital oscilloscopes. It is similar to equivalent time sampling in that it requires a multitude of signal repetitions with invariant shape in order to reconstruct it once on the screen. Therefore also in this mode a very high „effective“ sampling rate is achieved. However, the samples are not taken step for step along the signal but randomly distributed over the signal period. An analog computer is used to estimate the arrival of the next trigger, and the time base is already started when it arrives. This has two enormous advantages:

- 1<sup>st</sup> The rising portion of the signal can be shown without the need for a delay line which would severely limit the achievable bandwidth.
- 2<sup>nd</sup> Due to the randomness of the samples alias signals will be broken up.

The foregoing explains why it is HAMEG policy to offer CombiScopes rather than pure digital oscilloscopes which combine the best of both worlds although the cost of such an instrument is markedly higher than that of a pure digital oscilloscopes, consider the complicated high frequency crt alone. It is the low cost of manufacturing which causes the drive towards digital oscilloscopes.

Digital operation

The 150 MHz scope has two 8 bit a/d converters of the flash type, the best there is. The maximum sample rate of each is 500 MSa/s which is the rate available in dual channel mode for the capture of single events. The maximum sampling rate in all other operating modes is 1 GSa/s.

Higher effective (!) sampling rates are possible as explained above in equivalent and random sampling modes. As very many signals repetitions are needed to reconstruct the signal once any changes in signal shape such as noise will show up.

The reconstructed signal may be displayed either by showing only the sampled points or with interpolation between them by drawing straight lines. The signals stored in digital mode can be read via an interface and documented. See the chapter "Data Transfer" for details.

Digital operating modes

In digital mode the following operating modes are available:

- 1. Menu: ACQUIRE: Repetitive triggered signal acquisition and display in usual Yt representation.  
  
 REFRESH: readout shows "rfr" (real time sampling) or  
 Random sampling: readout "RS:xGSa".  
  
 The operating mode may be further subdivided:  
 Envelope: readout "env"  
 Average: readout "avg:x"  
 (x may be a number 2.. 512)
- 2. ROLL mode, untriggered continuous signal acquisition, display will „roll“ over the screen from left to right in usual Yt mode:  
 Roll: readout "rol"

- 3. Single sweep, triggered (menu: Trigger MODE) signal capture in usual Yt mode:  
 Single: readout "sgl"
- 4. Untriggered continuous signal capture, display in XY mode (Menu: trigger MODE):  
 XY: readout "XY"
- 5. XY display of signals which were previously captured in Yt mode and protected against overwriting by STOP:  
 XY: readout "XY"

Signal capture is triggered in SINGLE, REFRESH, ENVELOPE, and AVERAGE modes and untriggered in ROLL and XY modes.

The normal (Refresh) mode is similar to the operating mode of an analog scope. Triggering will cause signal acquisition and display from left to right. After the next acquisition the display will be replaced by the new information. If automatic triggering was selected there will be a reference trace in the absence of a signal the position of which is dependent on the vertical position control setting. Signals with a repetition rate lower than the rep rate of the automatic triggering can not properly trigger so the resulting display will be untriggered.

In contrast to an analog scope the last display will remain on the screen if the signal disappears in normal trigger mode.

In SINGLE mode the signal will be acquired only once. Acquisition can start if STOP (RUN key) is not illuminated (if necessary press RUN until STOP extinguishes). The next trigger received will cause the single acquisition. After this STOP will light up and the trigger mode will be automatically switched to normal DC coupled if auto was selected.

The trigger symbol on the screen allows you to directly determine the voltage level desired for triggering in the normal mode, the voltage follows from the position and the VOLTS/cm selected. The ground reference will be indicated by a ground symbol in the screen centre.

After selecting SINGLE the trigger level symbol may be positioned using the LEVEL control. If e.g. the symbol is 2 cm above the ground reference symbol the trigger level will be 2 cm x Volts/cm (x probe factor if any).  
**Example:** 2 cm x 1 V/cm x 10 (probe) = + 20 V.

Memory resolution

Vertical resolution:

The 8 bit a/d converters have a resolution of 256 possible vertical positions. The screen display has a resolution of 25 points per cm. This is advantageous for display, documentation and post processing.

There may be some difference between the display on screen and documentation, e.g. on a printer, this results from various tolerances in the analog circuitry involved. The trace positions are defined by:

Median horizontal line:	10000000b	80h	128d
Top line:	11100100b	E4h	228d
Bottom line:	00011100b	1Ch	28d

In contrast to an analog display with its theoretically infinite resolution this is limited to 25 points per cm in digital mode. If there is any noise superimposed on the signal this may cause frequent change of the lowest bit and thus jumping of the trace in vertical direction.

**Horizontal resolution:**

A maximum of 4 simultaneous signal displays may be shown on the screen. Each signal display will consist of 2048 points (bytes). 2000 points will be distributed over 10 cm. The resolution is thus 200 points per cm. Please note that this is a 4 to 8 times improvement over customary VGA (50 points per div) or LCD (25 points per div.) DSO displays.

**Memory depth**

1 GS/s means that one million samples of the signal will be taken and stored. With normal triggering and time base settings of >20 ms/cm there will be 500,000 samples.

The screen display is calculated from the whole memory contents. Within the menu Settings > Display several display modes may be selected:

- Dots: the sampling points only are displayed.
- Vectors: interpolation (sin x/x) or dot join is used to generate a continuous trace.
- Optimal: In this mode all samples are used to calculate the display. This way the display of aliases is less likely.

The scope acquires with the highest sampling rate possible thus preventing to a large extent the production of alias signals. It is always possible to zoom through the memory in order to look at details, and, thanks to the deep memory, signal details may be shown which remain invisible with shorter memory digital oscilloscopes.

**Example:**

This scope will sample with 1 GSa/s in single channel mode down to a time base setting of 100 us/cm. This equals 100,000 points per cm. In MEMORY ZOOM signals of 150 MHz can still be seen. Down to 100 us/cm hence aliases are not to be expected due to the bandwidth limit of 150 MHz and the critical frequency being > 500 MHz.

Digital oscilloscopes with a shorter memory like e.g. 10 K will only present 1000 points per cm which is equivalent to a sampling rate of 10 MHz, thus signals → 5 MHz will cause aliases, far below the scope bandwidth. A deep memory is one of the most important criteria of a digital oscilloscope.

**Horizontal resolution with X magnifier**

In principle, with a 10 x magnified sweep, the resolution should be reduced to 20 points per cm. However, the resolution remains at 200 points per cm as the information necessary will be calculated from the memory. The magnified portion may be selected with the X POS control. The fastest time base will be 5 ns/cm allowing 2 cm per period display of 100 MHz.

**Maximum signal frequency in digital mode**

The highest signal repetition frequency which still can be displayed well cannot be given exactly. This is dependent on the signal shape as well as on its amplitude displayed.

While it is fairly easy to recognize a square wave, it requires at least 10 samples per period to distinguish a sine wave from a triangle. In other words, in practice, signals may still be recognized if their repetition frequency is <1/10 of the sampling frequency. For a well defined display, however, many more than 10 points per cm are necessary.

**Display of aliases**

As explained the maximum sampling rate must be reduced for slow time base settings. This may cause aliases. If e.g. a sine wave is sampled only with one sample per period and if it should be synchronous with the sampling frequency a horizontal line will be shown as each time the same signal point is sampled. An alias may also take the form of a signal of much lower frequency (beat frequency between signal and sampling frequencies), apparently untriggered changing displays, or may look like AM modulated signals. If an alias is suspected, change the signal frequency or the time base or both. If aliases remain undetected grossly erroneous results will be obtained which includes also grossly (maybe orders of magnitude) false displays of signal parameters like rise time etc.! Always watch for a stepped display or printout: this indicates an insufficient sampling rate and consequently a false display. With an insufficient sampling rate e.g. fast, short pulses may be completely ignored.

The best method to detect any false digital oscilloscope display is to switch to analog mode. In analog mode false displays are absolutely impossible! An analog scope can at worst round the edges of very fast signals.

**Vertical amplifier operating modes**

In principle, in digital mode there are the same modes available as in analog mode, i.e.:

- CH1 only
- CH2 only
- CH1 and CH2 in dual trace mode Yt or XY
- Sum
- Difference

**The main differences of digital mode are:**

- In dual channel mode both channels and signals are a/d converted simultaneously.  
No alternate or chopped channel switching.
- No flickering display even with low frequency signals as the signals are stored and continuously displayed from the memory with a sufficiently high rep rate.
- Trace intensity is always the same. This can be an advantage and a disadvantage.

All so called Z axis (trace intensity) information is lost. In analog mode the intensity depends on the signal rep rate and the speed, thus mixed or unstable signals can be differentiated by their respective trace intensity. Fast slopes of low frequency signals are invisible in analog mode, in digital mode they will be shown as bright as the other signal portions.

## Data transfer

The oscilloscope has three interfaces.

1. On the front panel below the CRT is a USB flash drive connector. Further information can be found under „Controls and Readout“.
2. The following information is regarding the interface HO720 located at the rear panel of the oscilloscope in top right position. It contains the following bidirectional interfaces for data transfer between oscilloscope and PC:
  - USB (Device)
  - RS-232

The interface is identified by the oscilloscope firmware and indicated in some menus. If required the interface HO720 can be exchanged for another interface.



**Safety hints:**  
All interface connections are galvanically connected to the scope.

Measurements at high potentials are prohibited and endanger the scope, the interface and all equipment connected to the interface.



**Warning!**  
The installation or exchange of an interface may take place only if the device was switched off previously and was separated from mains/line.

If the safety rules are disregarded any damage to HAMEG products will void the warranty. Neither will HAMEG take any responsibility for damages to people or equipment of other makes.

## Description

### USB (Device)

The CD added to the oscilloscope contains a folder with the name of this oscilloscope. Amongst others it contains the folder HO720\_D2xx\_DriverVxxx, where „Driver“, „Tools“ and a description for USB driver installation can be found.

To enable a communication between PC and oscilloscope, an USB driver must be installed on the PC, which is requested by Windows if for the first time a connection is made between oscilloscope and PC via USB. A direct connection from the PC`s USB connector to the oscilloscope USB interface requires a screened USB cable with less than 3 m length. The CD contains other information under „HO720 description and USB driver installation ...“

„Tools“ contains the folder „FT Clean“ with a program for USB driver installation and „USB Install Test“ a program for USB connection test.

### RS-232

The RS232 interface has the usual 9 pole Sub D connector. Via this bidirectional interface the scope can be controlled remotely or its settings may be transferred. In digital mode also the digitized and stored signals can be read out. The connection with a PC requires a 9 pole screened cable (1:1) with less than 3 m length. The pin out is as follows:

### Pin

#### no. Function

- |   |  |
|---|--|
| 2 | Tx data from scope to external device                        |
| 3 | Rx data from external device to scope                        |
| 7 | CTS ready to transmit  |
| 8 | RTS ready to receive   |
| 5 | ground (scope is connected to safety ground, safety class I) |
| 9 | + 5 V, max. 400 mA   |

The maximum signal on Tx, Rx, RTS and CTS is  $\pm 12$  V. The RS-232 interface parameters are:  
N-8-2 no parity, 8 bits data, 2 stop bits (RTS/CTS hardware protocol). These parameters can be set on the oscilloscope.

### Loading of new oscilloscope firmware

The most recent firmware is available for down loading is available at [www.hameg.com](http://www.hameg.com).

### Note:

A firmware update may cause changes in operation and new functions. In such cases an updated manual can be download from the HAMEG homepage.

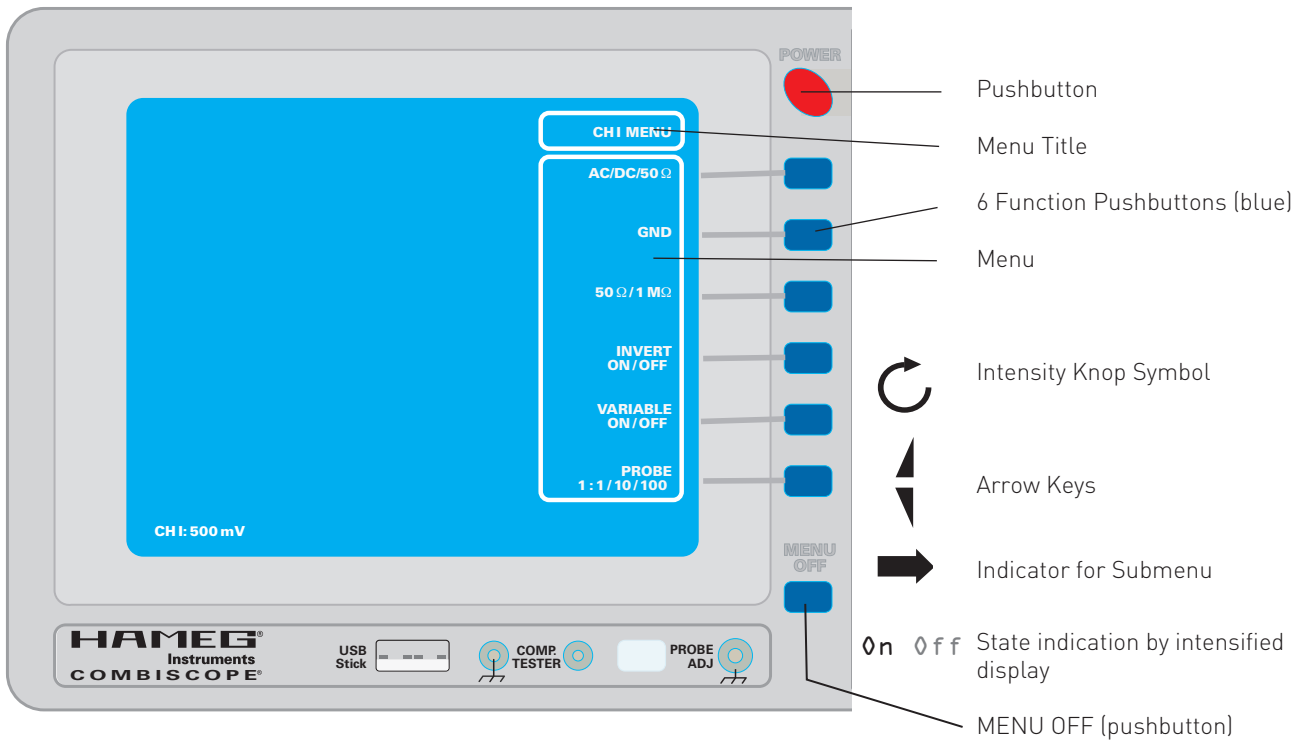

## General information concerning MENU

### Menu and HELP displays

In most cases a menu is displayed after pressing a pushbutton. It contains several menu items assigned to the blue function pushbuttons. Pressing a function button switches over, on or off.

Exiting a menu:

- 1<sup>st</sup> Automatically after a user defined time (SETTINGS **10**) pushbutton >, Misc > Menu OFF > time in seconds) elapsed.
- 2<sup>nd</sup> By pressing the MENU OFF **43** pushbutton.
- 3<sup>th</sup> Pressing the SETTINGS **10** pushbutton to switch back in the menu hierarchy.
- 4<sup>th</sup> Pressing another pushbutton.

With some menu items a rotary knob symbol is displayed pertaining to the INTENS knob **2** which then can be used to change settings. Also arrows may be shown which point to available submenus.

In some modes various pushbuttons or INTENS operations are meaningless and will hence not cause a menu display.



**Please note:**

**If a menu is shown some other information displayed in the readout may disappear, this will reappear immediately upon leaving the menu.**

Each menu is assisted by HELP texts, which can be called by pressing the HELP **12** and which will be also displayed by the readout. If HELP was called and the INTENS knob **2** moved an

explanation of the actual INTENS knob **2** function will be given. HELP will be left by pressing the pushbutton again.



**Please note:**

**During the display of help texts and menus in full size no signal display is possible.**

### Remarks

In operation all relevant measuring parameters will be shown in the readout, provided the readout was activated and its intensity is sufficient.

The front panel LEDs add to the operating comfort and give more information. In the end positions of the control knob an acoustical signal will sound.

Apart from the POWER **1** pushbutton, all control elements are scanned and stored. This allows you to control the instrument from stored information. Some controls and menus are only operative in digital mode or change their meaning in this mode. Explanations are given with the warning: "Only in digital mode."

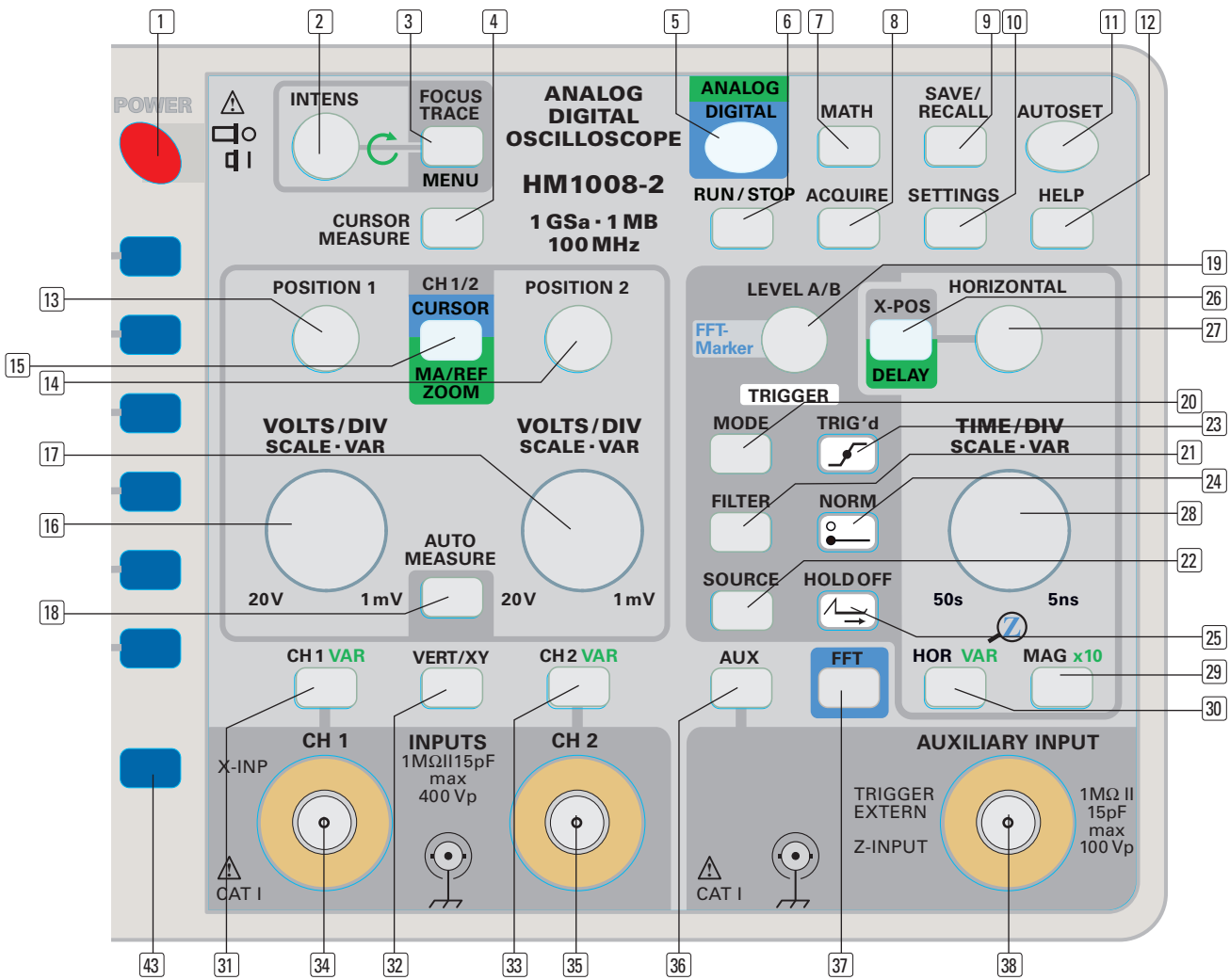

## Controls and Readout

### 1 POWER (pushbutton)

Mains switch with symbols I = ON and O = OFF.

After turning the scope on and the warm up time of the crt heater has elapsed, the HAMEG logo, the instrument type and the version number are displayed. If prior to switching off the function "Quick Start" was selected (SETTINGS (10) > Misc) the above will not be displayed. Then the scope will assume the settings which existed before switching off.

### 2 INTENS (knob)

This knob controls various functions:

**2.1** Trace intensity (signal display) if the FOCUS/TRACE/MENU pushbutton (3) does not light or blink. Turn left for decreasing and right for increasing.

**2.2** If the FOCUS/TRACE/MENU pushbutton (3) lit the control will act for those functions displayed in the menu, which were activated.

### 3 FOCUS TRACE MENU (pushbutton)

Pressing this pushbutton calls the "Int. Knob" menu and the pushbutton is constantly lit. Then the INTENS knob (2) function can be determined by selecting a menu item.

Depending on the operating mode the menu contains:

**A-Int.:** Intensity of the signal as displayed by time base A

**B-Int.:** Intensity of the signal as displayed by time base B

**Zoom-Int.:** Intensity of the signal expanded by Zoom

**RO Int.:** Readout intensity

**Focus:** Focus for signal and readout

**Readout On Off:** The readout can be switched off to eliminate interference of the readout with the signal(s), that may occur in analog mode. After Readout Off has been chosen, press the MENU OFF pushbutton (43) to leave the menu. Thereafter only the signal display is activated and the FOCUS TRACE MENU pushbutton will blink as long as the readout is off. Pressing the flashing pushbutton calls the Int. Knob menu where the readout function can be switched on again. After switching the instrument on, the readout is always present. The readout is regarding the parameter, menu and help text display.

**Trace rotation:** Trace rotation (see TR)

**4** CURSOR MEASURE (pushbutton)

On condition the cursors have been switched off, pressing the CURSOR MEASURE pushbutton switches the cursors and the cursor measurement results on. If the cursors and the measurement results are displayed, pressing the CURSOR MEASURE pushbutton again then causes the display of the "Cursors" menu and its selection box. Additionally the FOCUS TRACE MENU pushbutton **3** lights, indicating that the INTENS knob **2** has a function allocated to the selected item of the "Cursors" menu.



**Note:**  
CURSOR MEASURE can not be called when FFT mode is present.

Depending on the mode (Yt or XY, analog or digital mode) different cursor measure functions can be chosen in this menu, regarding the cursor lines and their direction.

The cursor lines and the measurement result are displayed after the "Cursors" menu is switched off by pressing the MENU OFF pushbutton **43**. The results of cursor measurements will be displayed by the readout in the top right corner of the screen. (e.g.  $\Delta V(\text{CH}2): 16.6 \text{ mV}$ ). If a variable control was activated, the readout will indicate this by replacing the ":" by a ">".

**Cursor positioning**

The cursor lines and symbols can be moved by POSITION 1 **13** and POSITION 2 **14** knobs after being activated as cursor controls. The POSITION knob function can be selected in the "Pos./Scale" menu which can be called by pressing the CH1/2-CURSOR-MA/REF-ZOOM pushbutton **15**. In this menu the selection of "Cursors" (long lines) or "Aux Cursors" (short lines) or other symbols will determine which cursor lines/symbols can be moved by the POSITION 1 and 2 controls.

**Menu items**

Depending on the operating mode (Analog, Digital, Yt or XY) this menu will offer various cursor measuring functions which will also affect the cursor lines and their position. The function key "Off" switches the cursors off, cause the "CURSORS" menu to be left and switches the cursor measuring result display in the readout off.

**4.1 Meas.(uring) Type**

If this function is activated, the INTENS knob **2** can be used for measurement selection. In most cases the corresponding unit will be automatically displayed. The measuring modes are self explaining.

**4.2 Unit**

In the modes "Ratio X" and "Ratio Y" the INTENS knob symbol  will be shown in addition to a unit, this may then be used to change the unit.

**4.2.1**

In the modes "Ratio X", "Ratio Y" and "Count" the INTENS knob symbol  will be shown in addition to a unit, this may then be used to change the unit.

**4.2.1.1 "rat" (ratio), display of ratios**

In this mode the ratios of duty cycles or amplitudes may be determined with the CURSORS. The distance between the long CURSOR lines is equal to 1.

**4.2.1.2 "%" (percent), display of percentages**

The distance between the long CURSOR lines is equal to 100%. The result will be determined by the distance of the short auxiliary cursor line to the long reference line (lower respectively left), if appropriate with a negative sign.

**4.2.1.3 "°" (degree), measurement of degrees**

The distance between the long CURSOR lines is equal to 360 degrees and must be exactly as long as a signal period. The measurement result will be determined from the distance between the reference line to the short auxiliary cursor line. If appropriate with a negative sign. For further information please consult "Measurements of phase differences in dual channel mode (Yt)" in the section "First time operation and pre settings".

**4.2.1.4 "π"**

One period of a sine wave is equal to  $2\pi$ , hence the distance between the two long CURSOR lines must be set to one period. If the distance between the reference line and the short CURSOR line equals 1.5 periods, " $3\pi$ " will be displayed. If the short cursor line is left of the reference line a negative sign will be shown.

**4.2.2** In combination with the measuring mode "Count" the INTENS knob symbol  is displayed additionally to the unit, indicating that it can be determined by the user.

**4.2.2.1 "positive Puls"**

The number of such pulses, that are located between the vertical cursor lines and crossing the horizontal auxiliary cursor line, are displayed.

**4.2.2.2 "negative Puls"**

The number of such pulses, that are located between the vertical cursor lines and crossing the horizontal auxiliary cursor line, are displayed.

**4.2.2.3 "rising edge"**

The number of rising edges, that are located between the vertical cursor lines and crossing the horizontal auxiliary cursor line, are displayed.

**4.2.2.4 "falling edge"**

The number of falling edges, that are located between the vertical cursor lines and crossing the horizontal auxiliary cursor line, are displayed.

**4.3 Respect**

It may be necessary to determine for which signal channel the CURSOR measurement shall be valid. This is indicated by showing the INTENS knob symbol  next to the channel number. After selection of the signal source, the CURSOR lines must then be positioned to the signal or portions of it displayed by this channel.

**4.4 Off (Cursors Off)**

Pressing the function key "Off" switches the "Cursors" menu, the cursor lines and the cursor measurement results off.

If only the "Cursors" menu displayed shall be switched off, press the MENU OFF pushbutton **43**.

**5** ANALOG/DIGITAL (pushbutton)

The color in which the pushbutton lights, indicates the operating mode (analog= green, digital = blue). In case of Yt or XY mode no settings are affected by switch over. As FFT is only available in digital mode, it is switched off after switch over to analog mode and the last used Yt mode is present. If COMPONENT TEST mode is present (analog mode), switching over to digital mode automatically switches over to the last used mode (Yt or XY).

Y parameters will not be changed by switching. Time base modes will be changed due to the different operation of the time bases in both modes. After any switching, time base A will be

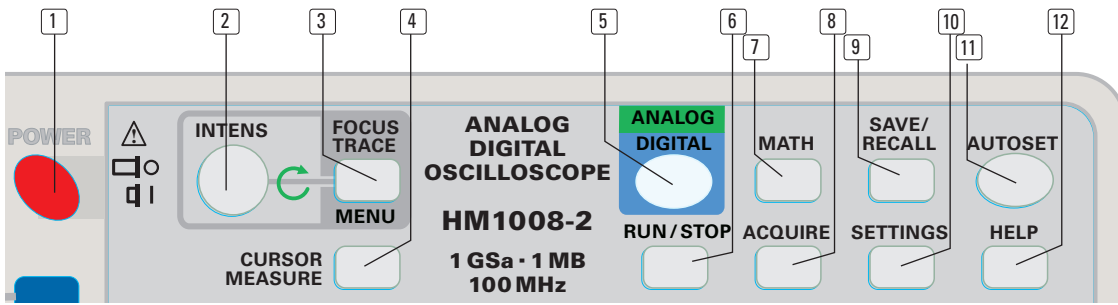

selected. The time base speeds selected will not be affected unless they are not available any more, then the maximum value will be chosen.

**6** RUN/STOP (pushbutton)

This pushbutton has several functions:

**6.1 Analog mode, single event capture**

The RUN/STOP pushbutton concerns the display of so called one time events. To prepare the instrument for this, call the "Trigger" menu by pressing the MODE pushbutton (20) and activate „Single“. Pressing the RUN/STOP pushbutton thereafter activates the trigger unit. Then the pushbutton blinks until a signal has triggered the timebase and a sweep has been completed. The completion is indicated by the constantly lit RUN/STOP pushbutton. Pressing the pushbutton again prepares for the next event capture, indicated by the pushbutton blinking again.

Depending on the time base setting the trace deflection speed may be so high that the trace cannot be seen and only a photo can make it visible.

**6.2 Digital mode**

**6.2.1 Single event capture**

The RUN/STOP pushbutton concerns the display of so called one time events. To prepare the instrument for this, call the "Trigger" menu by pressing the MODE pushbutton (20) and activate „Single“. Pressing the RUN/STOP pushbutton thereafter activates the trigger unit, indicated by the flashing pushbutton.

In contrast to analog mode the signal capture starts at once without waiting for a trigger event. After an event has triggered and the post trigger time elapsed, the capture stops. Thereafter the RUN/STOP pushbutton is constantly lit and the signal is displayed without change to be stored or evaluated.

Pressing the RUN/STOP pushbutton again, starts a new capture that overwrites the previous event and the pushbutton blinks.

If the single event capture mode shall be finished, the MODE pushbutton (20) must be pressed and then "Auto" or "Normal" triggering must be chosen.

**6.2.2 Finishing or interrupting signal updating.**

The RUN/STOP pushbutton can also be used without single event capture mode. Pressing once stops the current signal capture (RUN/STOP light) and pressing again starts it again (RUN/STOP not lit).

**7** MATH (pushbutton)

[digital mode only, not in FFT mode.]

The MATH pushbutton calls the "Mathematics" menu and a formula editor. The mathematic menu enables the mathematical

processing of current channel 1 and 2 signals. The results may be graphically displayed on the screen and determined by the AUTO and CURSOR MEASURE functions. All entries and settings will be automatically stored upon leaving the Mathematics menu or turning the scope off. Measurement results will be lost after turn off. "Mathematics" offers:

**7.1 Equations set**

Using the INTENS knob (2) five sets of formulas can be selected for editing. This way 5 user defined formula sets may be created.

Each set of formulas consists of 5 lines with one equation each, designated MA1 to MA5. An equation may occupy one or more lines. In this case it must be kept in mind that the lines of equations are processed as a stack, i.e. starting with MA1 = 1<sup>st</sup> line, to MA5 = 5<sup>th</sup> line.



**Please note:**

The valid formula set is that shown prior to leaving the MATH menu.

**7.2 Edit**

"Edit" opens the "Mathematics Edit" submenu.

**7.2.1 Equation.**

5 equations may be selected with the INTENS knob. Each equation consists of the name of a result (e.g. MA5), the = sign, the function (e.g. ADD) and (first operand, second operand). Remark: The second operand will not be displayed with all functions (e.g. SQ).

**7.2.2 Function.**

By using the INTENS knob, the following functions may be selected:

- ADD: Operand 1 + operand 2
- SUB: Operand 1 – operand 2
- MUL: Operand 1 times operand 2.
- DIV: Operand 1 divided by operand 2.
- SQ: Operand 1 squared.
- INV: Changes sign of operand 1.
- 1/: Calculates 1/operand 1 (reciprocal value).
- ABS: Takes absolute value of operand 1 (removes sign)
- POS: Only values of operand 1 > 0 are displayed, < 0 will not be displayed.
- NEG: Only values of operand 1 < 0 are displayed, > 0 will not be displayed.

**7.2.3 Operand 1**

The INTENS knob allows the selection of these signals as operands:

- CH1 = current channel 1 signal
- CH2 = current channel 2 signal
- MA1 = result of equation MA1
- MA2 = result of equation MA2
- MA3 = result of equation MA3
- MA4 = result of equation MA4
- MA5 = result of equation MA5



After MA the next step causes an arrow symbol to be displayed in the "Mathematics Edit" menu under item "Edit". It is a hint about another submenu described under item 7.2.5.

#### 7.2.4 Operand 2

This operand can only be chosen if the function ADD(ition), SUB(traction), MUL(tiplication) or DIV(ision) is present. Then the same signals can be chosen as described under item 7.2.3.

After MA the next step causes an arrow symbol to be displayed in the "Mathematics Edit" menu under item "Edit". It is a hint about another submenu described under item 7.2.5.

#### 7.2.5 Operand selection by Constant Editor

In the CW position of the INTENS knob  an additional item "Edit" and an arrow symbol is displayed. Pressing the associated function button opens the sub submenu "Edit Edit". This allows you to choose a number, its "Dec.Point" (decimal point) and its "Prefix" of the "Unit", all with the INTENS knob . The unit need not be selected : it is only shown as a reminder.

### 7.3 Display



#### Attention!

**"Mathematics signals" and "Reference signals" cannot be displayed at the same time. Displaying "Mathematics signals" automatically switches the display of "Reference signals" off and vice versa.**

The function "Display" is available twice in the menu and may be switched on or off in any combination. This allows you to display: no result, one result, or the result of two equations as signals. The displays will come forward upon leaving the "Mathematics" menu. Also the designation of the equation (e.g. MA2) will be shown. Select the equations to be displayed with the INTENS knob .

The mathematics signal is automatically scaled, this is independent of the graticule, of Y and time base parameters, hence the scale will not be shown. The measurement of the signal amplitudes must be performed with AUTO MEASURE or using the CURSOR (V to GND) after the "reference" (e.g. MA2) of the CURSOR to the "mathematics signal" and its scale is established (CURSOR MEASURE pushbutton > Cursors > reference > e.g. MA2). The readout may then display e.g.: "V(MA2): 900 mV".

In combination division and the constant 0, no result will be displayed. The mathematics function will only be calculated and displayed if possible. As the calculation is made in real time conditions, a new calculation requires that the channels are activated and new valid data are present (e.g. trigger conditions are met). An error message will not be output.

#### 7.4 Units

Each function "Display" will be associated with a function "Unit" which can be selected with INTENS knob  and will be attached to the result.

#### Acquire (pushbutton)

Digital mode only, in FFT mode without effect

This pushbutton opens the menu ACQUIRE which offers these modes:

#### 8.1 Normal (Refresh) – Capture/Display

In this mode repetitive signals can be recorded and displayed, as in analog mode; the display shows rfr. The current signal capture can be stopped (pushbutton lit) or started (pushbutton not lit) by the RUN/STOP pushbutton .

A trigger will start a new acquisition which will overwrite the display of the former. The display will remain on screen until the next acquisition. This mode is available over the full time base range (50 s/cm to 5 ns/cm).



#### Please note:

**At 20 ms and smaller time deflection coefficients the signal display always starts at the screen left. After switching to a time deflection coefficient of 50 ms or higher, the capture starts at once but under these conditions the signal display starts at the trigger point, which is placed without delay (Readout: "Tt:0s") at the screen horizontal center. The second capture starts at the screen left.**

This behaviour is relatively meaningless for small time deflection coefficients. In the case of high time deflection coefficients combined with high Post Trigger times, the instrument seems to show no reaction. The resulting uncertainty can be avoided by activating the "Status" display (see item 10.4.4 Status Erf. AUTO AUS).

The following example describes the long waiting times caused by the 1 M Byte RAM:

With the time base setting at 50 s/cm and the trigger point set to the utmost left position by the HORIZONTAL control , the readout will indicate "Tt:1.85ks". This means that 1,600 seconds must elapse until the trace will become visible at the screen left and after another 250 s it will have reached the screen centre (1,600 s + 250 s = 1.85 ks).

After the capture has been completed, the new signal curve overwrites that previously recorded, after a trigger event started the capture and the waiting time elapsed.

#### 8.2 Envelope capture/display

Envelope is a special refresh mode, the readout will show "env". Also in this mode there must be sufficient signal for triggering.

In contrast to the refresh mode the results of several captures will be examined and the maxima and minima stored, the envelope of the signal will then be displayed if it changes in amplitude or/and frequency. Also any jitter will be shown.

Also in this mode pressing RUN/STOP  will stop the acquisition, indicated by STOP constantly lit. After pressing the pushbutton again, the formerly stored signals will be erased and the envelope calculation starts anew. In order to prevent an accidental turning on of this mode, operating any control which influences the signal display will automatically switch envelope off.

Because this mode requires many signal repetitions and acquisitions it is not compatible with single sweep/acquisition. AUTO or normal trigger modes must be selected.

#### 8.3 Average mode capture/display

This is also a special mode within the refresh mode. Also here signal repetitions are needed.

The weighting of each acquisition can be selected with "Average" in the menu, any number between 2 and 512 may be chosen using the INTENS knob . The readout will show e.g. "avg#512".

The higher the number of acquisitions averaged, the lower the contribution of a single acquisition will be and the longer the

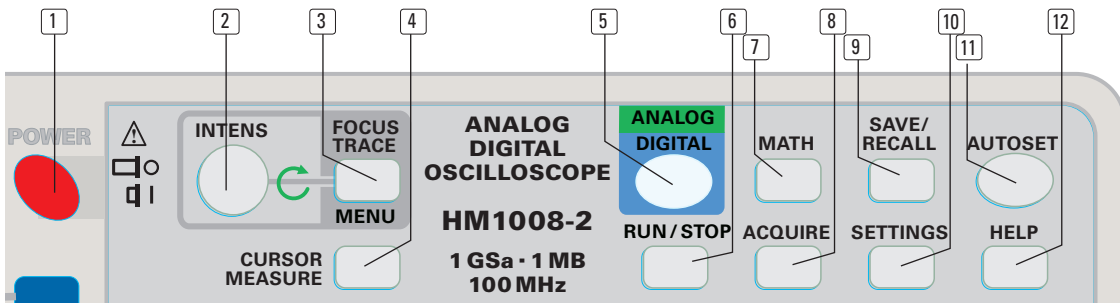

averaging will take. Averaging is a means to increase the accuracy in spite of the 8 bit converters, it is an exchange of time against accuracy. Noise will be reduced by averaging.

The same holds as for envelope: the acquisition may be stopped by pressing the RUN/STOP pushbutton, STOP will be illuminated. Pressing RUN/STOP again will restart. In order to prevent an inadvertent entering of this mode the operation of any control will automatically cause this mode to be reset.

The average mode capture can be stopped by the RUN/STOP pushbutton (6) which will constantly light. Pressing the RUN/STOP pushbutton (6) again resets the previous signal display, starts a new average capture and the pushbutton becomes unlit. To prevent erroneous signal display, the use of controls that influence the signal display automatically cause a reset and a new start of the acquisition.

As repetitive acquisitions are needed for calculation of an average, single sweep will not be compatible.

**8.4 Roll mode capture/display**

Roll mode means that the signal(s) will be continuously acquired without the need for a trigger. Hence all controls, displays and readouts for the trigger and ZOOM will be disabled. The readout will show "rol".

The result of the last acquisition will be displayed at the right hand edge of the graticule, all formerly acquired signals will be shifted one address to the left. The result at the left hand screen edge will be dropped. There is no waiting for a trigger and thus the hold off time is minimum. As in any other mode the signal acquisition may be stopped and restarted any time with the RUN/STOP pushbutton.

In roll mode the time base available is limited to 50 s/cm to 50 ms/cm. Faster time bases do not make sense as the signal could not be observed any more. Where the time base was set outside the limits, it will be automatically changed to the next value within the limits upon entering this mode.

If a time deflection coefficient between 20 ms/cm and 5 ns/cm is present and "rol" mode is chosen, the time base will be set automatically to 50 ms/cm.

**8.5 Peak Detect Auto Off**

If (Peak Detect) "Auto" is present, this way of signal capture will be automatically switched on if Yt (time base) mode is present, in combination with time deflection coefficients from 50 s/cm to 500 ns/cm. This capture mode is available if refresh, roll, envelope, average and single (event) trigger is active. The readout then displays "PD:..." in front of the abbreviation for the signal capture mode.

Without Peak Detect activated, the signal sampling rate is relatively low at high time deflection coefficients. As a result there are wide time caps between the samples, and short signal deviations such as glitches may occur without being sampled.

The maximum gap size is 0.25 s between the samples at a time base setting of 50 s/cm.

The advantage of Peak Detect is that signals are sampled with the highest possible sampling rate to reduce the gap size, so that even signals with a pulse width of >10 ns can be recorded. This increases the number of signal data that must be evaluated so that only those samples are displayed with the highest deviation. Without glitches the deviation is caused by noise.

**8.6 Random Auto Off**

Provided single sweep was not selected, Random Sampling will be automatically selected beginning at a certain sweep speed. The time base setting will be indicated in the readout, e.g. "RS: 10 GSa" (= Random sampling with 10 GSa/s effective sampling rate), the real time, time base speed will be 5 ns/cm. Without Random Sampling "RS" Real Time Sampling will be used with a maximum sampling rate of 1 GSa/s (one channel only) or 500 kSa/s (two channel mode).

Random Sampling requires repetitive signals, each signal period will contribute one sample. At an effective sampling rate of 10 GSa/s the time difference from sample to sample along the signal period will be 0.1 ns. However, note that with random sampling the samples are not taken in sequence along the signal period but randomly with respect to it. Random Sampling allows it to generate the 200 points per cm in X direction at the fastest time base of 5 ns/cm.

Remark: 5 ns/cm is also available in other modes. In Real Time Sampling mode and 1 GSa/s on one channel each 1 ns a sample is taken, hence at 5 ns/cm there are 5 points per cm. The "missing" 195 points are generated by interpolation using sin x/x.



**Remark:**  
5 ns/cm is also available in other modes. In Real Time Sampling mode and 1 GSa/s on one channel each 1 ns a sample is taken, hence at 5 ns/cm there are 5 points per cm. The "missing" 195 points are generated by interpolation using sin x/x if "Vectors" or "Optimal" is chosen in the menu Settings Display.

**9 SAVE/RECALL (pushbutton)**

This pushbutton will open up a menu. The number of choices in this menu is dependent upon analog or digital mode being selected.

**9.1 Analog and digital mode**

Under "Save/Recall" the current instrument settings may be saved, or settings saved earlier recalled. There are 9 non volatile memories available.

**9.1.1 Saving the actual settings**

The function key "Save" opens the submenu "Front Panel Save". The function key "Page 1 2" is for page selection; the page

chosen is indicated by intensified brightness. Page 1 offers the memories 1 to 5 and page 2 the memories 6 to 9. The instrument settings (parameter) are stored in the designated memory by pressing the function key with the memory cypher.

### 9.1.2 Recall the actual settings

The function key "Recall" opens the submenu "Front Panel Recall". The function key "Page 1 2" is for page selection; the page chosen is indicated by intensified brightness. Page 1 offers the memories 1 to 5 and page 2 the memories 6 to 9. The instrument is set to the settings (parameter) recalled from the designated memory by pressing the function key with the memory cypher.

## 9.2 Digital mode



### Attention!

The following functions are not available in connection with FFT.

The menu options described in 9.1.1 and 9.1.2 are also available in digital mode. Additionally, the menu options "Reference Save" and "Reference Display" will be available. A reference is a signal which can be stored for later reference to it. 9 non volatile memory locations are provided.

### 9.2.1 Reference Save

leads to the following 3 submenus:

#### 9.2.1.1 Source (Reference)

The "Source" from which the signal - to be stored in a reference memory - originates can be selected by the INTENS knob [2].

#### 9.2.1.2 Destination RE x

There are 9 memory locations available into which reference signals from the selected source can be stored. Use the INTENS knob [2] for selection.

#### 9.2.1.3 Save

Pressing "Save" will store the signal from the source selected, into the memory selected.

### 9.2.2 Reference Display

leads to the following submenus.



### Attention!

Switching on a reference signal display, automatically switches off the display of mathematic signals and vice versa.

#### 9.2.2.1 RE x, On Off, associated settings

When in this submenu, using the INTENS knob will allow selection of 2 reference signals which can then be displayed alongside 2 input signals.

#### 9.2.2.2 RE x

After calling this function the memory location can be selected with the INTENS knob [2]. (RE 1 to 9)

#### 9.2.2.3 On Off

Control is possible with the on/off pushbutton. When the contents of the reference memory are displayed, the memory number is indicated with RE x (x = 1 to 9) at the right hand screen side. Switching to "on" will produce another menu item ("Associa. Set").



### Please note:

If both reference displays are "on" and if both memory locations are identical (e.g. RE1, RE1) the signal will be displayed twice on the same spot.

### 9.2.2.4 Associated settings

Pressing this function key causes the oscilloscope to take over the settings (parameter) stored when the signal was stored. This allows you to identify the parameters. Reference signals can also be determined if the associated settings had not been loaded.

## [10] SETTINGS (pushbutton)

Pressing this pushbutton calls the SETTINGS menu. It contains different submenus in analog and digital mode, which can be called by the associated function keys.

### 10.1 Language (Sprache)

In this submenu the language can be selected: English, German, French and Spanish are available.

### 10.2 Misc (Miscellaneous)

#### 10.2.1 Contr. Beep On Off

Switches the acoustical signal on or off, which informs about CW or CCW positions of knobs.

#### 10.2.2 Error Beep On Off

Will turn the acoustical error signal on or off.

#### 10.2.3 Quick Start On Off

In off, the HAMEG logo, the type and the version number will not be shown, the instrument will be ready immediately.

#### 10.2.4 Menu Off time

The INTENS knob [2] can be used to determine the time in which the menu is displayed before it is automatically switched off. Press the MENU OFF pushbutton [43] to switch the menu display off earlier.

If "Manual" is selected, the menus can be finished or switched over in the following way:

- Pressing the MENU OFF pushbutton [43]
- Pressing another pushbutton
- Pressing the pushbutton that called the current menu display, taking you one step back in the menu hierarchy.

### 10.3 Interface

This submenu displays the parameter of the built in, changeable interface. Parameter settings can be changed in the usual way. Further information can be found in the section "Data transfer" of this manual, if the original interface is inserted. If an optional interface is built in, the attached CD contains additional information.

### 10.4 Display

This submenu offers several modes of display:

#### 10.4.1 Dots

In this mode the samples are shown as what they are, i.e. dots (points). This representation is valuable for judging whether enough samples were gathered in order to sufficiently reconstruct a signal.

#### 10.4.2 Vectors

In this mode the sampling points are interconnected by drawing straight lines. If there are only few samples, sin x/x interpolation is used to "create" intermediate points which are then joined by straight lines.

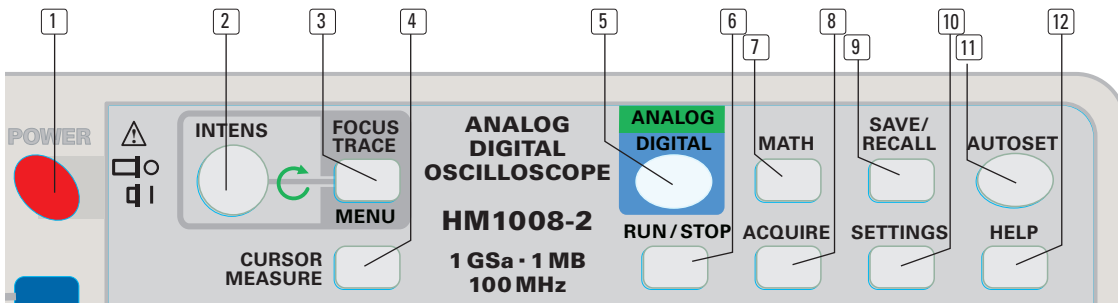

**10.4.3 Optimum display**

In this display mode, so called "Alias" signal displays can be avoided. The signals to be recorded are sampled with a higher sampling rate than that required by the time coefficient and the display resolution. This is enabled by the 1 M Byte storage capacity per signal as it enables you to store more data than actually required. As 1 M Byte data are available although only 2000 can be displayed by the crt, one sample is taken from 500 to be displayed, the sample with the highest deviation being taken. So each of the 2000 samples displayed is taken out of 500 (2000 \* 500= 1 M). This means that in comparison with 2000 k Byte memory and 2000 samples display, signal frequencies can be 500 times higher before they could cause aliasing. All samples are displayed in vector mode as described in item 10.4.2.



**Attention!**

Due to "Optimal" display more noise becomes visible as the minimum and maximum values are displayed.

**10.4.4 Status Acq. (acquisition)**

In combination of AUTO, normal and single event capture, the Pre Trigger time is displayed in % if the waiting time is higher than 1 second. After 100% has been reached, the waiting time for the trigger event is displayed. Due to the short pre trigger time in small time deflection coefficient settings, only the waiting time for the trigger event may become visible.

**10.5 Self Cal 43**

This function key leads to the submenu "Settings Self Cal". If the oscilloscope inputs are open (no inputs applied), an automatic calibration (adjustment) can be made by pressing "Start". The calibration can be aborted by pressing the MENU OFF 43 pushbutton.

The automatic calibration (adjustment) optimises the oscilloscope behaviour under the current temperature conditions, after 30 minutes warm up time.

**11 AUTOSET (pushbutton)**

Choosing AUTOSET will cause an automatic instrument setting, dependent upon the actual input signal, which selects positions, signal amplitude and time base for a reasonable display (in FFT mode optimum parameter are set). The choice of analog or digital mode will not be affected. In component test mode (available only in analog mode), XY mode, or ADD; dual channel mode will automatically be selected. If dual channel or CH1 or CH2 were previously chosen this will remain.

The digital modes Roll, Envelope or Average will be changed to refresh mode.

AUTOSET will further set the intensity to an average value if it was set too low. If a menu was opened it will be turned off by AUTOSET. During the display of HELP texts AUTOSET is not available. AUTOSET can and should be used during FFT operation to avoid misadjustment.

**12 HELP**

Pressing the HELP pushbutton will turn the signal display off and display the help text. If a menu was opened, the help text will refer to the menu, special menu or submenu option selected. If a knob is moved another help text referring to this knob will appear. Press HELP again to deactivate the text.

**13 POSITION 1 (knob)**

This knob can assume various functions which depend upon the operating mode, the functions selected with the CH1/2-CURSOR-MA/REF-ZOOM pushbutton 15 and the menu option selected.

**13.1 Y Position**

**13.1.1 Y-Position of channel 1 (analog and digital mode)**  
POSITION 1 is for Y Position CH1 control, if Yt mode (time base mode) is present and the CH1/2-CURSOR-MA/REF-ZOOM pushbutton 15 is not lit.

**13.1.1.1 Y Position of the FFT display (only in digital mode) measured with channel 1**  
Position 1 allows you to move the FFT spectrum display, the FFT reference indicator (arrow symbol at the left side of the graticule) and the FFT marker (X Symbol) in vertical direction.

**13.1.2 REF (reference) signal position ( digital mode only)**  
The POSITION 1 control functions as the position control for the signals stored in the reference memory if these conditions are fulfilled:

- 1<sup>st</sup> A reference signal must be on display (SAVE/RECALL 9)> Reference Display > (upper display area) REX (x = number of memory location, select with INTENS) > On (with or without associated settings).
- 2<sup>nd</sup> After pressing CH1/2-CURSOR-MA/REF-ZOOM pushbutton 15 > Math./Ref. was selected, the pushbutton will light up green.

The POSITION 2 knob can also serve as a Y Position control for signals stored in the reference memory, if the previously mentioned conditions are met and ON is set in the lower sector of "Reference Display".

**13.1.3 Mathematics Signal Position ( digital mode only)**  
The POSITION 1 control serves as a Y Position control for mathematics signals, if after pressing the MATH pushbutton 7 (?Mathematics > Display (upper sector)) an equation (MA1...MA5) has been chosen by the INTENS knob 2 and "?Math./Ref" has been selected (pushbutton light green) after the CH1/2-CURSOR-MA/REF-ZOOM pushbutton 15 has been activated. POSITION 2 knob can serve as a Y Position control for mathematics signals, if the previously mentioned conditions are met

and in the lower sector in the "Mathematics" menu a signal source is selected instead of "Display Off".

**13.1.4 Y position of 2nd time base B (analog mode).**

The POSITION 1 control will assume the function of Y position control of the signal displayed by time base B in alternate time base mode after the following procedure. This is convenient in order to be able to separate the displays of the (same) signal with both time bases on the screen. Press the HOR VAR (30) pushbutton > "Search". Press the CH1/2-CURSOR-MA/REF-ZOOM pushbutton (15), select the function "TB B". The pushbutton will light up green.

**13.1.5 Y position for ZOOM (digital mode.)**

This is the equivalent of the former in digital mode, where the function is called ZOOM. The POSITION 1 control will assume the function of Y position control of the zoomed signal after the following procedure. Again, the intent is to be able to separate the two displays of the (same) signal on the screen in alternate time base mode. Press the HOR VAR pushbutton (30) > "Search". Press the CH1/2-CURSOR-MA/REF-ZOOM-pushbutton (15), select "TB B". The pushbutton will light up green.

**13.2. X position in XY mode (analog and digital mode)**

POSITION 1 will function as X position control of CH1 in XY mode and provided the CH1/2-CURSOR-MA/REF-ZOOM pushbutton (15) is not lit.



**Note:**  
The HORIZONTAL control (27) will also be functional in XY mode.

**13.3. CURSOR position (analog and digital mode)**

The POSITION 1 knob (13) can be used as CURSOR Position control on condition that CURSOR display is switched on by pressing the CURSOR-MEASURE pushbutton (4) and "Cursors" or "Cur. Track" has been chosen after pressing the CH1/2-CURSOR-MA/REF-ZOOM pushbutton (15); pushbutton lit blue.



**Please note:**  
The function "Cur. Track" is only available if two cursors are indeed displayed, then both cursors can be moved simultaneously (tracking) without a change of their respective positions.

**(14) POSITION 2 (knob)**

Also this control may assume diverse functions dependent on the operating mode, the function selected via the CH1/2-CUR-

SOR-MA/REF-ZOOM-pushbutton (15) and the menu item activated.

**14.1. Y position**

**14.1.1 Y-Position of channel 2 (analog and digital mode)**  
POSITION 2 is for Y Position CH2 control, if Yt mode (time base mode) is present and the CH1/2-CURSOR-MA/REF-ZOOM-pushbutton (15) is not lit.

**14.1.1.1 Y-Position of the FFT display (only in digital mode) measured with channel 2**  
Position 2 allows you to move the FFT spectrum display, the FFT reference indicator (arrow symbol at the left side of the graticule) and the FFT marker (X Symbol) in vertical direction.

**14.1.2 Y position of reference signals (digital mode)**  
The POSITION 2 control will function as Y position control of reference signals if the following conditions are fulfilled:

1<sup>st</sup> A reference signal must be on display. [SAVE/RECALL pushbutton (9) > Reference Display > (upper display area) Rex (x = number of memory location, select with INTENS) > On (with or without associated settings).

2<sup>nd</sup> Press CH1/2-CURSOR-MA/REF-ZOOM-pushbutton (15) > Math./Ref. The pushbutton will light up green.

**14.1.3 Y position of mathematics signals (digital mode)** The POSITION 2 control functions as Y position control for mathematics signals, if the following conditions are fulfilled: Press the MATH pushbutton (7) > displays (upper display area), select an equation with the INTENS knob (2) (MA1.. MA5). Press the CH1/2-CURSOR-MA/REF-ZOOM-pushbutton (15), select Math./Ref. The pushbutton will light up green.

**14.2 Y position of CH2 in XY mode**

(Analog and digital mode.)  
POSITION 2 will function as the Y position control of CH2 in XY mode provided the CH1/2-CURSOR-MA/REF-ZOOM pushbutton (15) is not illuminated.

**14.3 CURSOR position**

(Analog and digital mode)  
The POSITION 2 knob (14) can be used as CURSOR Position control on condition that CURSOR display is switched on by pressing the CURSOR-MEASURE pushbutton (4) and "Cursors" or "Cur. Track" has been chosen after pressing the CH1/2-CURSOR-MA/REF-ZOOM pushbutton (15); pushbutton lit blue.

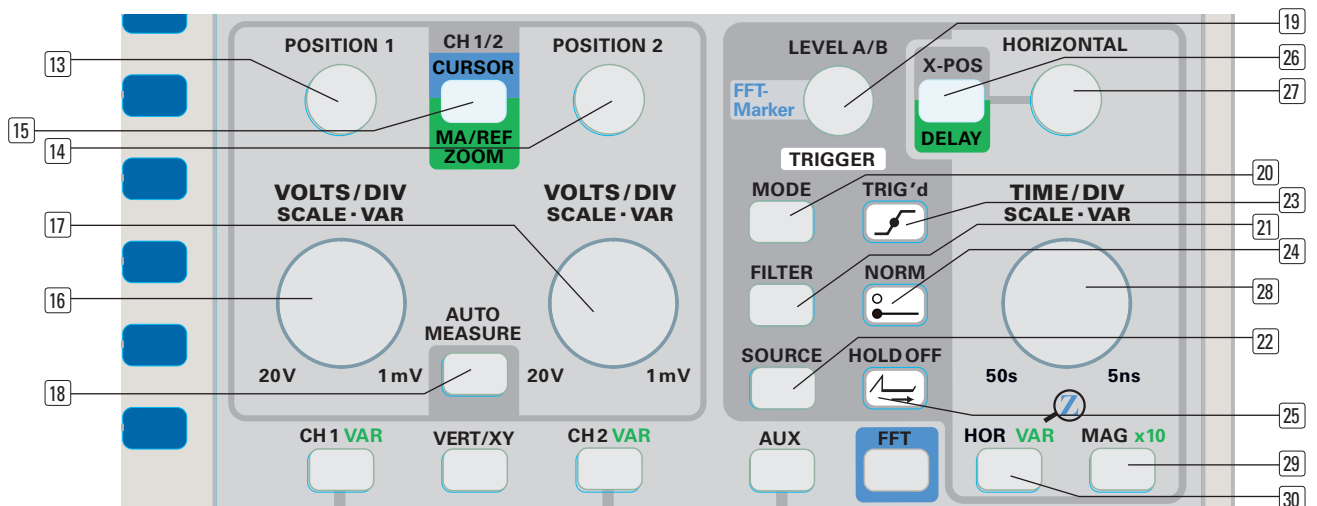



**Note:**

The function **Cur. Track (cursor tracking)** is only available if 2 cursors are on display. The cursors will then be moved simultaneously (tracking) without changing their respective positions.

**15 CH1/2-CURSOR-MA/REF-ZOOM** (pushbutton)

The function of the POSITION 1, POSITION 2 and VOLTS/DIV knobs can be selected if suitable operating conditions are present (cursor measurement, mathematic signal- and reference signal display, ZOOM- and time base Search function). Then a menu will be called by pressing this pushbutton and it will light.

The pushbutton will signal the function activated corresponding to the front panel labelling:

- dark: Y position and vertical sensitivity CH1 and CH2.
- blue: Y position of cursors.
- green: Y position and display height of:
  - Mathematics signal(s)
  - Reference signal(s)
  - ZOOM or time base B display of signal(s)

**16 VOLTS/DIV-SCALE-VAR** (knob)

This knob is a multi function CH1 control.

**16.1 Selection of vertical sensitivity (1-2-5 sequence)**

This function is present if the CH1 VAR button **31** is not lit. Provided VAR on pushbutton CH1 is not illuminated the sensitivity will be calibrated. Turning the control CCW will decrease and turning it CW will increase the sensitivity. 1 mV/cm to 20 V/cm can be selected in a 1-2-5 sequence. The readout will display the calibrated sensitivity (e.g. "CH1: 5mV.."). Depending on the sensitivity selection, the signal will be shown with smaller or greater amplitude.



**Please note:**

This sensitivity selection is always active, e.g. also, if CH2 only was chosen. In that case CH1 may be used as trigger source.

**16.2 Variable control**

This function can be activated by pressing the CH1 VAR pushbutton **31** and selecting On by the "Variable" function key. The CH1 VAR pushbutton **31** lights and indicates that the VOLTS/DIV-SCALE-VAR knob **16** now serves as Variable control. Thereafter the deflection coefficient can be changed continuously between 1 mV/cm and >20 V/cm and thus the signal display height. If uncalibrated, the deflection coefficient will be displayed as e.g. "...>5mV..." and correspondingly the results of cursor voltage measurement. In calibrated condition e.g. "...:5mV..." will be displayed.

If variable "off" is activated in the CH1 menu, the deflection coefficient becomes calibrated, the CH1 VAR pushbutton **31** does not light any longer and the VOLTS/DIV-SCALE-VAR knob **16** returns to 1-2-5 sequence.

**16.3 Scaling the FFT display** (digital mode only)

**16.3.1 Preliminary note:**

To avoid erroneous spectrum displays, it must be checked before switching over to FFT, that the Yt (time base) signal display is suitable for calculation in FFT. This means that the time base setting (sampling rate) must enable the display of minimum one signal period; in the case of complex signals this is regarding the signal with the lowest frequency. On the other hand the sampling rate must not be too low (too many signal periods) to avoid so called aliasing. The signal display height should be

between 5 mm (0.5 div.) and 8 cm (8 div.). Signal display heights > 8 cm, cause the danger that the dynamic range is exceeded, so that signals deformed by limiting effects to square wave form, become digitised and at least show spectrum displays spectra that do not exist in reality. If the sampling rate is too low the readout displays "ALS"; if the signal is too high "overrange ±" will be displayed.

Such problems can be avoided, by pressing the AUTOSET pushbutton **11** before switching over to FFT or during FFT mode.

**16.4.2 Scaling**

In FFT mode the VOLTS/DIV-SCALE-VAR knob **16** only changes the scaling of the spectrum display; this means that the spectrum (including noise) is displayed in double height after switching over from 20dB/cm to 10dB/cm. The Y deflection coefficient previously selected in Yt mode is thereby not affected.

If dBV is set in the FFT menu, the scaling is switched over from 5dB/cm to 500 dB/cm in 1-2-5 sequence by the VOLTS/DIV-SCALE-VAR knob **16**; at  $V_{(rms)}$  the range is from 10  $\mu$ V/cm to 20V/cm also switched in 1-2-5 sequence. Please note that in contrast to Yt and XY signal display modes, rms values are displayed, not peak to peak values.

**17 VOLTS/DIV-SCALE-VAR** (knob)

This multi function control belongs to CH2.

**17.1 Selection of vertical sensitivity (1-2-5 sequence)**

This function is present if the CH2 VAR-pushbutton **33** is not lit.

The sensitivity will be calibrated provided VAR on the CH2 pushbutton is not illuminated. Turning the control CCW will decrease, turning it CW will increase the sensitivity. The sensitivities can be selected from 1 mV/cm to 20 V/cm in a 1-2-5 sequence. The readout will show the sensitivity (e.g. "CH2:5mV.."). Depending on the sensitivity the signal will be displayed with smaller or greater amplitude.



**Please note: The sensitivity control is always active, i.e. also if CH2 is not selected. CH2 may then still be used e.g. as a trigger source.**

**17.2 Variable control**

This function can be activated by pressing the CH2 VAR pushbutton **33** and selecting On by the "Variable" function key. The CH2 VAR pushbutton **33** lights and indicates that the VOLTS/DIV-SCALE-VAR knob **17** now serves as Variable control. Thereafter the deflection coefficient can be changed continuously between 1 mV/cm and >20 V/cm and thus the signal display height.

If uncalibrated, the deflection coefficient will be displayed as e.g. "...>5mV..." and correspondingly the results of cursor voltage measurement. In calibrated condition e.g. "...:5mV..." will be displayed.

If variable "off" is activated in the CH2 menu, the deflection coefficient becomes calibrated, the CH2 VAR pushbutton **33** does not light any longer and the VOLTS/DIV-SCALE-VAR knob **17** returns to 1-2-5 sequence.

**17.3 Scaling the FFT display** (digital mode only)

**17.3.1 Preliminary note:**

To avoid erroneous spectrum displays, it must be checked before switching over to FFT, that the Yt (time base) signal display is suitable for calculation in FFT. This means that the time base

setting (sampling rate) must enable the display of minimum one signal period; in case of complex signals this is regarding the signal with the lowest frequency. On the other hand the sampling rate must not be too low (too many signal periods) to avoid so called aliasing. The signal display height should be between 5 mm (0.5 div.) and 8 cm (8 div.). Signal display heights > 8 cm, cause the danger that the dynamic range is exceeded, so that signals deformed by limiting effects to square wave form, become digitised and at least show spectrum displays spectra that do not exist in reality. If the sampling rate is too low the readout displays "ALS"; if the signal is too high "overrange ±" will be displayed.

Such problems can be avoided, by pressing the AUTOSET pushbutton [11] before switching over to FFT or during FFT mode.

**17.3.2 Scaling:**

In FFT mode the VOLTS/DIV-SCALE-VAR knob [17] only changes the scaling of the spectrum display; this means that the spectrum (including noise) is displayed in double height after switching over from 20 dB/cm to 10 dB/cm. The previously in Yt mode selected Y deflection coefficient is thereby not affected.

If dBV is set in the FFT menu, the scaling is switched over from 5dB/cm to 500dB/cm in 1-2-5 sequence by the VOLTS/DIV-SCALE-VAR knob [16]; at  $V_{(rms)}$  the range is from 5mV/cm to 20V/cm also switched in 1-2-5 sequence. Please note that in contrast to Yt- and XY mode signal display, no peak to peak values but rms values are displayed.

**[18] AUTO MEASURE (pushbutton)**

AUTO MEASURE can not be called if XY or FFT mode is present.

On condition that the AUTO MEASURE function was switched off, it will be switched on by pressing the AUTO MEASURE pushbutton and simultaneously the AUTO MEASURE measuring results are displayed in the top right position of the readout below trigger information.

Pressing the AUTO MEASURE pushbutton for the second time, opens the menu "Measure" and a selection box. Additionally the FOCUS TRACE MENU pushbutton [3] lights, indicating that the INTENS knob [2] now has a function related to the menu item selected in the "Measure" menu.

The measuring result is displayed by the readout in top right position, one line below trigger source, slope and coupling.

Dependent on the mode, different measurements are offered in this menu, all relating to the trigger signal.

**In principle the following conditions must be met:**

- a) Trigger conditions must be present if frequency or period time measurement is performed. For signals under 20 Hz normal triggering is required. Please note that very low frequency signals require several seconds measuring time.
- b) DC input and dc trigger coupling must be present if dc voltages or the dc content of signals which contain DC and AC the DC content are to be measured.

**Please note:**

- Due to the frequency response of the trigger amplifier the measuring accuracy decreases at higher frequencies.
- Related to the signal display there are deviations originating from the different frequency response of the Y measuring amplifier and the trigger amplifier.
- The measuring result follows the signal form when low frequency (<20 Hz) voltages are measured.
- Measuring pulse shaped voltages cause deviations between the real and the displayed values. The deviation height depends on the pulse ratio and the selected trigger slope.
- The signal to be measured must be displayed within the graticule limits to avoid measuring errors.
- On condition the variable function is switched on the ... VAR pushbutton is lit, the deflection coefficient and/or the time base are/is uncalibrated and a ">" sign is displayed by the readout in front of the deflection coefficient. The results of voltage and/or time/frequency measurement are labelled in the same way.



**Attention!**

**Due to the danger of mismeasurement, complex signals should be measured by aid of the cursors.**

**18.1 Measuring mode**

If this function is chosen, one of the measuring modes shown in the selection box list can be selected with the INTENS knob [2] options. In most cases the unit related to the measuring mode will be displayed automatically. The measuring function is self explanatory.

When "Signal Freq." (signal frequency) and "Signal Period" are measured in digital mode, the measuring result originates from the signal data and not from the trigger signal. Thus the time coefficient must be set such that a minimum of one signal period is displayed.

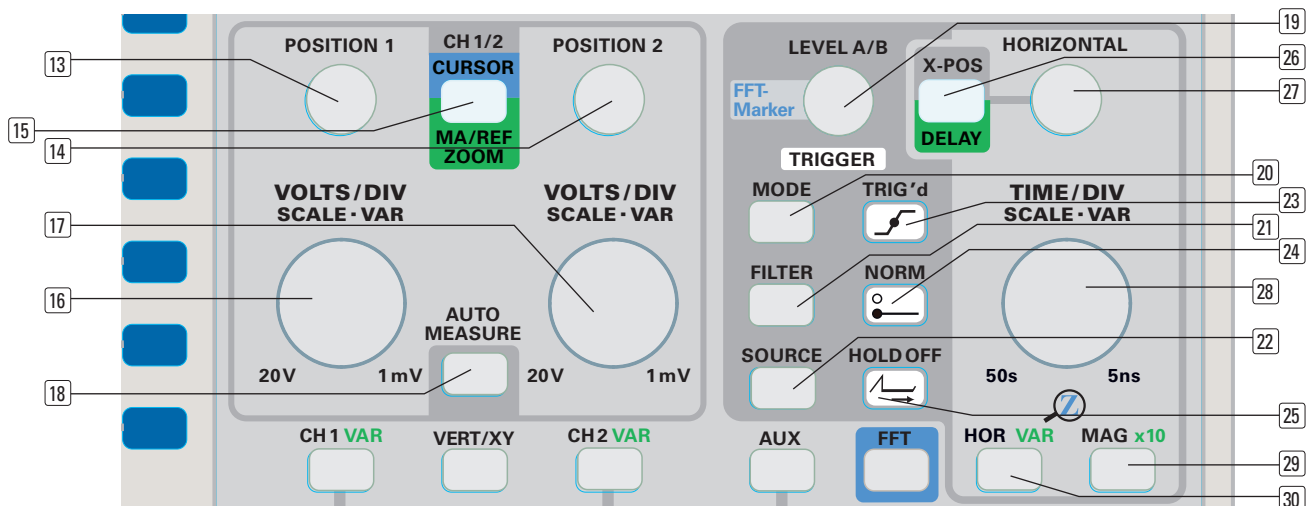

## 18.2 Respect

**18.2.1** "Respect Tr" indicates that the trigger signal is used for measurement. If e.g. the signal applied at channel 1 serves as trigger signal (internal triggering) the displayed measuring value is related to this signal.

**18.2.2** CH1 or CH2 indicate the trigger signal source. If the INTENS knob [2] symbol is displayed, the source can be chosen with the INTENS knob [2].

## 18.3 Off

Pressing the function key "Off" switches AUTO MEASURE and the menu display off.

The menu can be left without switching AUTO MEASURE off by pressing the MENU OFF pushbutton [43].

## [19] LEVEL A/B – FFT Marker (knob)

The knob function depends on Yt or FFT mode.

### 19.1 Yt mode

The LEVEL control allows you to set the trigger level, i.e. the voltage or signal level, which will generate a trigger to start the time base whenever the signal passes that level. In most Yt modes the readout will show a symbol the vertical position of which indicates the signal point which will trigger. The trigger symbol will be "parked" on the second graticule line from the bottom in those modes where there is no direct relationship between trigger signal and trigger point.

In normal trigger mode the LEVEL control will move the trigger symbol anywhere. In automatic peak triggering mode (automatic trigger (AUTO) in combination with AC trigger coupling), the level can only be selected between the signal's peak values; without signal the trigger symbol can not be moved. The movement of the trigger symbol is vertical only. The range of this symbol is limited so that it will not overwrite other readout information. As soon as the trigger symbol leaves the graticule its form will change, this change indicates in which direction the trigger symbol left the graticule.

Analog mode only: Depending on the time base mode the LEVEL control will affect the time base A or B triggering. Press the HOR VAR pushbutton [30] in order to select the time base mode in the "Time base" menu. In "Search" mode (alternate time base mode) the last trigger level setting for time base A will remain valid (graticule left) if time base B is switched to triggered mode. (Menu "Time base": set B trigger to positive or negative slope). Thereafter the LEVEL A/B control will control the time base B trigger, a second trigger point symbol will be shown and marked with "B".

### 19.2 FFT mode

The FFT control will move the marker („X" Symbol) over the frequency range. The marker follows the displayed spectra. The readout additionally displays the frequency on which the marker is set ("MX:xxxMHz") and the level („MY:xxdB" respectively "MY:xxV").

## [20] MODE (pushbutton)

### Preliminary note!

The pushbuttons MODE [20], FILTER [21] and SOURCE [22] refer to the trigger unit. In XY mode these pushbuttons are without effect as XY displays are untriggered.

Pressing this pushbutton will open the "Trigger" menu, where Auto, Normal, Single (sweep triggering) can be selected. Choos-

ing "Slope" will allow trigger on any signal shape. For video signals select "Video" and press the FILTER pushbutton [21] in order to find a choice of special trigger modes for composite video signals.

In digital mode also "Logic" will be offered, allowing trigger on logic signals. The explanations can be found in: FILTER [21] and SOURCE [22].

In XY mode the pushbuttons MODE [20], FILTER [21] and SOURCE [22] are disabled as there is no triggering in XY mode.

## 20.1 Auto (trigger)

Automatic triggering (Auto) is active if the NORM display [24] is not illuminated. In "Auto" the analog time base or signal capture (digital mode) will be periodically started even if there is no signal or when no triggers are generated because the settings are incorrect. Signals of <20 Hz can not be triggered as the automatic start will have occurred before the signal arrived. Automatic triggering is possible with or without peak detection. The LEVEL A/B [19] control will be active in both modes.

In peak detection mode the range of the level control is limited to the peak to peak voltage of the signal. Without peak detection any level can be set. If the trigger level is set such that no triggers are generated the automatic triggering will nevertheless start the time base. The signal will thus remain visible but will be untriggered.

Automatic peak triggering is active if automatic triggering (MODE: AUTO) is chosen in combination with the trigger FILTER setting AC (trigger coupling). The active mode will be shown by the behaviour of the trigger point symbol when turning the LEVEL knob.

## 20.2. Normal (trigger)

If the NORM LED [24] lights up, normal triggering was selected. In normal trigger mode both the peak detection and the automatic time base start will be disabled. Hence if there is not sufficient trigger signal, the screen will remain dark in analog mode. In digital mode signal capturing will also stop unless the roll mode was selected.

In normal trigger mode there is no lower frequency limit for signals. Without trigger, the last signal capture will be displayed as long as the oscilloscope settings are not changed.

## 20.3 Single (sweep/capture)

In single sweep/capture mode the time base selected will accept only one trigger for one sweep/capture after it was armed. The NORM LED will light up, Auto triggering is disabled and the RUN/STOP lit periodically.

For further information about the precise operation see RUN/STOP pushbutton [6] description.

## [21] FILTER (pushbutton)

Preliminary note!

The pushbuttons MODE [20], FILTER [21] and SOURCE [22] refer to the trigger unit. In XY mode these pushbuttons are without effect as XY displays are untriggered.

After this pushbutton is depressed it will depend on the settings chosen in MODE [20] (Edge, Video, Logic) which menu will be offered. In XY mode the pushbuttons: MODE [20], FILTER [21] and SOURCE [22] are disabled as XY displays can not be triggered.

## 21.1 Menu: Slope

The menu "Edge" will appear if "Edge" was selected in the "Trigger" menu to be called with MODE [20] pushbutton and after the

FILTER **21** pushbutton was depressed. For further information see "Trigger coupling" (Menu "FILTER") under the heading "Triggering and time bases" and the instrument specifications. The following settings are available:

**21.1.1 Trig. Filter**

- **AC:** The trigger signal is AC coupled via a large capacitor in order to reach a low cut off frequency. If on condition AC coupling automatic triggering (MODE: AUTO) is selected, automatic peak triggering is active.  
Readout: "Tr:Source, Slope, AC"
- **DC:** The trigger signal is DC coupled. No peak triggering is possible.  
Readout: "Tr: Source, Slope, DC"
- **HF:** AC coupling with a small capacitor suppressing low frequency signals. Hence the signal display and the trigger signal derived are no longer identical, the trigger point symbol will be "parked" in digital mode and will not react to the LEVEL A/B **19** control. In analog mode the trigger point symbol is switched off. As a combination of HF coupling and LF or Noise Reject is not meaningful, both menu options will not be shown. No peak triggering is possible.  
Readout: "Tr:Source, Slope, HF".
- **LF:** The trigger signal is sent through a low pass filter to suppress high frequency components. As this will suppress hf, the noise rejection mode will be set to OFF automatically. No peak triggering is possible.  
Readout: "Tr:Source, Slope, AC or DC, LF".
- **Noise Reject:** Noise rejection (reduction) means a reduced trigger amplifier bandwidth and consequently less trigger signal noise.  
Readout: "Tr:Source, Slope, AC or DC, NR".

**21.1.2 Slope**

"SLOPE" determines whether the rising or falling portion of a signal shall trigger, the level is set with the LEVEL A/B control **19**. In "Both mode" both slopes will trigger, this is also true in single sweep mode. This allows e.g. the display of eye patterns.

**21.2 Menu: Video**

In order to reach the menu "Video" proceed as follows: Press MODE **20** to open the "Trigger" menu, select "Video", then press the FILTER **21** pushbutton. Further information can be found under "Video" (tv signal triggering) in the chapter "Triggering and time bases" and in the instrument specifications. The following settings are available:

**21.2.1 Frame, Line.**

Depending on the setting chosen, triggering will be on frame or line sync pulses. The selection will also affect other menu items.  
Readout: "Tr:Source, TV".

**21.2.1.1 Frame**

- **ALL:** In this mode the sync pulses of each half frame can trigger.
- **Even:** In this mode only the sync pulses of even half frames can trigger.
- **Odd:** In this mode only the sync pulses of odd half frames can trigger.

**21.2.1.2 Line.**

- **All:** In this mode all line sync pulses can trigger.
- **Line No:** The line number with its line pulse that is used for triggering can be selected with the INTENS knob **2**.
- **Line min:** One pushbutton operation will be sufficient to switch back to the lowest possible line number.

**21.2.2 Norm**

The pushbutton allows the selection of the US standard of 525 lines and 60 Hz or the European standard with 625 lines and 50 Hz. With change of standard, the line number will be automatically changed, too.

**21.2.3 Polarity**

Composite video signals may have both polarities. Selection of the correct polarity is vital, as the scope should be triggered by the sync pulses and not the video content. Positive polarity is defined by the video content being more positive than the sync signals and vice versa. If the polarity was wrongly selected there will be no triggering at all, an untriggered display or no signal capture.

**22 SOURCE (pushbutton)**

Preliminary note!

The pushbuttons MODE **20**, FILTER **21** and SOURCE **22** refer to the trigger unit. In XY mode these pushbuttons are without effect as XY displays are untriggered.

Depressing this pushbutton will call various menus depending on the previously selected mode (MODE **20** pushbutton): Edge, Video, Logic. In XY mode the pushbuttons: MODE **20**, FILTER **21**, SOURCE **22** are disabled as XY displays can not be triggered. In the "Trigger SOURCE" menu the source is selected from which the trigger signal is to be taken. The options depend on the actual mode of the scope.

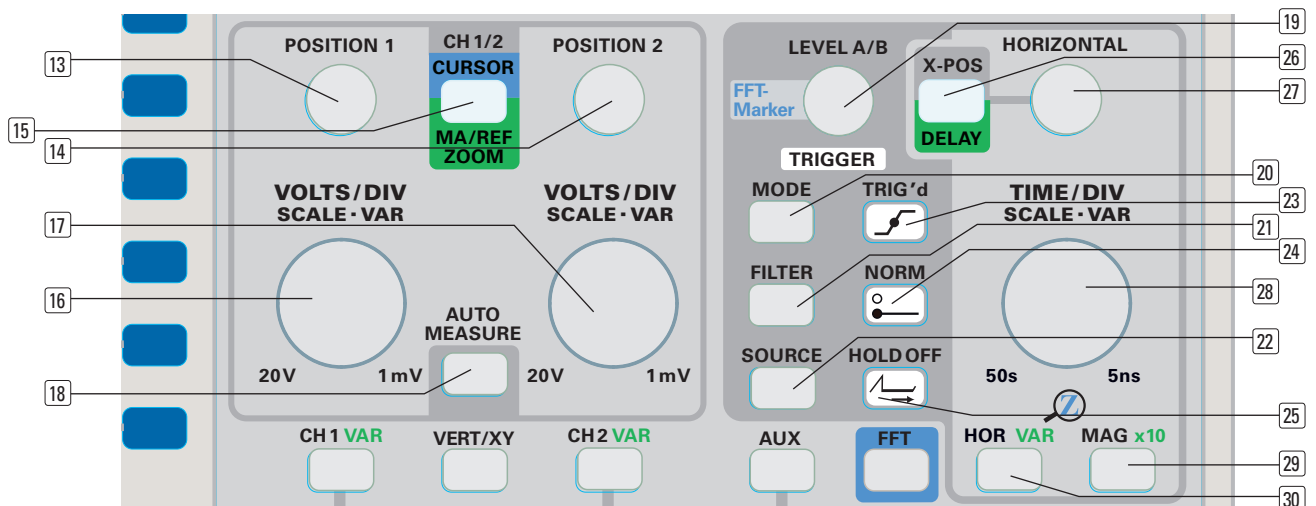

## 22.1 Edge/VideoTrigger

### 22.1.1 CH1

Conditions: Analog or digital mode, "Edge" or "Video" selected. CH1 will then be the trigger source, no matter whether it is displayed or not. Readout: "Tr:CH1, (Slope), Filter (TV)".

### 22.1.2 CH2

Conditions: Analog or digital mode, "Edge" or "Video" selected. CH2 will then be the trigger source, no matter whether it is displayed or not. Readout: "Tr:CH2, (Slope), Filter (TV)".

### 22.1.3 Alt. 1/2

Conditions: Analog mode, "Edge" Triggering". Alternate triggering with the signals from channels 1 and 2 as described in the section "Alternate Trigger" of chapter "Triggering and time bases". Please note that in this trigger mode the apparent time relationships between the two signals on the screen are meaningless and misleading, the relative position of the two signals depends only on their shape and the trigger level selected.

In dual channel mode (DUAL) alternate triggering is only possible in conjunction with alternate dual channel operation. If previously dual trace chopped mode was selected (VERT/XY pushbutton (32) > DUAL chop) it will be automatically changed to alternate mode when alternate triggering is selected. After "Alt. 1/2" is turned off dual trace chopped mode may be selected again. Readout: "Tr:alt, Slope, Filter".

### 22.1.4 External

In this mode the trigger signal comes from the external trigger input (AUXILIARY INPUT). Readout: "Tr:ext, Slope, Filter".

### 22.1.5 AC Line

The trigger signal is taken from the line (mains supply) which feeds the scope. See also the section "Line triggering" in the chapter "Triggering and time bases". Readout: "Tr:alt, Line, Slope".

## 23 TRIG'd display (not in XY mode)

This LED will light up if the time base receives a signal suited for triggering at the instruments present trigger settings. It depends upon the trigger signal whether the LED will just blink or remain illuminated.

## 24 NORM display

This display will light up provided "Auto" triggering was not selected. The mode can be selected in the "Trigger" menu called by pressing (MODE (20)). The light indicates that the screen will remain dark as long as there is not sufficient trigger signal.

## 25 HOLD OFF display (Analog mode only)

This display will light up if the hold off time was set to > 0% in order to indicate that the longer than minimum hold off time may cause a lower rep rate of the time base and thus a darker display. Setting the hold off time requires pressing the HOR VAR pushbutton (30) which calls the menu "Time base". Only the time base A hold off time may be changed. See the section "Hold off time setting" in the chapter "Triggering and time bases".

## 26 X-POS DELAY (pushbutton)

no function in FFT mode

This pushbutton allows you to change the function of the HORIZONTAL knob (27).

### 26.1 Analog mode

The pushbutton signals the actually selected function in accordance with the front panel lettering:

dark: X position control  
green: Delay time control

#### 26.1.1 X POS

If the pushbutton is dark the HORIZONTAL knob (27) functions as X position control, i.e. it moves the signal display horizontally. The position control is especially useful when the magnifier (MAG. x 10 (29)) is switched on. The magnifier will magnify the display 10 times around the screen centre. Using the POS control, the portion of the signal to be studied can be shifted on the screen.

#### 26.1.2 DELAY

In order to change the function of the HORIZONTAL knob (27) to "Delay" proceed as follows:

Press the HOR VAR pushbutton (30) which will present the "Time base" menu, select "Search" or "B only", then the function of the knob will be changed if the pushbutton is depressed. It will light up to show that the knob is now the delay time control.

In "Search" mode both traces (time base A and B) alternate. Unlike the former time base "A only" mode, a sector with higher intensity is visible on the A trace. This sector can be moved continuously by the delay time control. The time between the A trace start and the beginning of the intensified sector is the delay time. This information is also displayed in the readout ("Dt: ...") and is an aid to find the position of the intensified sector which may be very small. If time base "B only" is chosen the intensified sector is no longer visible, but the DELAY function still can be used.

Without activated "B Trigger" function, the B time base will be started after the A time base delay time "elapsed".

### 26.2 Digital mode

The pushbutton will indicate the actual function in accordance with the front panel lettering:

dark = Post- and Pre Trigger control (moves the trigger point in horizontal direction).  
green = Delay time control for horizontal Zoom position=shift.

#### 26.2.1 X-POS delay

If the pushbutton is dark the HORIZONTAL (27) knob functions as X position control of the trigger time, i.e. it moves the trigger point symbol horizontally. This allows display of signal portions before and after the trigger, called Pre Trigger and Post Trigger. If the trigger point symbol is located on the screen centre the readout will show "Tt:0s", hence the trigger time indication is always referred to the screen centre. Values with a positive sign are Post Trigger times, those with a negative sign Pre Trigger times. If the X POS DELAY pushbutton is depressed the "Hor.Knob" menu will be called, it contains the following options:

1<sup>st</sup> Centre: Pressing the function pushbutton "Center" will set the trigger time to the screen centre "Tt:0s" which is the standard setting.

2<sup>nd</sup> Coarse On Off: changes the speed of the HORIZONTAL knob (27).

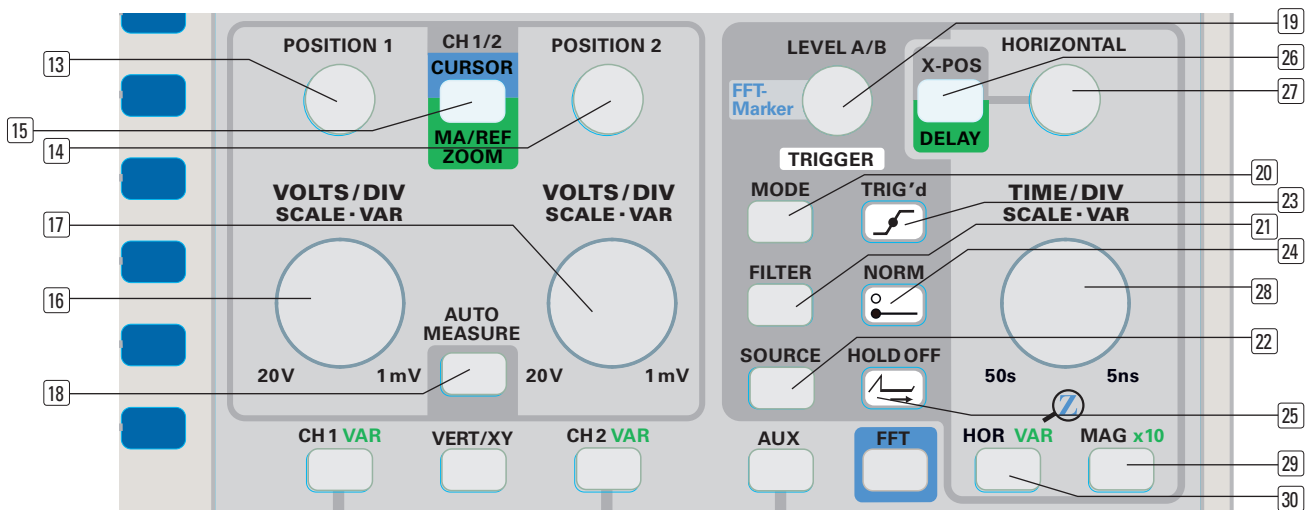

**26.2.2 DELAY Zoom Pos**

This pushbutton will be illuminated if the "Time base" menu was called with the HOR VAR pushbutton (30) and "Search" selected. The HORIZONTAL (27) knob can then be used to select a portion of the time base display which is to be displayed expanded in time.

In "Search" mode the normal and the expanded displays are displayed simultaneously, if neither reference nor mathematic signals are displayed. The expanded portion of the signal will be shown on the normal display as an intensified sector. The length of this sector is dependent upon the setting of the 2nd "Z", time base which is shown in the readout as "Z..." and is equal to the run time of the Z time base.

**27 HORIZONTAL (knob)**

The various functions of this knob depend on the operating mode and are described under X POS DELAY pushbutton (26).

**FFT (digital mode only)**

As in Yt mode this knob moves the display in X direction. This changes the frequency range and consequently the center frequency setting displayed in the readout.

**28 TIME/DIV.-SCALE-VAR (knob)**

This knob is normally used as the time base speed selector, but has also other functions depending on the operating mode. In XY mode this control is disabled.

**28.1 Analog mode**

**28.1.1 Time base A time/cm selection**

This function is active if in the "Time base" menu HOR VAR pushbutton (30) "A only" is selected and the option "A variable On Off" is set to Off.

Turning the knob CCW will decrease, turning it CW will increase the time base speed. The time base speed may be chosen between 500 ms/cm... 50 ns/cm in a 1-2-5 sequence and will be calibrated. The readout will show the setting (e.g. "A:50ns").

**28.1.2 Time base B time/cm selection**

This function is active if in the "Time base" menu HOR VAR pushbutton (30) "Search" or "B only" was selected and the option "B variable On Off" was set to Off. Turning the control CCW will decrease, turning it CW will increase the time base speed. The speed can be selected between 20 ms/cm.. 50 ns/cm in a 1-2-5

sequence and will be calibrated. The readout will show the speed (e.g. "B:50ns"). The time base B allows display of portions of the time base A display on an expanded time base scale. This implies that the speed of TB B must always be greater than that of TB A. Therefore with the exception of 50 ns/cm, TB B can not be set to the same speed as TB A or slower.

Further information is available in the section "Time base B (2nd time base) / Delay / Triggering" (Analog mode) in the chapter "Triggering and time bases".

**28.1.3 Variable**

The TIME/DIV-SCALE-VAR control may also be used to change the time base speed continuously but uncalibrated. VAR will light up on top of the HOR VAR pushbutton (30) in order to warn that the time base is uncalibrated and the knob has now that function.

In order to arrive at that function press HOR VAR pushbutton (30) which calls the "Time base" menu. Depending whether time base A or B is selected either "A variable On Off" or "B variable On Off" will be shown. The function pushbutton can then be used to select On/Off.

In order to point out that the time base is now uncalibrated the readout will replace ":" by ">" preceding the time/cm. (e.g. "A>500ns" and "B>200ns"). Also the results of cursor time/period measurements will be marked that way.

**28.2 Yt digital mode**

**28.2.1 ZOOM OFF (A time base time/cm selection)**

Select the menu "Zoom" by pressing HOR VAR pushbutton (30) and then "Off" in order to set the function of the knob TIME/DIV-SCALE-VAR to time base A speed as in analog mode. If "Zoom Off" is active, the whole memory will always be displayed. Turning the control CCW will decrease and turning it CW will increase the time base speed. Depending on the signal capture/display the time base can be set from 50 s/cm to 5 ns/cm in a 1-2-5 sequence (e.g. "A:50ns") and will be calibrated. There is no variable function as in analog mode.

**28.2.2 Search Zoom only (Zoom time base speed selection)**

One of the functions "Search" or "Zoom only" may be selected in the "Zoom" menu after pressing HOR VAR pushbutton (30). "Zoom Off" is equivalent to time base A in analog mode. With "Zoom only" a portion of the display in Zoom "Off" can be expanded over the whole screen. This is possible because there is a very large memory for signal capture/display. The "Zoom Off" display will present the whole memory contents. With "Search" both the "Zoom Off" and the expanded "Zoom only"

displays will be visible. With "Zoom only" only the expanded display will show up.

The Zoom time base speed will be indicated in the readout "Z:..." and is calibrated. Turning the knob CCW will decrease and turning it CW will increase the time base speed. This can be selected from 20 ms/cm to 5 ns/cm in a 1-2-5 sequence. The maximum expansion is 50,000 times ("A:10ms" and "Z:200ns".)

**28.3 XY digital mode**

As XY mode is untriggered, all trigger related controls (LEVEL A/B (19), MODE (20), FILTER (21) and SOURCE (22) are deactivated. The same applies regarding the ZOOM function (HOR VAR (30) and X POS DELAY (26)), the X magnifier (MAG x10) and all functions not meaningful in XY mode.



**Attention!**

The TIME/DIV-SCALE-VAR knob (28) is active, because sampling is required in digital XY mode and consequently the sampling rate must be set. Thus the readout displays the sampling rate but no time deflection coefficient.

It is recommended to choose a suitable sampling rate in Yt mode and then switch over to XY mode. A suitable sampling rate is when both signals are displayed with one complete signal period. With increasing number of displayed signal periods a degradation of the XY signal display takes place.

**28.4 FFT (digital mode)**

**28.4.1 Preliminary note:**

To avoid erroneous spectrum displays, it must be checked before selecting FFT, that the Yt (time base) signal display is suitable for calculation in FFT. This means that the time base setting (sampling rate) must enable the display of minimum one signal period; with complex signals this is regarding the signal with the lowest frequency. On the other hand the sampling rate must not be too low (to many signal periods) to avoid so called aliasing. The signal display height should be between 5 mm (0.5 div.) and 8 cm (8 div.). Signal display heights >8 cm, cause the danger that the dynamic range is exceeded, so that signals deformed by limiting effects to square wave form, become digitised and at least show spectrum displays spectra that do not exist in reality. If the sampling rate is too low the readout displays "ALS"; if the signal is too high "overrange ±" will be displayed.

Such problems can be avoided, by pressing the AUTOSET pushbutton (11) before switching over to FFT or during FFT mode.

**28.4.2 Scaling:**

For better understanding in some cases the term sampling frequency is used instead of sampling rate although the readout displays the sampling rate. A sampling rate display of 40 MSa (40 Megasamples per second) is the equivalent of a sampling frequency of 40 MHz.

The current sampling rate setting in Yt (time base) mode automatically sets the center frequency and span in Yf (FFT) mode after switchover from Yt (time base) to Yf (FFT) mode. In FFT mode the TIME/DIV.-SCALE-VAR can be used for changing the span (SCALE function, expanding the frequency axis) and not the sampling frequency setting.

The readout displays the sampling rate, center frequency and span setting together with other parameters in FFT mode. From the sampling frequency (rate) setting the theoretically highest

displayable frequency ( $f_{max}$ ) results. In accordance with the Nyquist-Shannon sampling theorem, the highest frequency to displayed must be  $2 * f_{max}$ . At a sampling rate of 1 GSa/s – corresponding to a sampling frequency of 1 GHz – the maximum displayable frequency is below 500 MHz (1 GHz / 2). In practice the frequency response of the oscilloscope must be taken into account (e.g. 100 MHz -3dB); this means that the voltage height of a 100 MHz is displayed with 0.707 V although the real value is 1 V. This error becomes larger with even higher frequencies.

The center frequency corresponds with the vertical graticule line in the screen center with direct relation to the frequency span that displays the frequency range from the left to right graticule border lines. The display "Center:10.00MHz" and "Span:20.0MHz" indicates that the left graticule border line coincides with 0 Hz, the vertical center line with 10 MHz and nearly 20 MHz are displayed at the right border line. Under these conditions the sampling frequency is 40 MHz (Readout: 40 MSa).

**(29) MAGx10 (pushbutton)**

In analog mode only: pressing this pushbutton will turn on the x 10 magnifier. No menu will be shown. If "x10" is illuminated on the MAG pushbutton the magnifier is activated. The adjusted time/cm will be shown in the top left readout. Depending on the time base mode turning on the magnifier will have these effects:

**29.1 "Time base A only"**

The display will be expanded around the screen centre by a factor of 10, the time/cm indication adjusted accordingly.

**29.2 "Search" (A and B times bases alternated)**

The time base A speed will not be affected. The time base B speed will be increased by a factor of 10, hence the time base B display will be expanded 10 fold in X direction.

**29.3 "B only"**

The time deflection coefficient reduces by factor 10 causing a tenfold X magnification (signal expansion).

**(30) HOR VAR (pushbutton)**

This pushbutton will open the "Time base" menu, the contents of which depend on the operating mode selected.

**30.1 Analog mode**

The following modes are available:

**30.1.1 A only**

In this setting only time base A is active and thus in the top left position the readout displays only "A...". The TIME/DIV-SCALE-VAR knob (28) only effects time base A. By aid of the MAG x10 pushbutton (29) the signal display can be expanded 10 fold; reducing the time deflection coefficient by factor 10.

If the mode is changed from time base A to "Search" or "B only" all settings of time base A remain intact including triggering.

**30.1.2 Search**

This mode implies alternate time base operation. The readout will show the speeds of both time bases ("A..." and "B..."). The TIME/DIV-SCALE-VAR knob will set the time base B speed. In alternate time base mode part of the time base A display will be intensified. The horizontal position of the intensified portion may be shifted using the HORIZONTAL knob (27), provided its function was set to "Delay", this is the case if the X-POS DELAY

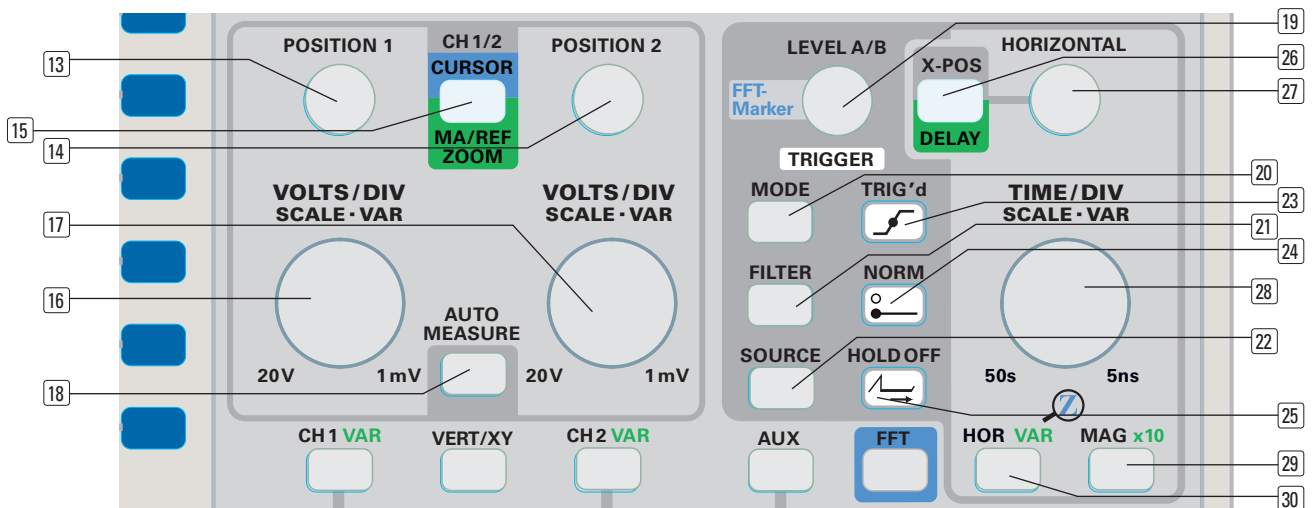

[26] pushbutton is illuminated. The length of the intensified sector is determined by the speed of time base B and is equal to the run time of B. Hence this intensified portion of A will be spread over the full screen as displayed by B and thus expanded. The Y position of the signal is the same when displayed with either A or B. This means, however, that both displays will be written over each other.

This can be avoided by changing the time base B trace position in the following way: Press the CH1/2-CURSOR-MA/REF-ZOOM-pushbutton [15] to call the "Pos./Scale" menu. Then press the function key "TB B" so that the POSITION 1 knob [13] becomes the trace separation control [see 13.1.5 Y Position - 2nd time base]. As there is only a demand for trace separation in "Search mode" this function is only offered in this time base mode.

Also in "Search" the 10 x magnifier is available by pressing the pushbutton MAG x10 [29]. The magnifier will affect solely time base B.

### 30.1.3 "B only"

In this mode only time base B will be displayed. Thus the readout only displays in the top left position only "B". The TIME/DIV-SCALE-VAR knob then only affects time base B. By aid of the MAG x10 pushbutton [29] the signal display can be expanded 10 fold; reducing the time deflection coefficient by factor 10.

### 30.1.4 B trigger - $\nearrow$ Edge

In this mode time base B will not start immediately after the set delay time has elapsed, but will be only set ready, waiting for a signal trigger. This has the advantage that any jitter is removed, but the delay time adjustment will now only have the effect that the time base B display will jump from signal period to period. In this setting a positive slope will trigger.

The (trigger) LEVEL A/B [19] knob will set the trigger level for B. Only normal triggering and DC coupling are possible. All parameters of time base A remain stored and preserved. (LEVEL, auto or normal, Slope, coupling). In addition to the delay time ("Dt:...") also the B trigger parameters are shown in the readout: "BTr:slope, DC". In "Search" mode the trigger point symbol will be preceded by "B". As mentioned changing the delay time will not cause a continuous move of the intensified portion of the time base A display and the time base B display, but jumps from signal period to period.

If the trigger level symbol of time base B is shifted outside the signal representation by time base A there will be no triggering of time base B any more and thus no time base B display. The same holds in time base B only mode.

### 30.1.5 B trigger - $\searrow$ Edge

Except for the negative edge the function is identical to the one described above [30.1.4].

### 30.1.6 B trigger - OFF

Time base B will be started at the end of the delay time set. The delay time can be changed continuously in this mode and can be seen as the intensified sector of the time base A display. The disadvantage here is that with very long delay times, jitter of the time base B display may occur. As time base B is not operated in the signal triggered mode, the controls for time base B trigger will be disabled.

### 30.1.7 A variable - On Off

If "On" was selected the TIME/DIV-SCALE-VAR knob [28] will function as variable control for the time base A speed. Only in time base A only mode will this option be available in the menu.

For a full description see "28.1.3 Variable".

### 30.1.8 B variable - On Off

If "On" was selected the TIME/DIV-SCALE-VAR knob [28] will function as the time base B variable control. For a full description see "28.1.3 Variable".

### 30.1.9 Holdoff ...%

In this mode the hold off time may be selected from 0 to 100 % with the INTENS knob [2]. Values > 0 extend the waiting time after a sweep before a new one can start and decrease thus the repetition rate which may darken the display. This is indicated by the HOLD OFF-LED [25] lighting up. The hold off time is only valid for time base A. Further information can be found in the section "Hold off adjustment" in the chapter "Triggering and time bases".

## 30.2. Digital mode

In the "Zoom" menu the following time base functions are available:

### 30.2.1 Off

In "Zoom Off" condition only time base A is active. The readout will thus only show "A..." in the top left corner. The speed can be set with the TIME/DIV-SCALE-VAR knob [28].

### 30.2.2 Search

Part of the time base A display will be intensified and this portion will also be displayed expanded over the full screen, if neither reference nor mathematic signal display is activated. With the HORIZONTAL knob [27] the intensified sector and the expanded display can be shifted provided that the pushbutton X POS DE-

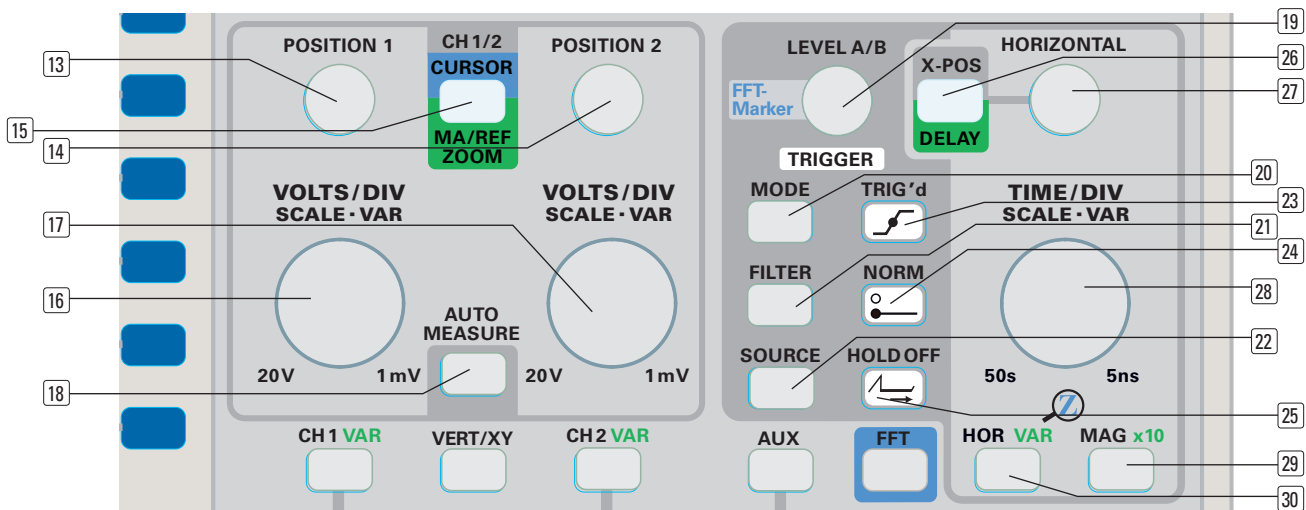

LAY 26 is illuminated which means "Delay". The length of the intensified sector is determined by the speed of the Z time base. The Y position of both displays is identical so they are written one over the other. In order to separate them for better readability an artificial Y offset may be added to the Z time base display. Press the pushbutton CH1/2-CURSOR-MA/REF-ZOOM 15 to call the menu "Pos./Scale".

Then press the function pushbutton "Zoom". Now the POSITION 1 knob will function as Y position control for time base Z. As this only makes sense in "Search" mode it is unavailable in others.

The signal(s) Y position is independent from the time base (A and Z) used for display. As a result the signal displays of time base A and Z are not easily evaluated, as both signal displays are shown in the same Y position. This can be avoided by changing the Z trace position in the following way: Press the CH1/2-CURSOR-MA/REF-ZOOM-pushbutton 15 to call the "Pos./Scale" menu. Then press the function key "Zoom" so that the POSITION 1 knob 13 becomes the trace separation control (see 13.1.5 Y Position - 2<sup>nd</sup> time base). As there is only a demand for trace separation in "Search mode" this function is only offered in this time base mode.

### 30.2.3 Zoom only

Only the Z time base will be displayed in this setting. Thus the readout in the top left position only displays the "Z...." time deflection coefficient and the TIME/DIV-SCALE-VAR knob only affects time base B.

### 31 CH1 VAR (pushbutton)

This pushbutton opens the "CH1" menu which contains the following options referring to CH1 34 and the signal on CH1.

#### 31.1. AC DC

Pressing the pushbutton will switch from AC to DC or vice versa. The mode selected will be shown in the readout following the sensitivity setting: ~ is for AC and = is for DC.

##### 31.1.1 DC coupling

The signal will be directly coupled, from the BNC connector via the attenuator to the vertical amplifier. The input resistance is 1 MΩ in all positions of the attenuator.

##### 31.1.2 AC coupling

A capacitor is inserted between the BNC connector and the

attenuator, blocking the DC content of the signal and creating a low frequency cut off at approx. 2 Hz. This will affect the shape and amplitude of signals with low frequency content. If the DC content of the signal, or the duty cycle of pulses changes the capacitor will charge or discharge, and this will cause a momentary Y shift of the display.

#### 31.2 Ground (GND) On Off

The pushbutton will either connect the amplifier to the signal or to ground. If set to Ground the readout will show a ground symbol following the sensitivity setting, where the coupling symbol was before. In the Ground position and with automatic triggering a trace will be visible, this is handy for setting the Y position e.g. to the screen centre without disconnecting the signal. After switching back to the signal its amplitude can now be determined with respect to the formerly set zero reference.

The 0 V (Ground) position can but must not be determined in the way described above, as the readout shows a symbol (⏏) for 0 V which is displayed 4 mm left of the vertical graticule line in the screen center.

#### 31.3 Invert On Off (not in analog XY mode)

The pushbutton will alternate between not inverted and inverted. An inverted signal will be indicated in the readout by a bar above the channel symbol. The trigger signal taken from an input will not be affected.

#### 31.4 Probe

The menu display depends on whether a probe with automatic dividing factor identification is connected or not. The actual parameters are taken into account in the display of voltage measurement.

**31.4.1** If a HAMEG probe with automatic identification is connected, the readout shows "Probe" in normal intensity and below the dividing factor (e.g. \*10).

**31.4.2** If the "CH1" menu is called, "Probe", if a probe without identification is connected, the last set dividing factor and the INTENS knob 2 symbol are displayed. Pressing the allocated function key causes "Probe" to be displayed with higher intensity and the FOCUS TRACE MENU pushbutton 3 to light constantly. Then the INTENS knob 2 can be used to select a dividing factor which should accord with the connected probe.

#### 31.5 Variable On Off

On condition "On" the CH1 VAR pushbutton 31 is lit. Then the

VOLTS/DIV-SCALE-VAR knob **16** CH1 serves as variable control that allows change of the deflection coefficient continuously over the complete range and consequently the signal display height. If uncalibrated, a ">" sign is displayed by the readout in front of the deflection coefficient; if calibrated a ":" sign. The results of voltage measurement are labelled in the same way.

After switching over from "Variable on" to "Variable off" with the function key, the VOLTS/DIV-SCALE-VAR knob **16** returns to 1-2-5 sequence switching and CH1 to calibrated condition.

**32 VERT/XY** (pushbutton)

This pushbutton switches the "vertical" menu on/off. This menu allows you to select the operating modes of the vertical amplifiers.

**32.1 CH1**

If "CH1" is selected only CH1 will be turned on, the mode is Yt. Also the readout will only display the parameters of CH1. (sensitivity, inverted/not inverted, coupling.) Although CH2 will not appear in the readout it may be used e.g. as a trigger input. Its controls are active but are not shown.

**32.2 CH2**

If "CH2" is selected only CH2 will be active, it is Yt mode, and only its parameters will be shown in the readout. Although CH1 will not appear in the readout it may be used e.g. as a trigger input. Its controls are active but are not shown.

**32.3.1 DUAL trace alt./ chop**

In dual trace mode both channels are turned on and the parameters of both are shown in the readout. Between the sensitivity indications there is an indication whether alternate "alt." or chopped "chp" mode is active. Normally, the mode will be automatically set by the time base speed selection, but it may be directly set using the function pushbutton. For time base speeds of 500 ms/cm to 500  $\mu$ s/cm, chopped will be used, from 200  $\mu$ s/cm to 50 ns/cm alternate. This refers to un magnified time bases. Alternate is the preferred mode, at any time one channel is displayed for a full sweep, after each sweep the other channel has its turn. At slow sweep speeds this will cause annoying flicker, at still slower ones the channel switching becomes visible. Here, the chopped mode steps in, both channels are switched at some high frequency so they are both visible at any sweep speed. This however, is not appropriate for fast sweep speeds as the switching may become visible and may interfere with the proper signal display.

**32.3.2 DUAL (digital mode).**

In digital mode there is an A/D converter for each channel so

both are measured simultaneously. Hence no channel switching is necessary and no information pertaining to it is shown.

**FFT: DUAL mode will not be offered in combination with FFT.**

**32.4 ADD**

In ADD mode the signals of both channels are algebraically added and displayed as one sum signal. The Y position can be changed with both position controls. If one channel is inverted the difference will be displayed. Only one "0V" symbol will be shown in the readout. The ADD mode will be indicated by placing a "+" symbol between the sensitivity indications of both channels.



**In digital mode "1+2" will be displayed at the end of the trace.**

Please note that the results of auto and cursor measurements in this mode will only be correct if the sensitivities of both channels are identical, otherwise the readout will show "CH1<>CH2".

As the trigger signals are taken off the inputs and not from the added signal there is no true reference for the trigger point symbol, the symbol will thus be switched off in analog mode. However, the LEVEL A/B control **19** is active. In digital mode a trigger time symbol is displayed one line above the lowest graticule line to indicate the trigger time position along the signal and thus can only be moved horizontally.

**FFT: ADD mode will not be offered in combination with FFT.**

**32.5 XY**

In this mode CH1 will move the trace in X direction, hence the readout will show "CHX..", CH2 will move the trace in Y direction, hence "CHY..." will be shown rather than "CH2..."

As the time bases are not involved in XY no time base related information will be shown. Also the trigger circuits are disabled so no trigger information is shown either. The magnifier MAG x10 **29** is disabled. The "0-Volt" symbols will be shown as triangles at the right hand graticule and above the sensitivities. Both the HORIZONTAL **27** or the POSITION 1 **13** knobs will move the trace horizontally. The Y position is controlled by the POSITION 2 knob.

**32.5.1 Analog mode**

The CH1 signal can not be inverted, there is hence no menu item in the CH1 menu (CH1 VAR pushbutton **31**). The TIME/DIV-SCALE-VAR knob **28** is disabled.

Please note that the bandwidths and phase differences in XY analog and digital mode differ considerably so there may be changes in the signal display when switching the mode.

**32.5.2 Digital mode**

The readout will indicate the sampling rate with which the A/D converters digitise the input signals. The appropriate sampling rate must be set depending on the signals and can be selected

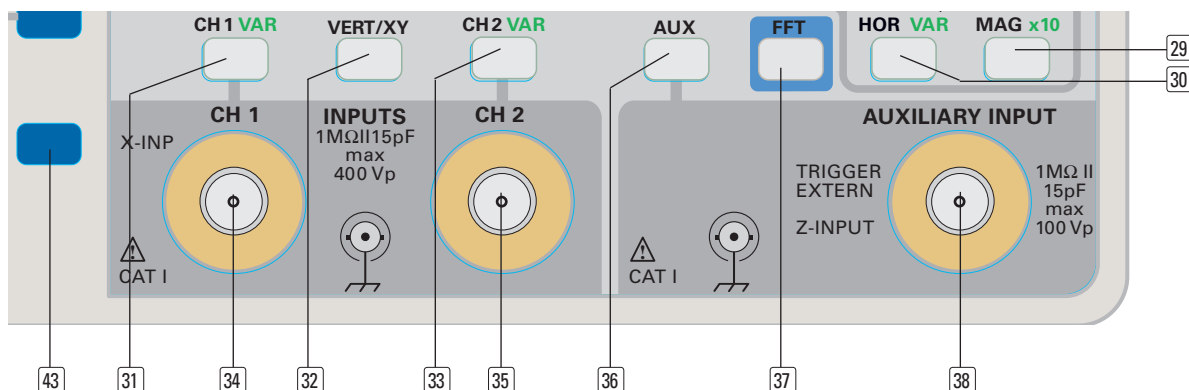

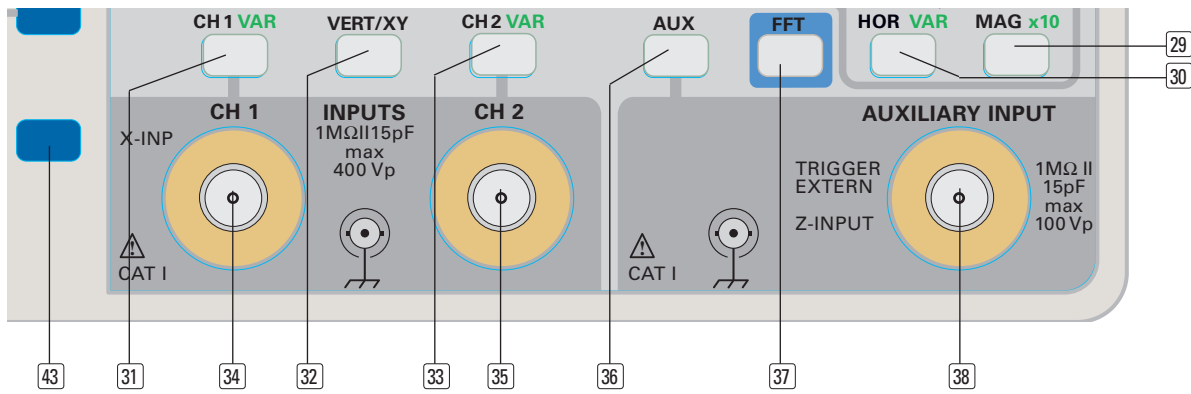

with the TIME/DIV-SCALE-VAR knob, although the time bases are disabled. With high sampling rates there may be gaps in Lissajous representations. With too low sampling rates the display may no longer allow you to determine the frequency relationship of the signals.

It is recommended first to look at the signals in DUAL mode and to set the sampling rate such that at least one signal period will be displayed. Then XY should be selected. In XY digital mode both channels may be inverted.

**FFT: XY mode will not be offered in combination with FFT.**

### 32.6 Bandwidth Full/20 MHz

This pushbutton will select full or 20 MHz bandwidth.

- **Full:**  
Full bandwidth will be the one given in the specifications.
- **20 MHz:**  
Provided measuring modes allow full bandwidth. This can be reduced to 20 MHz (-3 dB) in order to attenuate high frequency noise e.g. The readout will show BWL = bandwidth limited. The bandwidth limitation affects both channels and pertains to analog and digital mode. In XY digital mode the limitation is equal to Yt mode. In XY analog mode the limitation affects only CH2.

### 33 CH2 VAR (pushbutton)

This pushbutton opens the CH2 menu which offers the following options:

#### 33.1 AC DC

The pushbutton will alternate between AC and DC coupling. The readout shows a "~" or "=" symbol after the sensitivity indication.

##### 33.1.1 DC coupling

The signal will be directly coupled to the input amplifier via the BNC connector (35) and the input attenuator. The input resistance of the scope is a constant 1 MΩ irrespective of the sensitivity selected.

##### 33.1.2 AC coupling

A capacitor is inserted between the BNC connector and the attenuator, thus the DC content of the signal is blocked and a high pass with a lower cut off frequency of approx. 2 Hz is created. Low frequency signals will thus be more or less differentiated, hence their shape and amplitude affected. If the DC content of the signal changes, e.g. the duty cycle of pulses, the capacitor must charge or discharge. This will cause a momentary Y shift of the display.

#### 33.2 Ground (GND) On Off

The pushbutton will either connect the amplifier to the signal or to ground. If set to Ground the readout will show a ground symbol following the sensitivity setting where the coupling was indicated

before. In the Ground position and with automatic triggering a trace will be visible, this is handy for setting the Y position of it e.g. to the screen centre without disconnecting the signal. After switching back to the signal, its amplitude can now be determined with respect to the formerly set zero reference.

The 0 V (Ground) position can but must not be determined in the way described above, as the readout shows a symbol (⊥) for 0 V which is displayed 4 mm right of the vertical graticule line in the screen center.

#### 33.3 Invert On Off

The pushbutton will alternate between not inverted and inverted. An inverted signal will be indicated in the readout by a bar above the channel symbol. The trigger signal taken from an input will not be affected.

#### 33.4 Probe

The menu display depends on whether a probe with automatic dividing factor identification is connected or not. The actual current parameter are taken into account at the display of voltage measurement.

**33.4.1** If a HAMEG probe with automatic identification is connected, the readout shows "Probe" in normal intensity and below the dividing factor (e.g. \*10).

**33.4.2** If the "CH2" menu is called, "Probe", the last set dividing factor and the INTENS knob symbol are displayed if a probe without identification is connected. Pressing the allocated function key cause "Probe" to be displayed with higher intensity and the FOCUS TRACE MENU pushbutton (3) constantly lit. Then the INTENS knob (2) can be used to select a dividing factor which should accord with the connected probe.

#### 33.5 Variable On Off

On condition "On" the CH2 VAR pushbutton (33) light. Then the VOLTS/DIV-SCALE-VAR knob (17) CH2 serves as variable control that enables to change the deflection coefficient continuously over the complete range and consequently the signal display height. If uncalibrated a ">" sign is displayed by the readout in front of the deflection coefficient; calibrated a ":" sign. The results of voltage measurement are labelled in the same way. After switching over from "Variable on" to "Variable off" with the function key, the VOLTS/DIV-SCALE-VAR knob (17) returns to 1-2-5 sequence switching and CH2 to calibrated condition.

### 34 INPUT CH1 (BNC connector)

This is the CH1 signal input connector. In Yt mode it is a Y input, in XY mode it is the X signal input. The connector housing is connected to the instrument housing and thus to safety ground. The ring around the connector is the probe identification contact, no voltage may be applied here.

**35 INPUT CH2** (BNC connector)

This is the CH2 signal input connector. It is a Y input in Yt and XY mode. The connector housing is connected to the instrument housing and thus to safety ground. The ring around the connector is the probe identification contact, no voltage may be applied here.

**36 AUX** (pushbutton)

This pushbutton belongs to the AUXILIARY INPUT **38**. Depending on the current operating mode a menu may open after pressing.



**Attention!**

**This pushbutton has no function in analog and digital mode if "External" is selected in the trigger SOURCE **22** menu and does not open a menu.**

**36.1 Analog mode**

**36.1.1** The AUXILIARY INPUT serves as an input for external trigger signals if after pressing the SOURCE **22** pushbutton the function "External" has been chosen.

**36.1.2** If "External" triggering was not selected the menu "Z Input" will open up. If "Off" is chosen the AUXILIARY INPUT has no function. If "On" is chosen it will function as Z input i.e. intensity modulation input. This input is destined for TTL signals, a voltage of > 1 Vp will turn off the trace. The AC DC function key is for Z input coupling selection.

**36.2 Digital mode**

In digital mode the AUX pushbutton is disabled and the AUXILIARY INPUT **38** serves only as an external trigger input.

**37 FFT pushbutton** (digital mode only)

Pressing the FFT pushbutton switches over to FFT, if digital Yt mode is present.

**Note:** In this state FFT mode can only be left by switching over to analog mode. If digital mode is not to be left, please press the FFT pushbutton again to display the FFT menu which offers an Off function. Pressing the FFT pushbutton once again cause the FFT menu to be displayed.

**Note:** The signal can be input at CH1 or CH2. After pressing the VERT/XY pushbutton **32** the channel can be selected. If DUAL was present before, when switching to FFT, the channel that previously served as trigger source is selected.

**37.1 Window**

There are different "windows" available that cause different signal data calculation and their display on the frequency axis.

Window	Criteria	Optimal for measurement of
Hanning / Hamming	Good / ideal frequency resolution but worse amplitude resolution as at rectangle. Hamming offers a slightly better frequency resolution than Hanning.	Sine wave, periodical signals as well as narrow band static noise; transients or burst.
Blackman	Good amplitude, perfect frequency resolution.	Mono frequent signals for detecting harmonics of higher order.
Rectangle	Best frequency resolution and lowest amplitude accuracy.	Transients and bursts, settling time analysis; sine wave signals with equal amplitudes and stable frequency; broadband static noise with relatively slowly varying spectrum.

After pressing the function key, the required "window" function (Hamming, Hanning, Blackman, Rectangle) can be determined by the INTENS knob **2**. Please refer to the table below.

**Note:**

The FFT frequency resolution is the quotient of sampling rate and the number of FFT points (4 kPts). At a constant number of FFT points, the resolution is proportionally better as the sampling rate is lowered. The Nyquist frequency is the highest frequency a real time digital oscilloscope can measure without aliasing. This frequency is half the sampling frequency (sampling rate). In case of higher frequencies the number of samples is too low. If the sampling frequency (rate) is possibly too low, the readout displays ALS?.

**37.2 Mode**

The desired signal capture mode can be determined by the INTENS knob **2** after pressing the function key. The following modes are available:

**37.2.1 Refresh**

The signal capture is performed in real time refresh mode. The result is displayed on the frequency axis (Yf).

**37.2.2 Envelope**

As in Yt mode frequency maxima and deviation are displayed on the frequency axis (Yf).

**37.2.3 Average**

Shows the result of signal capturing processes after FFT calculation and averaging.

**37.2.4 Number**

Determines the weighting accuracy of the FFT calculations in the following averaging process. Numbers between 2 and 512 can be chosen by aid of the INTENS **2** knob which are displayed by the readout (e.g. avg#256). The accuracy increases with higher numbers but requires more time. Averaging enables to reduce amplitude changes (noise) and frequency changes (jitter) in the display.

**37.3 Scale**

The TIME/DIV-SCALE-VAR knob enables up to 20 fold X expansion of the total spectrum display. This means that in case of a span of e.g. 500 MHz, the span is reduced to 250 MHz if 2 fold expansion is active; or 25 MHz span as the result of a 20 fold expansion. The current center frequency setting is not affected by scale factor changes.

On condition scale (X expansion), only a fraction of the spectrum is displayed. The fractions lost can be made visible by turning the HORIZONTAL knob, changing the center frequency setting.

**37.4 dBV V(rms)**

The amplitude unit can be selected by pressing the function key and will be displayed with intensified brightness.

V<sub>rms</sub> refers to 0 Volt (linear scaling of the Y axis) which is indicated by the reference symbol at the left border of the graticule.

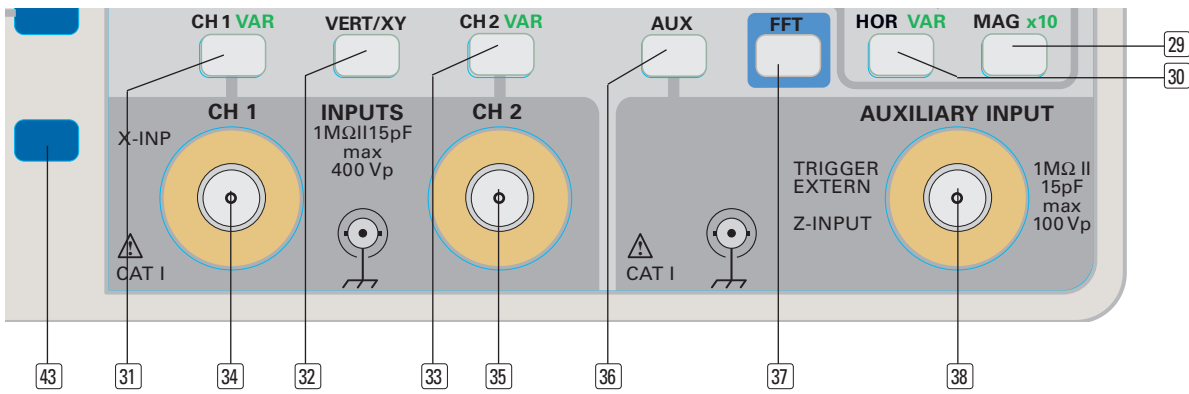

0 dBV equals 1 Volt (logarithmic scaling of the Y axis). If the reference symbol is 5.5 cm (div.; typically) above the noise level and is the current scaling 20dB, the noise level is 110dB (typically) below 1 Volt.

**37.5 Off**

The function key "Off" switches over from FFT to Yt mode and the FFT menu off.

**38 AUXILIARY INPUT (BNC connector)**

In analog mode this BNC connector serves as an input for external trigger or Z axis (intensity modulation) input. In digital mode it can only be used as a external trigger input.

The connector housing is connected to the instrument housing and thus to safety ground. The ring around the connector is the probe identification contact, no voltage may be applied here.

**39 PROBE ADJ. (connector)**

The square wave signal from this socket has an amplitude of 0.2 V<sub>pp</sub> and serves for frequency compensation of 10:1 probes. The signal frequency can be determined in the menu "Utilities" that is present after pressing PROBE ADJ.-pushbutton 41. Further information may be found in the section "Probe adjustment and use" in the chapter "Operation and presetsings".

**40 PROBE ADJ (pushbutton)**

Pressing this pushbutton opens the menu "Utilities".

**40.1 COMP.Tester On Off**

Component Tester mode (On) is only possible in analog mode which is automatically set.

In this mode only a shorter trace, "Component Tester" and measurement parameter (test voltage and maximum test current) are displayed. The sockets marked "COMP. TESTER" serve as inputs.

Pressing the function key "off" switches back to the last used operating conditions.

**40.2 Calibrator**

The function keys 1 kHz and 1 MHz enable the selection of the square wave signal frequency available at the PROBE ADJ connector.

**40.3 Information**

This function key opens the item Utilities Information which offers information about the oscilloscope.

**40.4 USB Stick**

If "None" is displayed, no USB flash drive is connected at the "USB Stick" 42. After connecting a USB flash drive "None" is replaced by hints on the submenus Save and Recall that can be opened by pressing the assigned function keys.

When the menu Utilities is not displayed, it opens automatically when a USB flash drive is connected. with the USB Stick connector 42.

**40.4.1 USB Stick Save**

**40.4.1.1 Front Panel (current oscilloscope parameters)**

The current parameters are saved on the USB flash drive by pressing the function key "Save as SET00000". Afterwards the display shows the name of the next memory (e.g. SET00001) in which parameter can be saved.

**40.4.1.2 Screenshot**

Screenshot can be saved in bit map format by pressing the function key "Save as SCR00000". Afterwards the display shows the name of the next memory (e.g. SCR00001) in which bit map data can be saved.

**40.4.1.3 Wave**

After the selection of "Source" (channel) and "Type" (REF = reference memory; CSV (data format) = comma separated value; ASC (ASCII) or BIN (binary format) the sector "Save as WAV00000 shows the memory name in which the data are stored. Afterwards the display shows the name of the next memory (e.g. WAV00001) in which wave form data can be saved.

**40.4.2 USB Stick Recall**

**40.4.2.1 Front Panel (stored oscilloscope parameters)**

Press "Recall" if only one parameter set is stored in the USB flash drive.

If more then one parameter set is stored in the USB flash drive, the function key "File" together with the rotary encoder symbol are displayed. Pressing "File" opens a "Selection" box opens where different memory place numbers can be selected by aid of the INTENS knob 2.

Press the "Recall" function key to copy the selected signal (wave) into the selected oscilloscope reference memory.

**40.4.2.2 Reference Memory x (rotary encoder symbol)**

Press the "Reference" function key and turn the INTENS knob 2 to select one of 9 oscilloscope reference memories into which the signal (wave) stored in the USB flash drive shall be copied. If more than one signal (wave) is stored in the USB flash drive, the function key "File" together with the rotary encoder symbol

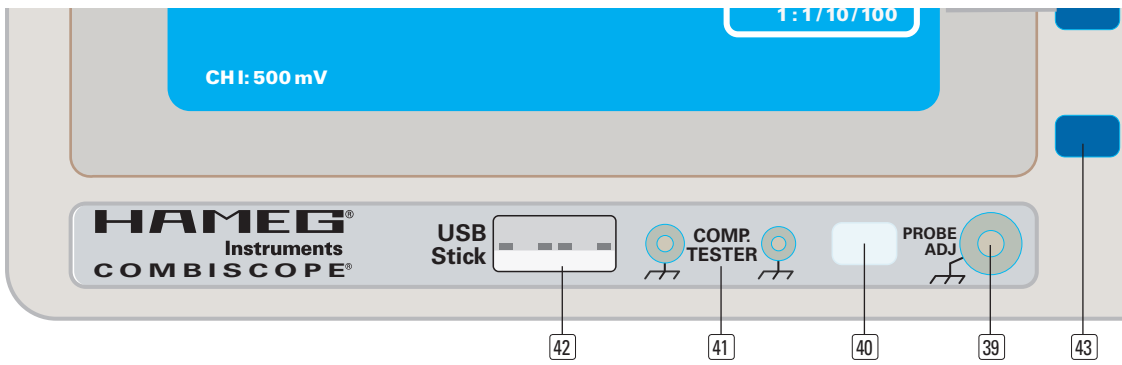

are displayed. Pressing "File" opens a "Selection" box where different memory place numbers can be selected by aid of the INTENS knob [2](#).

Press the "Recall" function key to copy the selected signal (wave) into the selected oscilloscope reference memory.

#### [41](#) **COMP. TESTER** (sockets)

Both 4 mm diameter sockets serve as a two pole input for component test. Further information can be found under section "Component Tester".

#### [42](#) **USB Stick** (USB flash drive connector)

After a USB flash drive has been connected, the LED in the USB flash drive briefly blinks and the menu "Utilities" opens. Further information can be found under PROBE ADJ [41.4](#): USB Stick.

#### [43](#) **MENU OFF** (pushbutton)

Switches the menu display off or one step back in the menu hierarchy.