



Digital Multimeter

DM-330SRS Digital Multimeter Operation manual

 EZ Digital Co.,Ltd.

**Test Equipment
Depot**

1-800-517-8431

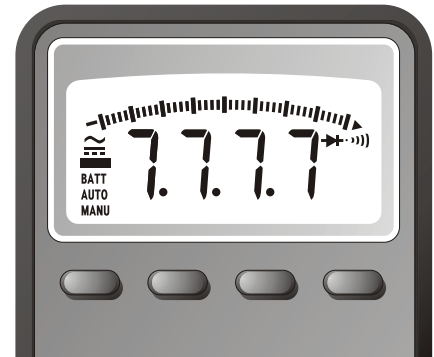



Digital Multimeter

DM-330SRS Digital Multimeter Operation manual

 EZ Digital Co.,Ltd.

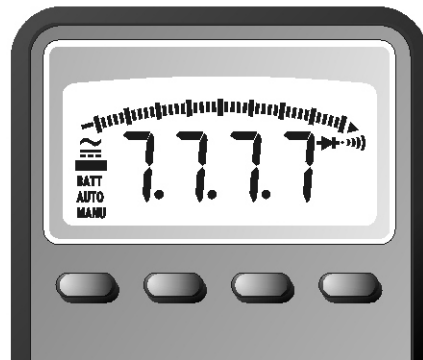

WARNING

Before using the meter, you must read the following safety information of Maximum input specification carefully.

- V measurements : Below **1000VDC, 750VAC** RMS
- mA measurements : Below **500mA**(Fuse rating 250V)
- 10A measurements : Below **10A**(Fuse rating 250V)
- Ω measurements : Below **600VAC/DC**(1 minute)
-  measurements : Below **600VAC/DC**(1 minute)
- Capacitance measurements : Below **600VAC/DC**
- Hz measurements : Below **250VAC/DC**
- BAT : Don't input the any voltage, current but battery voltage.

If you don't follow the safety information, **DMM SET** may be damaged.

And, it can cause a roaring noise or a fire.

CONTENTS

TITLE	PAGE
INTRODUCTION -----	1
MULTIMETER SAFETY-----	2
FEATURES -----	4
HOW TO USE THE METER -----	5
Input Terminals -----	5
Function Selector Rotary Switch-----	5
Pushbuttons -----	8
Digital display -----	9
APPLICATIONS -----	-10
Measuring Voltage (AC/DC) -----	-10

(continued on page ii)

CONTENTS, continued

TITLE	PAGE
Measuring Current (AC/DC) - - - - -	11
Measuring Resistance - - - - -	12
Transistor hFE Test - - - - -	13
Diode Test - - - - -	14
Continuity Test - - - - -	15
Battery Test - - - - -	16
Measuring Frequency - - - - -	17
Measuring Capacitance - - - - -	19
Inner Battery Voltage Check - - - - -	20
MAINTENANCE - - - - -	21
Calibration/ Replcement - - - - -	21
Battery & Fuse Replcement - - - - -	22
SPECIFICATIONS - - - - -	23
Specifications (DM-331, 332) - - - - -	23
Specifications (DM-333, 334) - - - - -	26

INTRODUCTION

NOTE

*All material in this manual applies to the **DM-330SRS** unless otherwise indicated.*

This meter has been designed and tested according to EN 61010-1, Safety Requirements for Electronic Measuring Apparatus.

This manual contains information and warnings which must be followed to ensure safe operation and retain the meter in safe operation and retain the meter in safe condition.

HOLSTER (Option)

The meter comes with a snap-on holster that absorbs shocks and protects the meter from rough handling. You can also hang the meter on your belt for easy viewing while probing. The test leads may be snapped into the holster that allows you to hold both the meter and probe tip with one hand.

WARNING

READ "MELTIMETER SAFETY" BEFORE USING THE METER.

Your EAD Digital Multimeter (also referred to as the meter) is a handheld instrument that is designed for use in the field, laboratory and at home.

The meter combines the precision of a digital meter with the speed and versatility of a high resolution.

The meter is powered by a 1.5Vx2 battery and has a rugged case sealed against dirt, dust and moisture.

A snap-on holster protects the meter from rough handling.

After unpacking the meter, if you notice that the meter is damaged or something is missing, contact the place of purchase immediately. Save the shipping container and packing material in case you have to reshipe the meter.

The higher input voltage than the maximum one can cause the roaring noise by the spark gap included for protection.

MULTIMETER SAFETY

MULTIMETER SAFETY

Before using the meter, read the following safety information carefully. In the manual the word "WARNING" is used for conditions and actions that pose hazards to the user, the word "CAUTION" is used for conditions and actions that may damage your meter.

The symbols shown in Figure 1 are used internationally to denote the electrical functions and conditions indicated.









	DANGEROUS VOLTAGE		GROUND
	AC-ALTERNATING CURRENT		SEE EXPLANATION IN MANUAL
	DC-DIRECT CURRENT		DOUBLE INSULATION
	EITHER DC OR AC		FUSE

Figure 1. international Electrical Symbols

SAFETY DESIGNED

This meter has the feature that warns the dangerous mismatching between rotary switch's mode selection position and jack terminal used, Buzzer sound if rotary switch is not set to Amp mode (10A DC/AC) during 10A terminal which a detector is built in, plugged in by test lead. To avoid accidentally applying voltage to 10A terminal, verify that red test lead is connected to V input terminal before making voltage measurement. This restriction ensures protection against burns in the event that voltage is accidentally applied between 10A and COM terminals. v/Ω terminal is colored in red, COM terminal in black and 10A terminal in Red to be recognized with easy (refer to Fig.2).

- Avoid working alone.
- Inspect the test leads for damaged insulation or exposed.
- Select the proper function and range for your measurement.

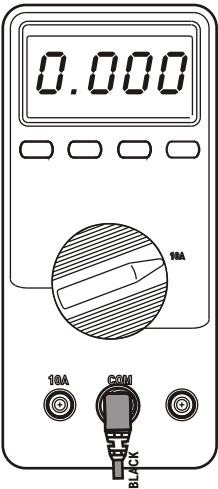

(mismatching)

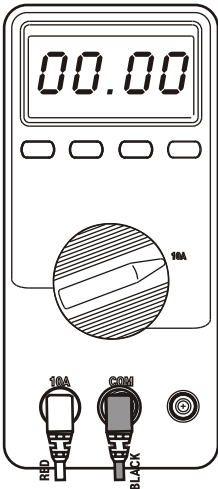

(Good)

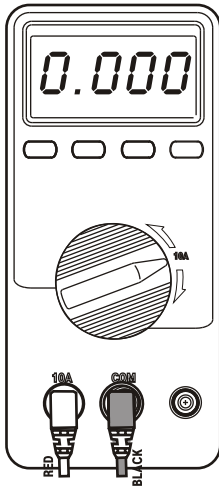

(mismatching)

Figure 2

- * Using Effect (A): No plug in 10A JACK terminal. (Range selector : except 10A position)
- (B): Performance good Measurement.
- (C): Buzzer sound.

FEATURES

- Disconnect the live test lead (Red) before disconnecting the common test lead (Black).
- Follow all safety procedures for equipment being tested. Disconnect the input power and discharge all high voltage capacitors through a protective impedance before testing in the Ω and \rightarrow functions.
- When making a current measurement, turn the power off before connection the meter in the circuit.
- Check the meter fused before measuring current transformer secondary or motor winding current. An open fuse may allow high voltage build-up, which is potentially hazardous.
- To take a measurement, use the test lead probes to make the proper contacts. Remember, insert the meter in the circuit in parallel for voltage and in series for current measurements.

WARNING

TO AVOID ELECTRICAL SHOCK OR DAMAGE TO THE METER, DO NOT APPLY MORE THAN 1000V BETWEEN COMTERMINAL AND EARTH GROUND.

TO AVOID ELECTRICAL SHOCK, USE CAUTION WHEN WORKING ABOVE 60V DC OR 30V AC RMS, SUCH VOLTAGES POSE A SHOCK HAZARD.

FEATURES

- 3 $\frac{1}{2}$ Digit

└	4000 count LCD(DM-331, DM-332,DM-334)
└	3200 count LCD(DM-333)
- Measurement rate

└	Digital : 2 times/sec
└	Capacitance : 1 times/sec
- Different colors of input terminals
- Auto power off

└	About 30min(DM-331, DM-332, DM-334)
└	About 10min(DM-333)
- Low battery indication
- Protection for input overload
- Dual-slop integration A/D converter system.
- Over range indication : Most-significant digit flickered "OL" displayed (only, DM-333)
- Battery life : Typical 500HRS with a regular battery
- Temperatures
 - Operation : 0°C ~ 40°C (below 80% RH)
 - Storage : -10°C ~ 60°C (below 70% RH)
- Guaranteed accuracy : 23°C \pm 5°C

SAFETY

Certified by TÜV Rheinland.

- EMC

└	EMI : EN50081-1
└	EMS : EN50082-1
- Safety : EN61010-1
 - Over voltage cat. II
 - pollution deg. II

HOW TO USE THE METER

This section describes your meter and how to use it, For ease of reference, each description is numbered and keyed the illustration in page 29, 30 of this manual.

Input terminals

Item ①~④ describe the input terminals and the different colors of input terminal allow you to have easy operation. (See Table 1 for overload limits.)

① 10A Amperes Input Terminal

For current measurements (AC or DC) up to 10A continuous when the function selector switch is in the 10A position.

② COM Common Terminal (Black color)







Return terminal for all measurements.

Do not apply more than 1000V between The COM terminal and Earth ground.

③ v/Ω Volts, Ohms, Continuity, Current(Ma), BAT, Frequency, CAP, Diode test input Terminal (Red Color)

④ SOCKET Transistor hFE input terminal
Function Selector Rotary Switch

⑤ item ⑤ describes functions that are selected by setting the rotary switch. The meter is ready for normal operations and will respond to the rotary switch and pushbuttons.

	Volts AC		Volts DC
	Amperes AC		Amperes DC
Ω	Resistance	BAT	Battery Test
	Diode Test	hFE	TR hFE Test
	Beeper Sound Continuity Test		
CAP	Capacitance Test	Hz	Frequency Test

HOW TO USE THE METER

INPUT TERMINALS AND LIMITS

Table 1. Input Terminals and Limits(DM-310SRS)

FUNCTION	INPUT TERMINALS		MIN DISPLAY READING		MAX DISPLAY READING		MAXIMUM INPUT
	RED	BLACK	DM-331 332,334	DM-333	DM-331 332, 334	DM-333	
V	V/Ω	COM	0.1mV	0.1mV	1000V	1000V	1000VDC,750VAC
10A	10A	COM	0.01A	0.01A	10.00A	10.00A	10A/250V
mA	V/Ω	COM	1μA	1μA	399.9mA	325.9mA	400mA/250V
Ω	V/Ω	COM	0.1Ω	0.1Ω	39.99MΩ	32.59MΩ	600VAC/DC(1min)
CAP	V/Ω	COM	0.01 nF (DM-332)	-	39.99μF (DM-332)	-	600VAC/DC(1min)
Hz	V/Ω	COM	10Hz (DM-332,334)	-	999.9kHz (DM-332,334)	-	250VAC/DC
BAT	V/Ω	COM	0.001V (DM-332,334)	-	39.99V (DM-332,334)	-	Do not Apply any Voltage or Current(only Battery)
	V/Ω	COM					600VAC/DC(1min)

Pushbuttons

Items ⑥ ~ ⑫ describe how to use the pushbuttons.

⑥ POWER ON/OFF (DM-331, 332)

Press the power button to turn on the meter.

⑦ MANUAL RANGING (DM-333, 334)

Press RANGE to select the manual range mode, then the "AUTO" annunciator is Disappear (the meter remains in the range it was in when manual ranging was selected).

In the manual range mode, each time for press range button, the range increments, and a new value is displayed. To exit the manual range mode and turn to the auto ranging, press and hold down range mode and turn to the auto ranging, press and hold down range sw for 2 seconds the "AUTO" annunciator turns back on.

⑧ MIN/MAX(DM-331, 332, 334)

Press MIN/MAX button to enter MIN/MAX recording mode. The MIN/MAX are then reset to the present input in the MIN/MAX recording mode, the MIN/MAX are stored in memory.

Push MIN/MAX button to cycle through the MIN/MAX and present readings at normal record speed. Charges to the voltage, current or resistance inputs that last at least 100 milliseconds are recorded.

⑨ HOLD(display hold)

Press hold sw to toggle in and out of the touch hold mode.

In the touch hold mode, the "HOLD" annunciator is displayed and the last reading is hold on the display.

When a new stable reading is detected, the beeper emits a tone, and the display is automatically undated.

In the MIN/MAX recording mode, press "HOLD" to stop the recording of reading,

press "HOLD" to stop display, press "HOLD" again to start it.(DM-331, 332, 334)

⑩ DC/AC (DM-332, 333, 334)

Press Push the switch to measure AC voltage or AC current in the voltage or current mode.

HOW TO USE THE METER PUSHBUTTONS





⑪ REL(relative reading) (DM-331)

Press REL to enter the relative mode, zero the display, and store the displayed reading as a reference value.

The relative mode annunciator "REL" is displayed.

Press and hold down REL for 2 seconds to exit in the relative mode, the value shown on the LCD is always the difference between the stored reference value and the present reading. for example, if the reference value is 15.00V and the present reading is 14.10V, the display will indicate -0.90V. If the new reading is the same as the reference value, the display will be zero.

⑫ (DM-333)

Press push button switch to measure  or  in the   mode.

* Auto Power off

The meter will automatically shut itself off after approximately 30min(DM-331, 332, 334) and 10min (DM-333) after power on.

The meter can be turned back on by pushing Hold key switch (DM-331, 332, 334)and any key (DM-333).

Digital and Analog display

1) DIGITAL DISPLAY

Digital readings are displayed on a 4000 count or 3200 count display with polarity indication and automatic point placement. When the meter is turned on, all display segments and annunciators appear briefly during a selftest.

2) ANALOG DISPLAY

The analog display provides an analog representation of readings and updates 20 times per second but it doesn't operate at the capacitance function and the frequency count mode.

3) **AUTO** AUTO-RANGE (DM-333, 334)

The meter is in the auto-range mode and will automatically select range with the best resolution.

The meter powers on in auto-range mode.

4) **—** NEGATIVE POLARITY

Automatically indicates negative inputs.

When REL is enabled, indicates negative requests of math calculations.

5) **•••** BEEPER

continuity test is enabled.

6) **REL** RELATIVE MODE(DM-331)

The value displayed is the difference between the present measurement and the previously stored reading.

Probe resistance compensation for resistance measurements can be achieved by using this mode.

7) **MIN/MAX** MODE

MIN/MAX value in MIN/MAX recording mode.

The value displayed is the maximum or minimum reading taken since the minimum and maximum recording mode was entered.

APPLICATIONS

MEASURING VOLTAGE (AC/DC)

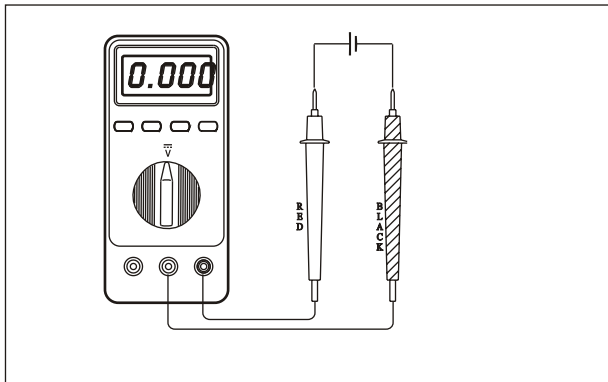

APPLICATIONS

This section discusses some common applications for your meter, and alerts you to some considerations to keep in mind when taking measurement.

Measuring Voltage (AC/DC)

To measure voltage, connect the black lead to common terminal and red one to V/Ω terminal, and turn the rotary switch to DCV or ACV range as Figure 5-1.

Connect the meter in parallel with the load or circuit under test.

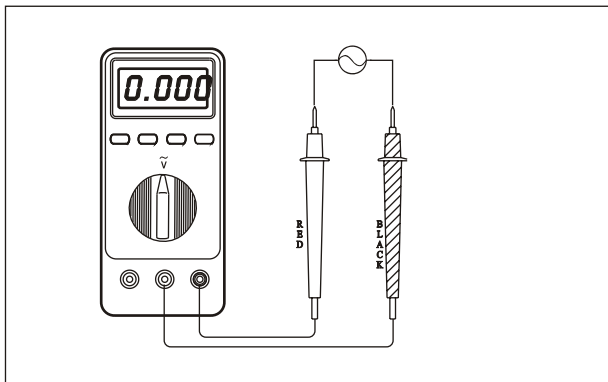

Each of AC/DC voltage ranges presents an input impedance of approximately $10M\Omega$ in parallel with less than 50 pF . AC voltage is AC-Coupled to the $10M\Omega$ input, and frequency range is 50Hz to 400Hz (50~100Hz for 400mV Range) and 50/60Hz for DM-333

Over range is being indicated by flickered figure "4" in display (DM-331, 332, 334) and by character "OL" (DM-333)

Figure 5-1. Measuring Voltage

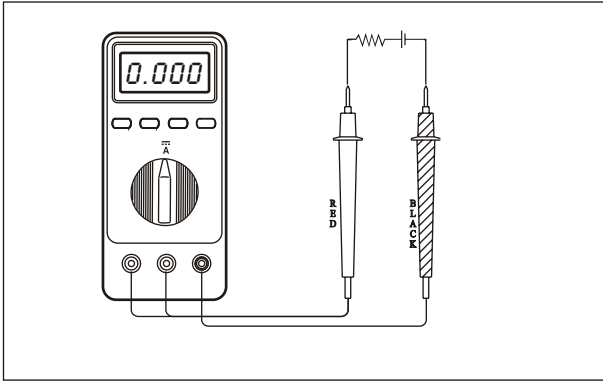

Measuring Current (AC/DC)

If you do not know approximately what the current is, connect the black lead to common terminal and red one to 10A input terminal first to see if you have a safe level for the mA input (max. 400mA) terminal and turn the rotary switch to DCA or ACA range as Figure 5-2.

Connect the meter in series with the load or circuit under test, and note that the frequency range for AC current measurement is 50Hz to 400Hz and 50/60Hz for DM-333

When measuring current, the meter's internal shunt resistors develop a voltage across the meter's terminals called burden voltage. This voltage drop is very low in your meter, but it may affect precision circuits or measurements.

Over range is being indicated by flickered figure 4 in display. (DM-331, 332, 334) and by character OL (DM-333)

WARNING

DO NOT APPLY THE VOLTAGE OF MORE THAN 60V DC OR 30V AC RMS.

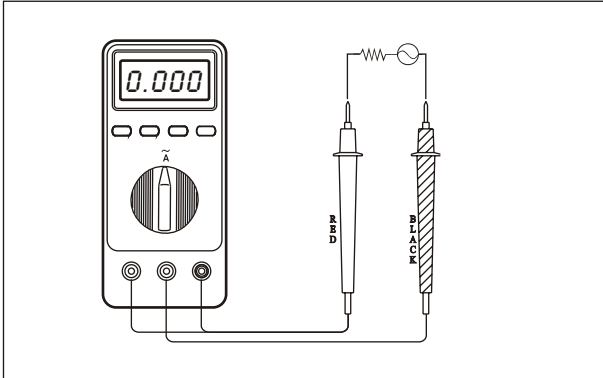
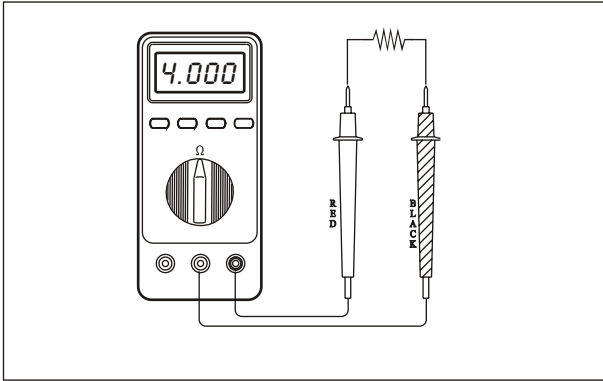

Figure 5-2. Measuring Current

APPLICATIONS

MEASURING RESISTANCE



Measuring Resistance

To measure resistance, connect the black lead to common terminal and red one to v/Ω terminal, and turn the rotary switch to Ω range as Figure 5-3. Connect the test leads across the resistance under measurement.

CAUTION

Turn off power on the test circuit and discharge all capacitors before attempting in-circuit resistance measurements, If an external voltage is present across a component, it will be impossible to take an accurate measurement of the resistance of that component.

Figure 5-3. Measuring Resistance

Due to the sensitive nature of 400 Ohm(DM-331, DM-332, DM-334), 320 Ohm(DM-333) range, a residual resistance is present. This resistance will display itself, if the probes are shorted. This residual resistance is due to the lead, track and switch resistance. To obtain measurement within the stated accuracy when using the 400 Ohm(DM-331, DM-332, DM-334), 320 Ohm(DM-333) range subtract from your value the residual resistance reading.

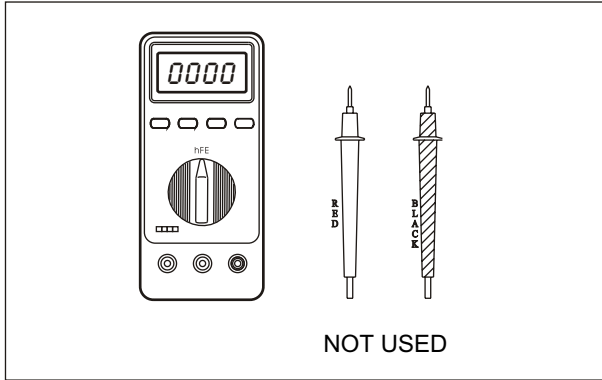

Transistor hFE Test (DM-312, 341)

Set rotary function switch to hFE range as Figure 5-4. insert the leads (Emitter, Base, Collector) into the proper holes of the socket on the front panel, according to transistor type NPN or PNP.

The display reads approximate eFE value at the test condition of Base current $2\mu\text{A}$ and VCE 3V.

Figure 5-4.hFE Test

APPLICATIONS

DIODE TEST

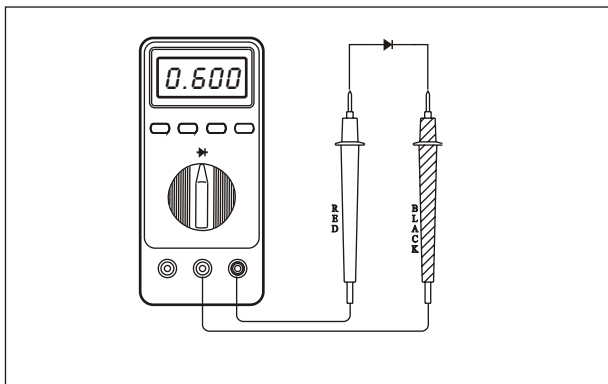

Figure 5-5. Diode Test

Diode Test

To perform a diode test, plug the black test lead to COM terminal and the red one into v/Ω inputs, turn the rotary switch to \blacktriangleright , and connect the test leads across the diode under measurement as Figure 5-5.

The forward voltage drop is displayed in V unit and overload (only, DM-333) or about 3.000V.

Test condition : Forward DC current (1mA)
Reversed DC voltage (3.0V)

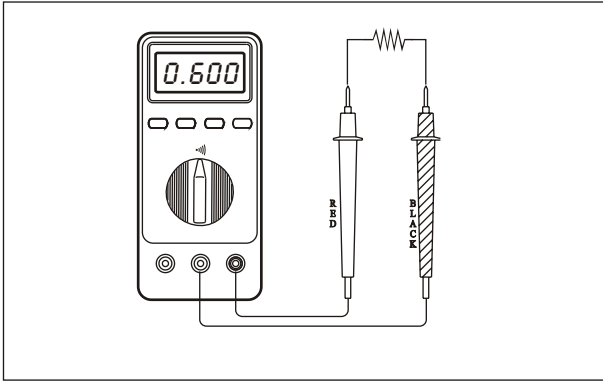



Figure 5-6. Continuity Test

Continuity Test

Continuity testing verifies that circuit connections are intact. To perform audible continuity tests, Turn the rotary switch to the  position.

Connect the black test lead to COM input terminal and the red one to V/Ω terminal, and the leads across the resistance or circuit under measurement as Figure 5-6.

Test resistance below $40\ \Omega$ (DM-331, 332, 334) or $20\ \Omega$ (DM-333) cause the meter to emit a continuous tone.

CAUTION

Turn off power on the test circuit and discharge all capacitors before attempting continuity testing.

APPLICATIONS

BATTERY TEST

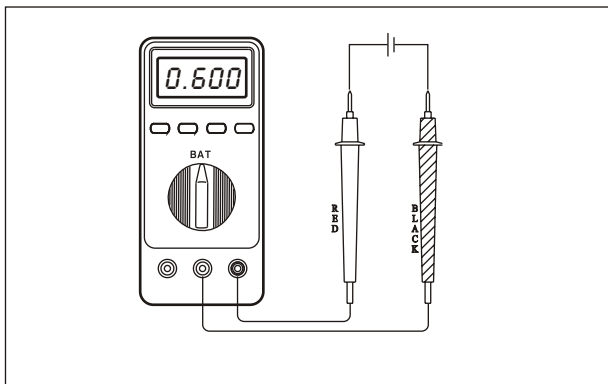

Figure 5-7. Battery Test

Battery Test (DM-331, 332)

To measure a battery, connect the black lead to common terminal and red one to v/Ω terminal and turn the rotary switch to BAT range as Figure 5-7. Connect the test leads across the battery under measurement.

The kinds of AAM/AM/CM/DC batteries can be measured on 1.5V BAT range, and FC-1006P, or LR-44 (button type) on 9V BAT range.

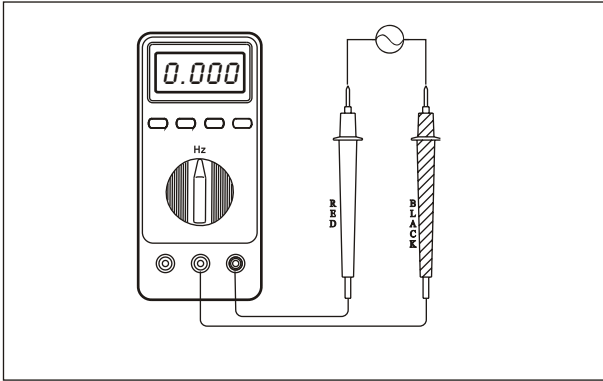

Figure 5-8. Measuring Frequency

Measuring Frequency (DM-332, 334)

In the frequency count mode, the frequency display auto-range to one of five range : 99.99Hz, 9.999kHz, 99.99kHz, 999.9kHz for frequencies above 10Hz, the update rate slows and follows the input signal. For frequencies below 1Hz, the display shows 0.000Hz for frequencies measurements.

Turn the rotary switch to the frequency range setting, connect the meter to the signal being measured, connecting the meter to the signal will normally allow the meter to auto-range to an appropriate range.

But the minimum input signal required to trigger the frequency counter varies, depending on the range and frequency.

If the input signal is below the trigger level, frequency measurements will not be taken.

If your readings are unstable, the input signal may be near the trigger level for that range.

APPLICATIONS

MEASURING FREQUENCY

• input sensitivity (RMS sinewave)

Freq.	10Hz ~ 40kHz ~ 300kHz ~ 1MHz
Sensitivity	100mV 2V 4V 8V

(NOTE)

Items	Contents	Conditions
Effective Number	· upper 3 digits -40.0Hz ~ 99.9kHz -400kHz ~ 999kHz	· 99.9kHz Range · 999kHz Range
Bar-graph	· disappear (Normal : disappear)	· Push twice Hold Key
Digits	· Varied and over displayed (9.999)	· Open the measurement Points

APPLICATIONS

MEASURING CAPACITANCE

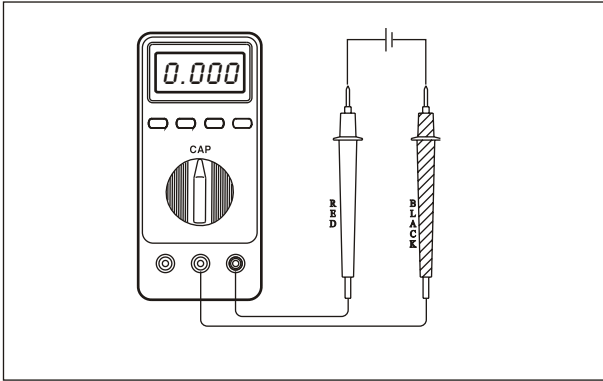

Figure 5-9. Measuring Capacitance

Measuring Capacitance (DM-332)

Turn off the power and discharge the capacitor before attempting a capacitance measurement. For measuring capacitor turn rotary switch to CAP and connect the test leads to the capacitor.

For capacitors less than 10nF or in noisy environments, use short test leads or a test fixture.

NOTE

- Capacitor should be discharged before being tested.
- When testing large capacitors, note that there will be a certain time lag before displaying final indication.
- The measurement value of capacitor subtract normal reading value from measurement reading value.

APPLICATIONS

INNER BATTERY VOLTAGE CHECK (DM-333)

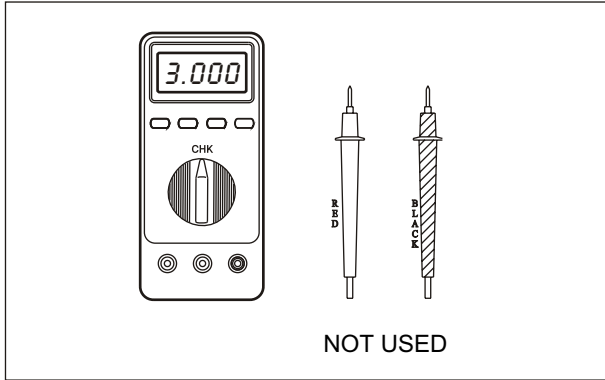

Inner Battery Voltage Check (DM-333)

To check inner battery voltage, set rotary function switch to CHK range like as Figure 5-10.

This display reads approximate inner battery voltage value.

Figure 5-4.Inner Battery Voltage Check

Calibration

Calibrate your meter once a year to ensure that it performs according to its specifications. Contact the nearest Distributor for calibration procedure.

Service

If the meter fails, check the battery and fuses and replace as needed. If the meter still does not work properly review this manual to make sure you are operation it correctly. If the meter still malfunctions, pack it securely in its original shipping container and forward it, postage paid, to the EZD's distributor.

Include a description of the malfunction. EZD assumes no responsibility for damage in transit.

A meter under warranty will be promptly repaired or replaced (at EZD'S option) and returned at no charge. If the warranty has laped, the meter will be repaired and returned for a fixed fee. Contact the nearest EZD's distributor for information and prices.

Battery Replacement (Figure 5-11)

- ① After disconnecting test leads and turning off the multimeter, Remove the one screw from the Battery cover.
- ② Disconnect battery from instrument and replace with a standard 1.5V battery.
- ③ Replace back cover and secure with one screws.

Fuse Replacement (Figure 5-11)

- ① After disconnecting test leads and turning off the multimeter, Remove back cover by removing three screws.
- ② The fuse located with PCB board, remove old fuse and replace with new fuse.
- ③ Replace back cover and secure with three screws.

CAUTION

For continued protection against fire, replace only with FUSE of the specified voltage and current ratings.

MAINTENANCE
CALIBRATION / REPLACEMENT

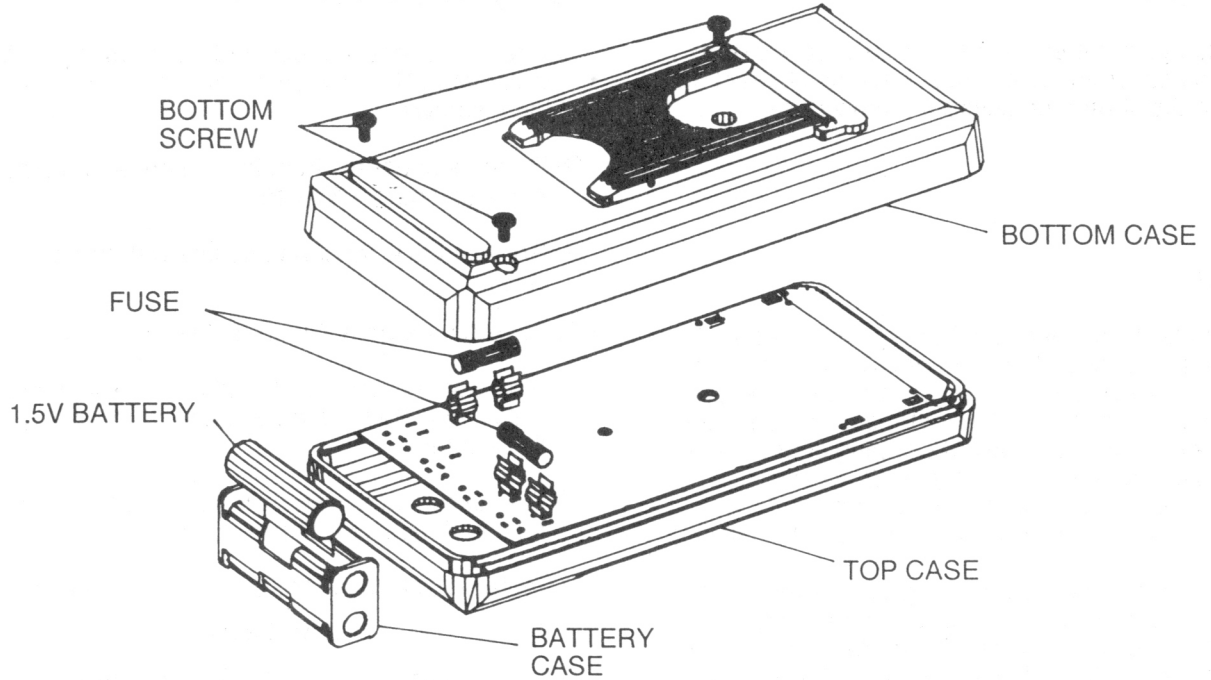

Figure 5-10. Battery & Fuse Replacement

Specifications

FUNCTION	DM-331			DM-332					
	RANGE	RESOLUTION	ACCURACY	RANGE	RESOLUTION	ACCURACY			
DC VOLTAGE	400 mV 4V	0.1 mV 1 mV	$\pm(0.5\%+1\text{dgt})$	400 mV 4V	0.1 mV 1 mV	$\pm(0.5\%+1\text{dgt})$			
	40V 400V	10 mV 100 mV		400 mV 4V	0.1 mV 1 mV		$\pm(0.5\%+1\text{dgt})$		
	1000V	1V	$\pm(0.7\%+2\text{dgt})$	1000V	1V	$\pm(0.7\%+2\text{dgt})$			
	AC VOLTAGE	400 mV 4V	0.1 mV 1 mV	$\pm(1.0\%+3\text{dgt})$	400 mV 4V	0.1 mV 1 mV	$\pm(1.0\%+3\text{dgt})$		
40V 400V		10 mV 10 mV	40V 400V		10 mV 10 mV				
750V		1V	750V		1V				
DC CURRENT		4 mA 40 mA	1 μ A 10 μ A		$\pm(1.5\%+2\text{dgt})$	4 mA 40 mA		1 μ A 10 μ A	$\pm(1.5\%+2\text{dgt})$
		400 mA 10A	0.1 mA 10 mA			400 mA 10A		0.1 mA 10 mA	

* Accuracy is given as $\pm(\%$ of reading + number of least significant digits) at 18°C to 28°C with relative humidity up to 80% for a period of one year after calibration.

* Sources like small hand-held radio transceivers, fixed station radio and television transmitters, vehicle radio transmitters and cellular phones generate electromagnetic radiation that may induce voltages in the test leads of the multimeter. In such cases the accuracy of the multimeter cannot be guaranteed due to physical reasons.

SPECIFICATIONS

DM-331, DM-332

Specifications

FUNCTION	DM-331			DM-332		
	RANGE	RESOLUTION	ACCURACY	RANGE	RESOLUTION	ACCURACY
AC CURRENT	4 mA	1 μ A	$\pm (1.5\% + 3 \text{ dgt})$	4 mA	1 μ A	$\pm (1.5\% + 3 \text{ dgt})$
	40 mA	10 μ A		40 mA	10 μ A	
	400 mA	0.1 mA		400 mA	0.1 mA	
	10 A	10 mA	$\pm (2.0\% + 6 \text{ dgt})$	10 A	10 mA	$\pm (2.0\% + 6 \text{ dgt})$
RESISTANCE	400 Ω	① 1 Ω	$\pm (0.7\% + 2 \text{ dgt})$	400 Ω	0.1 Ω	$\pm (0.7\% + 2 \text{ dgt})$
	4 k Ω	1 Ω		4 k Ω	1 Ω	
	40 k Ω	10 Ω		40 k Ω	10 Ω	
	400 k Ω	100 Ω		400 k Ω	100 Ω	
	4 M Ω	1 k Ω	$\pm (1.0\% + 2 \text{ dgt})$	4 M Ω	1 k Ω	$\pm (1.0\% + 2 \text{ dgt})$
40 M Ω	10 k Ω	$\pm (2.5\% + 2 \text{ dgt})$	40 M Ω	10 k Ω	$\pm (2.5\% + 2 \text{ dgt})$	
CAPACITANCE	-	-	-	40 nF	10 pF	$\pm (5.0\% + 4 \text{ dgt})$
	-	-	-	40 nF	100 pF	
	-	-	-	4 μ F	1 nF	
	-	-	-	40 μ F	10 nF	

* Accuracy is given as \pm (% of reading + number of least significant digits) at 18°C to 28°C with relative humidity up to 80% for a period of one year after calibration.

* Sources like small hand-held radio transceivers, fixed station radio and television transmitters, vehicle radio transmitters and cellular phones generate electromagnetic radiation that may induce voltages in the test leads of the multimeter. In such cases the accuracy of the multimeter cannot be guaranteed due to physical reasons.

Specifications

FUNCTION	DM-331			DM-332		
	RAANGE	RESOLUTION	ACCURACY	RAANGE	RESOLUTION	ACCURACY
FREQUENCY	-	-	-	100Hz 1 kHz 10 kHz 100 kHz 1 MHz	0.1Hz 1 Hz 10 Hz 100 Hz 1 kHz	$\pm (0.3\% + 3\text{dgt})$
DIODE TEST	TEST VOLTAGE : 3V MAXIMUM TEST CURRENT : 1 mA					
CONTINUITY TEST	RANGE : 400 Ω THRESHOLD : APPROX. 40 Ω OR LESS					
BATTERY TEST	1.5V BATTERY SINK CURRENT : 110 mA 9V BATTERY SINK CURRENT : 9 mA					
TRANSISTOR TEST	BASE CURRENT : 2 μ A VCE : APPROX. 3V					

* Accuracy is given as \pm (% of reading + number of least significant digits) at 18°C to 28°C with relative humidity up to 80% for a period of one year after calibration.

* Sources like small hand-held radio transceivers, fixed station radio and television transmitters, vehicle radio transmitters and cellular phones generate electromagnetic radiation that may induce voltages in the test leads of the multimeter. In such cases the accuracy of the multimeter cannot be guaranteed due to physical reasons.

SPECIFICATIONS

DM-333, DM-334

Specifications

FUNCTION	DM-333			DM-334		
	RAANGE	RESOLUTION	ACCURACY	RAANGE	RESOLUTION	ACCURACY
DC VOLTAGE	320 mA	0.1 mA	$\pm (0.5\% + 2 \text{dgt})$	400 mA	0.1 mA	$\pm (0.5\% + 1 \text{dgt})$
	3.2V	1 mA		4V	1 mA	
	32V	10 mV	$\pm (1.2\% + 4 \text{dgt})$	40V	10 mV	$\pm (0.5\% + 3 \text{dgt})$
	320V	100 mV		400V	100 mV	
1000V	1V	1000V		1V	$\pm (0.7\% + 2 \text{dgt})$	
AC VOLTAGE	3.2V	1 mV	$\pm (1.2\% + 4 \text{dgt})$	400 mV	0.1 mV	$\pm (1.0\% + 3 \text{dgt})$
	32V	10 mV		4V	1 mV	
	320V	100 mV		40V	10 mV	
	750V	1V		400V	100 mV	
DC CURRENT	320 μ A	0.1 μ A	$\pm (1.0\% + 2 \text{dgt})$	40 mA	10 μ A	$\pm (1.5\% + 2 \text{dgt})$
	3200 μ A	1 μ A	$\pm (2.0\% + 2 \text{dgt})$			
	32 mA	10 μ A	$\pm (1.0\% + 2 \text{dgt})$			
	320 mA	0.1 mA	$\pm (2.0\% + 2 \text{dgt})$			
	10A	10 mA	$\pm (2.5\% + 2 \text{dgt})$			

* Accuracy is given as \pm (% of reading + number of least significant digits) at 18°C to 28°C with relative humidity up to 80% for a period of one year after calibration.

* Sources like small hand-held radio transceivers, fixed station radio and television transmitters, vehicle radio transmitters and cellular phones generate electromagnetic radiation that may induce voltages in the test leads of the multimeter. In such cases the accuracy of the multimeter cannot be guaranteed due to physical reasons.

Specifications

FUNCTION	DM-333			DM-334		
	RAANGE	RESOLUTION	ACCURACY	RAANGE	RESOLUTION	ACCURACY
AC CURRENT	320 μ A	0.1 μ A	$\pm(2.0\%+5\text{dgt})$	40mA 400mA	10 μ A 0.1mA	$\pm(1.5\%+3\text{dgt})$
	3200 μ A	1 μ A				
	32mA	10 μ A				
	320mA	0.1mA				
	10A	10mA	$\pm(2.5\%+5\text{dgt})$	10A	10mA	$\pm(2.0\%+6\text{dgt})$
RESISTANCE	320 Ω	0.1 Ω	$\pm(1.0\%+2\text{dgt})$	400 Ω 4k Ω 40k Ω 400k Ω	0.1 Ω 1 Ω 10 Ω 100 Ω	$\pm(0.7\%+2\text{dgt})$
	3.2k Ω	1 Ω				
	32k Ω	10 Ω				
	320k Ω	100 Ω				
	3.2M Ω	1k Ω	$\pm(3.5\%+5\text{dgt})$	4M Ω	1k Ω	$\pm(1.0\%+2\text{dgt})$
	32M Ω	10k Ω		40M Ω	10k Ω	$\pm(2.5\%+2\text{dgt})$

* Accuracy is given as \pm (% of reading + number of least significant digits) at 18°C to 28°C with relative humidity up to 80% for a period of one year after calibration.

* Sources like small hand-held radio transceivers, fixed station radio and television transmitters, vehicle radio transmitters and cellular phones generate electromagnetic radiation that may induce voltages in the test leads of the multimeter. In such cases the accuracy of the multimeter cannot be guaranteed due to physical reasons.

SPECIFICATIONS

DM-333, DM-334

Specifications

FUNCTION	DM-333			DM-334		
	RAANGE	RESOLUTION	ACCURACY	RAANGE	RESOLUTION	ACCURACY
FREQUENCY	-	-	-	100Hz 1kHz 10kHz 100kHz 1MHz	0.1Hz 1Hz 10Hz 100Hz 1kHz	$\pm(2.5\%+2\text{dgt})$
DIODE TEST	TEST VOLTAGE : 3V MAXIMUM TEST CURRENT : 1 mA					
CONTINUITY TEST	RANGE : 320 Ω THRESHOLD : APPROX. 20 Ω or LESS			RANGE : 400 Ω THRESHOLD : APPROX. 40 Ω or LESS		

* Accuracy is given as \pm (% of reading + number of least significant digits) at 18°C to 28°C with relative humidity up to 80% for a period of one year after calibration.

* Sources like small hand-held radio transceivers, fixed station radio and television transmitters, vehicle radio transmitters and cellular phones generate electromagnetic radiation that may induce voltages in the test leads of the multimeter. In such cases the accuracy of the multimeter cannot be guaranteed due to physical reasons.

