

# User Manual



[Visit us at www.TestEquipmentDepot.com](http://www.TestEquipmentDepot.com)  
[Back to the Extech RH520A info Page](#)

## Humidity-Temperature Chart Recorder

### Model RH520

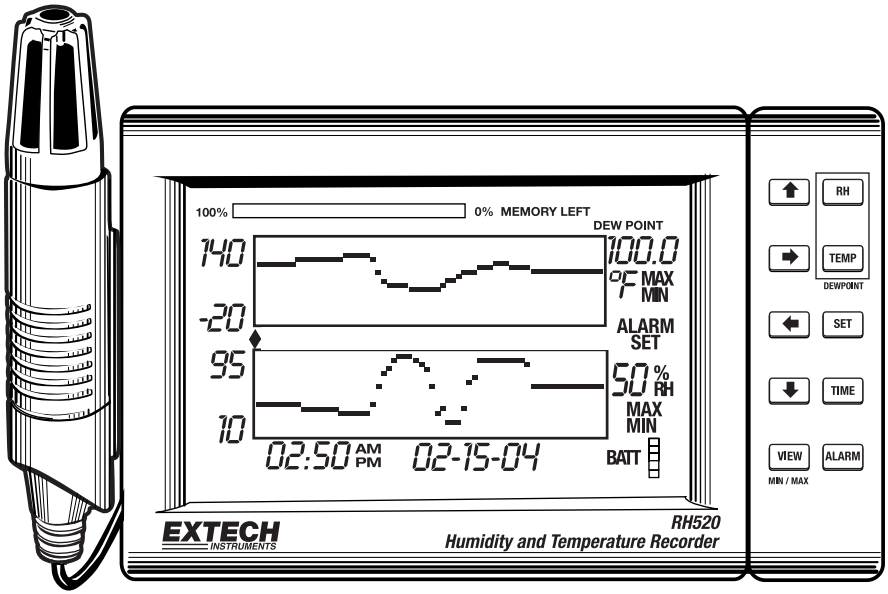

## Introduction

---

Congratulations on your purchase of the Extech RH520 Temperature + Humidity Chart Recorder. The RH520 measures and displays Temperature, Humidity, and Dew Point.

The remote (detachable) probe senses the ambient conditions while the LCD display graphs and provides numerical representation of the readings. Programmable audio-visual alarms alert the user when ambient conditions reach alarm presets. The optional alarm module permits automatic relay switching when alarm presets are reached.

The RH520 Internal Memory can store up to 49,152 measurements for later transfer to a PC. Careful use of this instrument will provide years of reliable service.

## Warranty

---

**EXTECH INSTRUMENTS CORPORATION** warrants this instrument to be free of defects in parts and workmanship for **one year** from date of shipment (a six month limited warranty applies to sensors and cables). If it should become necessary to return the instrument for service during or beyond the warranty period, contact the Customer Service Department at (781) 890-7440 ext. 210 for authorization or visit our website [www.extech.com](http://www.extech.com) for contact information. A Return Authorization (RA) number must be issued before any product is returned to Extech. The sender is responsible for shipping charges, freight, insurance and proper packaging to prevent damage in transit. This warranty does not apply to defects resulting from action of the user such as misuse, improper wiring, operation outside of specification, improper maintenance or repair, or unauthorized modification. Extech specifically disclaims any implied warranties or merchantability or fitness for a specific purpose and will not be liable for any direct, indirect, incidental or consequential damages. Extech's total liability is limited to repair or replacement of the product. The warranty set forth above is inclusive and no other warranty, whether written or oral, is expressed or implied.

## Specifications

---

Display	Large, backlit graphical LCD
Temperature measurement range	-20.0 to 140.0°F (-28 to 60°C)
Humidity measurement range	10 to 95%
Dew point temperature	-20.0 to 140.0°F (-28 to 60°C)
Accuracy	±3.0% RH and 1.8°F (1°C) for temperature
Internal memory storage	49,152 complete reading sets
Sampling interval	Selectable recording rate: 0.1 to 199.9 minutes
Graph scaling	User selectable in 10°F, 5°C and 10% increments
Low battery indication	5-segment battery indicator
Power supply	Three (3) 'AA' batteries and AC adaptor (included)
Battery life	4 weeks typical, using alkaline batteries
Operating Temperature	CONTROL MODULE and DISPLAY: 32 to 120°F (0 to 50°C) SENSOR: -20 to 140°F (-28 to 60°C)
Operating Humidity	CONTROL MODULE and DISPLAY: 90% RH max. SENSOR: 95% RH max.
Dimensions	5.0 x 7.7 x 0.9" (127 x 196 x 23mm)
Weight	12.6oz (357g)

# RH520 Description

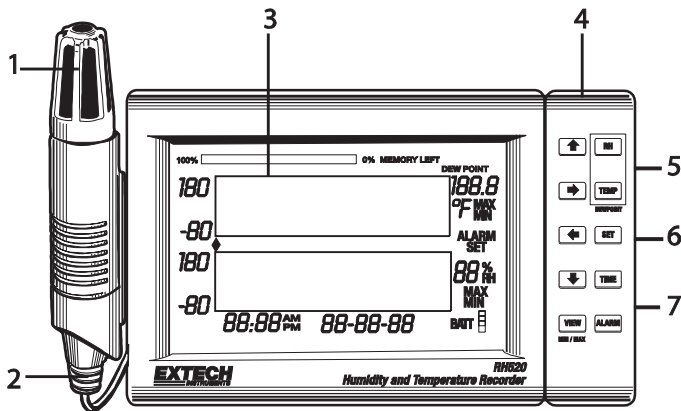

- 1. Remote sensor
- 2. Sensor cable
- 3. LCD Display
- 4. Swivel keypad / table-top stand
- 5. PC interface jack
- 6. Universal alarm module jack
- 7. AC adaptor jack

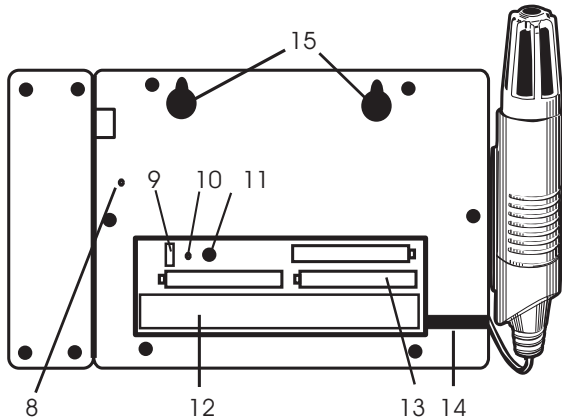

- 8. DATA RESET button (clears recorded measurement data and alarm history)
- 9. Temperature units select switch (C or F)
- 10. PROGRAMMING RESET button (clears programming changes but retains measurement data and alarm history)
- 11. Display CONTRAST adjust
- 12. Sensor cable storage area
- 13. 'AA' 1.5V batteries
- 14. Sensor cable run
- 15. Wall mount holes

## DISPLAY DESCRIPTION

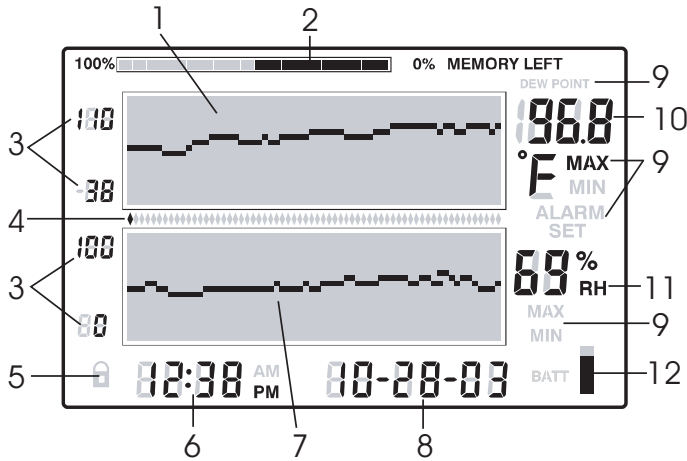

1. Temperature measurement graph
2. Internal memory usage meter
3. Vertical axis scale limits
4. Cursor / Alarm indicators
5. Push-button lock-out status indicator
6. Time display
7. Relative Humidity (RH) measurement graph
8. Date display
9. Function indicators
10. Numerical temperature reading display
11. Numerical RH reading display
12. Battery status indicator

## PUSH-BUTTON DESCRIPTION

### VIEW

Return the LCD to the Standard View  
 Escape from any setting function without storing value changes  
 Scrolls highest and lowest (MAX/MIN) readings when in Standard View

### ALARM

Display or Set alarm values

### TIME

Display a reading stored at specific Time and Date  
 Set and Display the recording Sampling Rate  
 Set the Time and Date

### SET

Used in combination with other buttons to set new parameter values  
 Stores new parameter values and returns to the Standard View

### TEMP

Used in combination with other buttons to set the vertical graph range  
 Used in combination with other buttons to set temperature alarm values  
 Used in combination with the RH button to display Dew Point

### RH

Used in combination with other buttons to set the vertical graph range  
 Used in combination with other buttons to set RH alarm values  
 Used in combination with the TEMP button to display Dew Point

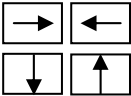

Right, left, down, and up arrow buttons for scrolling data and navigating the display

## KEYPAD QUICK REFERENCE (ALSO SHOWN ON REAR OF THE RH520 HOUSING)

Key-press	Function	Second / Alternate Keystrokes
VIEW	Selects view mode	VIEW modes: Normal, TEMPmax, RHmax, TEMPmin, RHmin
SET	Saves new settings	VIEW to cancel, exit mode
ARROW KEYS	Scroll through selections	Movers cursor through stored points
TIME	View reading at specific time/date	Arrow keys to select, VIEW to exit
TEMP + RH	View Dew Point temp.	VIEW to exit
ALARM	Step back through ALARM points	ALARM selects next Alarm, VIEW to exit
SET + TEMP + ALARM	Enters Set TEMP Alarm mode	ALARM selects HIGH/LOW, SET to save
SET + RH + ALARM	Enters Set RH Alarm mode	ALARM selects HIGH/LOW, SET to save
TIME + VIEW	View Sample Rate	VIEW to exit
SET + TIME + VIEW	Enter Set Sample Rate mode	SET to save, VIEW to exit
SET + TIME	Enter Set Time/Date mode	SET to save, VIEW to exit
SET + TEMP + UP	Enter Set TEMP Vertical Scale mode	TEMP selects upper/lower, SET to save
SET + RH + UP	Enter Set RH Vertical Scale mode	RH selects upper/lower, SET to save

# Getting Started

---

## POWER

1. The RH520 runs on battery power or AC adaptor (4.5VDC 300mA). Battery power consists of three (3) 'AA' batteries. See the Battery Replacement section of this manual when changing/installing the batteries. Note: Batteries and adaptor are supplied.
2. Plug the AC adaptor in the AC adaptor jack shown in the Description section. The batteries will act as battery back-up in the event of an AC power failure.
3. Once the batteries are installed or the adaptor properly connected, the RH520 will begin displaying.
4. In the unlikely event that the AC power AND the battery back-up fails, the RH520 will require a "Programming Reset" to reset the display. Press the **RESET** button located inside the battery compartment. "Reset" clears all settings. Time, Date and the logging interval need to be entered. The measurement data and alarm history, however, will still be retained in the non-volatile memory.
5. The 5-segment battery life indicator allows the user to track the status of the battery. When all 5-segments are dark, the battery is fully charged. Segments switch off as the battery ages. When the battery indicator has only one segment left the batteries must be replaced immediately.

**NOTE: Always set the date and time immediately after batteries have been installed or after the RESET button has been pressed.**

## MOUNTING THE RH520

The RH520 can be used in the following ways:

1. Placed on a table top where the swivel keypad is employed as the table stand
2. Wall mounted using the rear mounting holes

## MEASUREMENT PROBE

The probe is attached to the meter with a 1 meter cable and can be used in two ways:  
Stored in the RH520 probe cradle or simply held in hand

## PUSH-BUTTON LOCK-OUT SECURITY FEATURE

The RH520 can be secured from tampering by having its push-buttons locked.

1. Press for approx. 1 second and release the **UP, DOWN, LEFT, and SET** arrow buttons simultaneously to lock-out the push-buttons.

**Note:** The security lock out can only be performed from the main view screen. If a scroll key or the time button was pressed prior to setting up the lock-out, the user must scroll back to the main screen.

2. Press for approx. 1 second and release the **UP, DOWN, LEFT, and SET** arrow buttons simultaneously to restore the operation of the push-buttons

## SETTING THE TIME AND DATE

1. From the Standard View, press the **SET** and **TIME** buttons simultaneously
2. The SET indicator will appear
3. Use the **UP** and **DOWN** arrow buttons to set the time
4. Use the **LEFT** and **RIGHT** arrow buttons to step through the minutes, hours, AM/PM/24-Hour, day, month, and year parameters
  - If AM or PM is selected, the date format will be MONTH-DAY-YEAR
  - If 24-hour is selected, the date format will be DAY-MONTH-YEAR
5. Press **SET** at any time to store the new value and revert to the Standard View
6. Press **VIEW** at any time to return to the Standard View without storing any changes

## CLEARING THE INTERNAL MEMORY

Press the **RESET** button (located inside the battery compartment) to clear the display and measurement parameters (sample rate, vertical resolution), and to reset the display.

Press the **DATA RESET** button (located on the back of the unit) to clear all of the stored readings, the MAX/MIN values, and the Alarm history.

## SELECTING THE UNIT OF MEASURE FOR TEMPERATURE (°C/°F)

The °C/°F switch, located inside the battery compartment, is used to select the unit of measure for temperature displays

## SETTING THE VERTICAL RESOLUTION FOR THE TEMPERATURE GRAPHIC DISPLAY

1. Press the **SET**, **TEMP**, and **UP** arrow buttons simultaneously
2. The upper temperature range indicator will flash and the SET icon will appear
3. Use the **UP-DOWN** buttons to change the upper temperature value (10° increments for °F, 5° increments for °C).
4. Press the **TEMP** button and the lower temperature range indicator will flash
5. Use the **UP-DOWN** buttons to change the lower temperature value (10° increments for °F, 5° increments for °C). Note that the upper and lower temperature values cannot overlap and the upper value cannot be less than zero
6. Press the **TEMP** button to toggle upper and lower range values
7. Press the **SET** button at any time to store a value and return the instrument to the Standard View
8. Press **VIEW** at any time to return to the Standard View

## SETTING THE VERTICAL RESOLUTION FOR THE RH GRAPHIC DISPLAY

1. Press the **SET**, **RH**, and **UP** arrow buttons simultaneously
2. The upper RH range indicator will flash and the SET icon will appear
3. Use the **UP-DOWN** buttons to change the upper RH value in 10% increments
4. Press the **RH** button and the lower RH range indicator will flash
5. Use the **UP-DOWN** buttons to change the lower RH value in 10% increments
6. Note that the upper and lower RH values cannot overlap
7. Press the **RH** button to toggle upper and lower range values
8. Press the **SET** button at any time to store a value and return the instrument to the Standard View
9. Press **VIEW** at any time to return to the Standard View

## SETTING THE RECORDING SAMPLE RATE

The Sampling Rate is the rate at which the RH520 automatically records measurements

1. Press the **SET**, **VIEW**, and **TIME** arrow buttons simultaneously from the Standard View
2. The current Sample Rate (in minutes) will appear in the numerical temperature display area
3. The whole minutes area of the numeric display will flash
4. The MIN and the SET icons will switch on. All other TEMP and RH indicators and numeric displays will switch off
5. The projected TIME and DAYS representing the moment the internal memory will be full (based on the sample rate) is displayed in the TIME and DATE display areas.
6. Use the **UP-DOWN** arrow buttons to increment/decrement the rate. Use the **LEFT-RIGHT** arrow buttons to step through the units of time
7. Sample rates can be set from 0.1 minutes up to 199.9 minutes
8. Press the **SET** button at any time to save changes and return to the Standard View
9. Press **VIEW** at any time to return to the Standard View without saving the changes

## SETTING THE TEMPERATURE ALARM LIMITS

1. Press the **SET**, **TEMP**, and **ALARM** buttons simultaneously from the Standard View
2. The ALARM, SET, and MAX indicators will switch on. All of the RH indicators will switch off
3. Use the **UP-DOWN** arrow buttons to increment/decrement the HIGH temperature alarm limit. Use the **LEFT-RIGHT** arrow buttons to step through the decades
4. Press the **ALARM** button. The MIN (low alarm) indicator will switch on
5. Use the **UP-DOWN** arrow buttons to increment/decrement the LOW temperature alarm limit. Use the **LEFT-RIGHT** arrow buttons to step through the decades
6. The HIGH and LOW alarm limits cannot overlap
7. Use the **ALARM** button to toggle between the HIGH and the LOW alarm limits
8. Press the **SET** button at any time to save changes and return to the Standard View
9. Press **VIEW** at any time to return to the Standard View without saving the changes

## SETTING THE RH ALARM LIMITS

1. Press the **SET**, **RH**, and **ALARM** buttons simultaneously from the Standard View
2. The ALARM, SET, and MAX indicators will switch on. All of the TEMP indicators will switch off
3. Use the **UP-DOWN** arrow buttons to increment/decrement the HIGH RH alarm limit. Use the **LEFT-RIGHT** arrow buttons to step through the decades
4. Press the **ALARM** button. The MIN (low alarm) indicator will switch on
5. Use the **UP-DOWN** arrow buttons to increment/decrement the LOW RH alarm limit. Use the **LEFT-RIGHT** arrow buttons to step through the decades
6. The HIGH and LOW alarm limits cannot overlap
7. Use the **ALARM** button to toggle between the HIGH and the LOW alarm limits
8. Press the **SET** button at any time to save changes and return to the Standard View
9. Press **VIEW** at any time to return to the Standard View without saving the changes

## STANDARD VIEW

The Standard View is the display state of the RH520 when it is turned on. Refer to the diagram in the display description section of this manual for a representation of the Standard View. To reach the Standard View at any time, press the **VIEW** button. Note that the display automatically reverts to the Standard View five (5) minutes after the last button press.

## CURSOR

The CURSOR location is indicated by a small diamond located between the two graphs. See diagram. There is one diamond for each horizontal pixel in the graph (64 positions). The date, time, and measurements for the data point selected by the cursor are shown in the Time/Date and numerical measurement display fields.

- Each press of the **RIGHT ARROW** button will move the cursor to the right. When the cursor reaches the right side limit, the graph will move to the left. Holding the button down will speed the scrolling rate. When the cursor reaches the oldest (last) reading, it will stop.
- Each press of the **LEFT ARROW** button will move the cursor to the left. When the cursor reaches the left side limit, the graph will move to the right. Holding the button down will speed the scrolling rate. When the cursor reaches the newest (latest) reading, it will stop.
- Each press of the **UP ARROW** button will shift the graph to the next set of 64 values; to the left of the ones currently displayed (the cursor will not move).
- Each press of the **DOWN ARROW** button will shift the graph to the next set of 64 values; to the right of the one displayed (the cursor will not move).

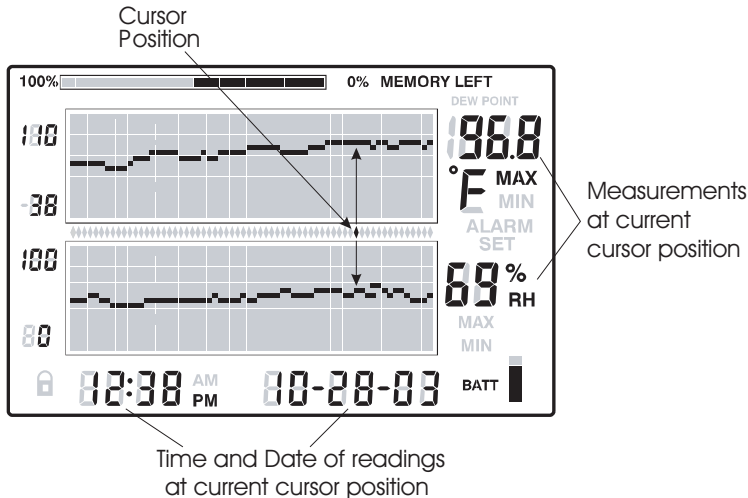

## MAX-MIN DISPLAYS

1. Press the **VIEW** button in the Standard View to display the highest (MAX) and lowest (MIN) temperature and RH readings from all of the stored measurement records.
2. When viewing the highest readings, the MAX indicator will switch on. When viewing the lowest readings, the MIN icon will switch on.
3. The cursor will move to the location of the MIN or MAX reading within the graph. If not within the graph currently displayed, the cursor will move to the right-most position and the graph will shift accordingly so that the relevant data point can be viewed.
4. Use the **VIEW** button to step through the highest and lowest temperature readings and then the highest and lowest RH readings. When the MAX or MIN indicator is ON under the temperature reading digits, the display is showing the MAX or MIN temperature. When the MAX or MIN indicator is ON under the RH reading digits, the display is showing the MAX or MIN relative humidity.

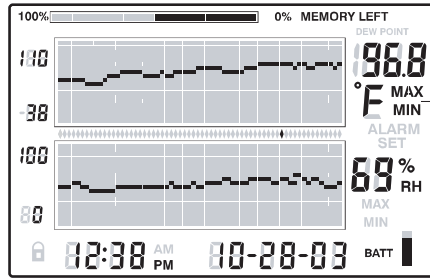

MAX or MIN indicator is ON when in the MAX or MIN mode

## ALARM DISPLAYS

1. Press the **ALARM** button from the Standard View to analyze the most recent alarm activity (temperature or humidity), if any. The ALARM display icon and the relevant upper (temperature) or lower (RH) graph pixel will flash.
2. The cursor will move to the location within the graph. If not within the graph currently displayed, the cursor will move to the right-most position and the graph will shift accordingly so that the relevant data point can be viewed.
3. Press the **ALARM** button again to view the second most recent set of Alarms (if no alarms, the Standard View will appear)
4. Press the **ALARM** button again to view the third most recent set of Alarms (if no alarms, the Standard View will appear)
5. This procedure can continue until no further alarms exist and pressing the **ALARM** button will only bring up the Standard View
6. In the example diagram, the RH520 is showing a high temperature alarm (MAX and ALARM indicators on).

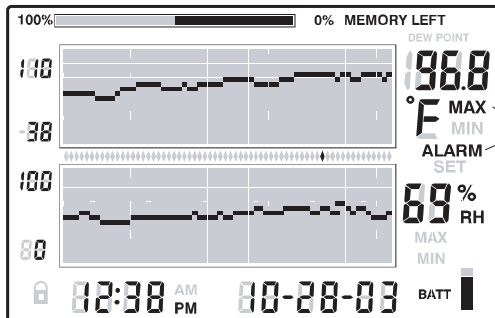

MAX Temperature Alarm Mode

### USING THE CLOCK TO SORT THROUGH STORED READINGS

1. Press the **TIME** button in the Standard View mode
2. Use the **ARROW** buttons to select a particular time of day.
3. The temperature and humidity readings for the selected Time will display.
4. Press **VIEW** to return to the Standard View.

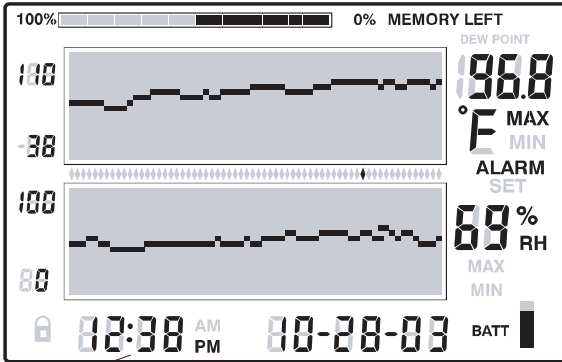

Use the arrow buttons to scroll to the desired time. Readings recorded at the selected time will display

### DEW POINT DISPLAY

Press the **TEMP** and the **RH** buttons simultaneously to view the Dew Point reading. The DEW POINT display icon will switch on above the temperature. See the diagram below. Press **VIEW** to return to the standard view mode.

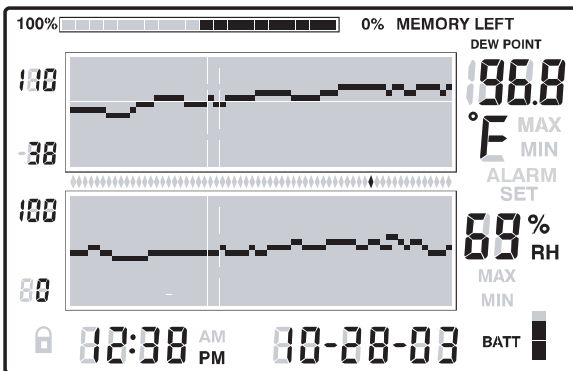

### SAMPLE RATE DISPLAY

1. Press the **VIEW** and the **TIME** buttons simultaneously from the Standard View mode
2. Both numerical displays will switch off so that the LCD can show only the sample rate in minutes (the MIN display icon will switch on)
3. The projected TIME-DAYS that the internal memory will be full (based on the current sample rate) is displayed in the TIME and DATE display areas
4. To change the sample rate, refer to the programming section of this manual.
5. Press the **VIEW** button to return to the Standard View

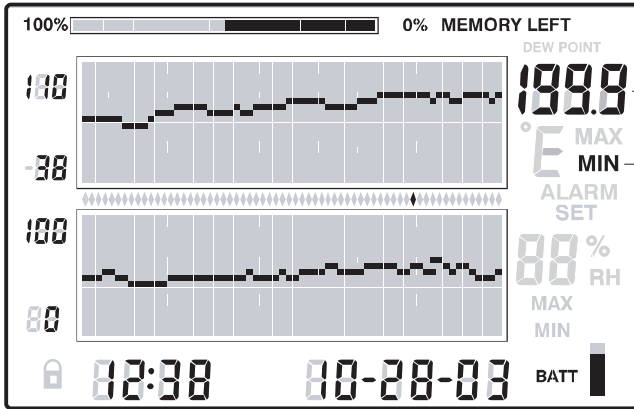

12 Hrs 38 minutes 10 months 28 days 3 years

Sample rate in minutes  
MINUTES indicator

Displays how long it will take to finish recording in hours:minutes months/days/years. Not the actual date.

### *Software and Data Download*

---

Software operational instructions are located on the ExTerm software disc.

## *Alarm Conditions and the Alarm History*

---

When in Standard View mode:

- If the ALARM display icon is flashing – an Alarm condition currently exists.
- If the ALARM display icon is ON steady – there are past Alarms to view in the Alarm history. Use the ALARM button to view the Alarm history as described elsewhere in this manual.
- If an Alarm is tripped, press the ALARM button to silence it.
- Press and hold the SET button for 2 seconds to clear an alarm through the external relay module.

When in Alarm View or Time View mode:

- If the ALARM display icon is flashing – the cursor is currently on an Alarm condition.
- If the ALARM display icon is ON steady – there are past Alarms to view in the Alarm history. Use the cursors or the ALARM button to view the Alarm history as described elsewhere in this manual.

Note that the Alarm display icon and the external alarm relay module can be controlled separately as indicated in the statements above.

## *Factory Default Settings*

---

- Default LCD mode: Standard View
- Temperature Graph Vertical Resolution: 0 to 100°F
- RH Graph Vertical Resolution: 0 to 100%
- TEMP and RH Alarm Limits: 0 (low) and 100 (high)
- Sample Rate: One (1) reading stored per minute

## *Battery Replacement*

---

The 5-segment battery life indicator allows the user to track the status of the battery. When all 5-segments are dark, the battery is fully charged. Segments switch off as the battery ages. When the battery indicator has only one segment left the batteries must be replaced immediately.

1. Open the battery compartment on the rear of the instrument
2. Remove the old batteries and replace with three (3) heavy duty alkaline 'AA' batteries observing polarity
3. Replace the battery compartment cover securely
4. The RH520 will require a "Programming Reset" to reset the display. Press the **RESET** button located inside the battery compartment. "Reset" clears all settings. Time, Date and the logging interval need to be entered. The measurement data and alarm history, however, will still be retained in the non-volatile memory.

## *Optional Alarm Relay Module*

---

The alarm output jack, located on the swivel push-button stand, drives the optional Remote Alarm Relay Module (cable and relay). The relay module can be used to power external warning or switching devices when programmed alarm limits are reached. Refer to the manual supplied with the optional module for connection information.

## *Calibration and Repair Services*

---

**Extech offers repair and calibration services** for the products we sell. Extech also provides NIST certification for most products. Call the Customer Service Department for information on calibration services available for this product. Extech recommends that annual calibrations be performed to verify meter performance and accuracy.



**Support line (781) 890-7440**

Technical support: Extension 200; E-mail: [support@extech.com](mailto:support@extech.com)

Repair & Returns: Extension 210; E-mail: [repair@extech.com](mailto:repair@extech.com)

**Product specifications subject to change without notice**

**Copyright © 2007 Extech Instruments Corporation**

All rights reserved including the right of reproduction in whole or in part in any form