

User's Guide

EXTECH[®]

INSTRUMENTS
A FLIR COMPANY

Wireless TRMS Multimeter

Model EX540

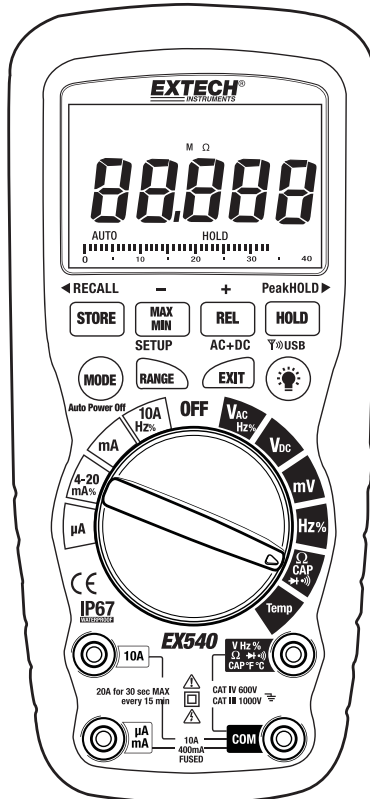

Introduction

This meter measures AC/DC Voltage, AC/DC Current, Resistance, Capacitance, Frequency (electrical & electronic), Duty Cycle, Diode Test, and Continuity plus Thermocouple Temperature. It can store and recall data. It features a waterproof, rugged design for heavy duty use. This meter can transmit data wirelessly when linked to a PC. Proper use and care of this meter will provide many years of reliable service.

Safety



This symbol adjacent to another symbol, terminal or operating device indicates that the operator must refer to an explanation in the Operating Instructions to avoid personal injury or damage to the meter.

WARNING

This **WARNING** symbol indicates a potentially hazardous situation, which if not avoided, could result in death or serious injury.

CAUTION

This **CAUTION** symbol indicates a potentially hazardous situation, which if not avoided, may result damage to the product.

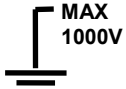

This symbol advises the user that the terminal(s) so marked must not be connected to a circuit point at which the voltage with respect to earth ground exceeds (in this case) 1000 VAC or VDC.



This symbol adjacent to one or more terminals identifies them as being associated with ranges that may, in normal use, be subjected to particularly hazardous voltages. For maximum safety, the meter and its test leads should not be handled when these terminals are energized.



This symbol indicates that a device is protected throughout by double insulation or reinforced insulation.

PER IEC1010 OVERVOLTAGE INSTALLATION CATEGORY

OVERVOLTAGE CATEGORY I

Equipment of OVERVOLTAGE CATEGORY I is equipment for connection to circuits in which measures are taken to limit the transient overvoltages to an appropriate low level.

Note – Examples include protected electronic circuits.

OVERVOLTAGE CATEGORY II

Equipment of OVERVOLTAGE CATEGORY II is energy-consuming equipment to be supplied from the fixed installation.

Note – Examples include household, office, and laboratory appliances.

OVERVOLTAGE CATEGORY III

Equipment of OVERVOLTAGE CATEGORY III is equipment in fixed installations.

Note – Examples include switches in the fixed installation and some equipment for industrial use with permanent connection to the fixed installation.

OVERVOLTAGE CATEGORY IV

Equipment of OVERVOLTAGE CATEGORY IV is for use at the origin of the installation.

Note – Examples include electricity meters and primary over-current protection equipment

SAFETY INSTRUCTIONS

This meter has been designed for safe use, but must be operated with caution. The rules listed below must be carefully followed for safe operation.

1. **NEVER** apply voltage or current to the meter that exceeds the specified maximum:

Input Protection Limits	
Function	Maximum Input
V DC or V AC	1000VDC/AC rms
mA AC/DC	500mA 1000V fast acting fuse
A AC/DC	10A 1000V fast acting fuse (20A for 30 seconds max every 15 minutes)
Frequency, Resistance, Capacitance, Duty Cycle, Diode Test, Continuity	1000VDC/AC rms
Temperature	1000VDC/AC rms
Surge Protection: 8kV peak per IEC 61010	

2. **USE EXTREME CAUTION** when working with high voltages.
3. **DO NOT** measure voltage if the voltage on the "COM" input jack exceeds 1000V above earth ground.
4. **NEVER** connect the meter leads across a voltage source while the function switch is in the current, resistance, or diode mode. Doing so can damage the meter.
5. **ALWAYS** discharge filter capacitors in power supplies and disconnect the power when making resistance or diode tests.
6. **ALWAYS** turn off the power and disconnect the test leads before opening the covers to replace the fuse or batteries.
7. **NEVER** operate the meter unless the back cover and the battery and fuse covers are in place and fastened securely.
8. If the equipment is used in a manner not specified by the manufacturer, the protection provided by the equipment may be impaired.

Operating Instructions

WARNING: Risk of electrocution. High-voltage circuits, both AC and DC, are very dangerous and should be measured with great care.

1. ALWAYS turn the function switch to the **OFF** position when the meter is not in use.
2. If "OL" appears in the display during a measurement, the value exceeds the range you have selected. Change to a higher range.

DC VOLTAGE MEASUREMENTS

CAUTION: Do not measure DC voltages if a motor on the circuit is being switched ON or OFF. Large voltage surges may occur that can damage the meter.

1. Set the function switch to the **VDC** position.
2. Insert the black test lead banana plug into the negative **COM** jack. Insert the red test lead banana plug into the positive **V** jack.
3. Touch the black test probe tip to the negative side of the circuit. Touch the red test probe tip to the positive side of the circuit.
4. Read the voltage in the display.



AC VOLTAGE (FREQUENCY, DUTY CYCLE) MEASUREMENTS

WARNING: Risk of Electrocution. The probe tips may not be long enough to contact the live parts inside some 240V outlets for appliances because the contacts are recessed deep in the outlets. As a result, the reading may show 0 volts when the outlet actually has voltage on it. Make sure the probe tips are touching the metal contacts inside the outlet before assuming that no voltage is present.

CAUTION: Do not measure AC voltages if a motor on the circuit is being switched ON or OFF. Large voltage surges may occur that can damage the meter.

1. Set the function switch to the **VAC/Hz/%** position.
2. Insert the black test lead banana plug into the negative **COM** jack. Insert red test lead banana plug into the positive **V** jack.
3. Touch the black test probe tip to the neutral side of the circuit. Touch the red test probe tip to the "hot" side of the circuit.
4. Read the voltage in the main display and the frequency in the right auxiliary display
5. Press the **MODE** button to indicate "Hz".
6. Read the frequency in the main display.
7. Press the **MODE** button again to indicate "%".
8. Read the % of duty cycle in the main display.
9. With ACV in the main display, press EXIT for 2 seconds to measure AC+DC.



mV VOLTAGE MEASUREMENTS

CAUTION: Do not measure mV voltages if a motor on the circuit is being switched ON or OFF. Large voltage surges may occur that can damage the meter.

1. Set the function switch to the mV position.
2. Press the **MODE** button to indicate "**DC**" or "**AC**", or in AC range press **EXIT** for two seconds and chose "AC+DC"
3. Insert the black test lead banana plug into the negative **COM** jack. Insert the red test lead banana plug into the positive **V** jack.
4. Touch the black test probe tip to the negative side of the circuit. Touch the red test probe tip to the positive side of the circuit.
5. Read the mV voltage in the main display.
6. With AC mV in the main display, press EXIT for 2 seconds to measure AC+DC.

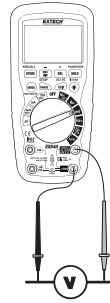

DC CURRENT MEASUREMENTS

CAUTION: Do not make 20A current measurements for longer than 30 seconds. Exceeding 30 seconds may cause damage to the meter and/or the test leads.

1. Insert the black test lead banana plug into the negative **COM** jack.
2. For current measurements up to 4000 μ A DC, set the function switch to the μ A position and insert the red test lead banana plug into the μ A/mA jack.
3. For current measurements up to 400mA DC, set the function switch to the mA position and insert the red test lead banana plug into the μ A/mA jack.
4. For current measurements up to 20A DC, set the function switch to the **10A/HZ/%** position and insert the red test lead banana plug into the **10A** jack.
5. Press the **MODE** button to indicate "**DC**" on the display.
6. Remove power from the circuit under test, then open up the circuit at the point where you wish to measure current.
7. Touch the black test probe tip to the negative side of the circuit. Touch the red test probe tip to the positive side of the circuit.
8. Apply power to the circuit.
9. Read the current in the display.



AC CURRENT (FREQUENCY, DUTY CYCLE) MEASUREMENTS

CAUTION: Do not make 20A current measurements for longer than 30 seconds. Exceeding 30 seconds may cause damage to the meter and/or the test leads.

1. Insert the black test lead banana plug into the negative **COM** jack.
2. For current measurements up to 4000 μ A AC, set the function switch to the **μ A** position and insert the red test lead banana plug into the **μ A/mA** jack.
3. For current measurements up to 400mA AC, set the function switch to the **mA** position and insert the red test lead banana plug into the **μ A/mA** jack.
4. For current measurements up to 20A AC, set the function switch to the **10A/HZ/%** position and insert the red test lead banana plug into the **10A** jack.
5. Press the **MODE** button to indicate “**AC**” on the display.
6. Remove power from the circuit under test, then open up the circuit at the point where you wish to measure current.
7. Touch the black test probe tip to the neutral side of the circuit. Touch the red test probe tip to the “hot” side of the circuit.
8. Apply power to the circuit.
9. Read the current in the display. In the 10AAC range, right auxiliary display frequency.
10. Press and hold the **MODE** button to indicate “**Hz**”.
11. Read the frequency in the display.
12. Momentarily press the **MODE** button again to indicate “**%**”.
13. Read the % duty cycle in the display.
14. Press and hold the **MODE** button to return to current measurement.
10. With ACA in the main display, press EXIT for 2 seconds to measure AC+DC.



RESISTANCE MEASUREMENTS



WARNING: To avoid electric shock, disconnect power to the unit under test and discharge all capacitors before taking any resistance measurements. Remove the batteries and unplug the line cords.

1. Set the function switch to the **Ω CAP** position.
2. Insert the black test lead banana plug into the negative **COM** jack. Insert the red test lead banana plug into the positive **Ω** jack.
3. Press the **MODE** button to indicate “ **Ω** ” on the display.
4. Touch the test probe tips across the circuit or part under test. It is best to disconnect one side of the part under test so the rest of the circuit will not interfere with the resistance reading.
5. Read the resistance in the display.





CONTINUITY CHECK

WARNING: To avoid electric shock, never measure continuity on circuits or wires that have voltage on them.

1. Set the function switch to the Ω CAP  position.
2. Insert the black lead banana plug into the negative **COM** jack. Insert the red test lead banana plug into the positive Ω jack.
3. Press the **MODE** button to indicate "" and " Ω " on the display.
4. Touch the test probe tips to the circuit or wire you wish to check.
5. If the resistance is less than approximately 35Ω , the audible signal will sound. If the circuit is open, the display will indicate "**OL**".



DIODE TEST

1. Set the function switch to the Ω CAP  position.
2. Insert the black test lead banana plug into the negative **COM** jack and the red test lead banana plug into the positive **V** jack.
3. Press the **MODE** button to indicate "" and "**V**" on the display.
4. Touch the test probes to the diode under test. Forward voltage will typically indicate 0.400 to 0.700V. Reverse voltage will indicate "**OL**". Shorted devices will indicate near 0V and an open device will indicate "**OL**" in both polarities.

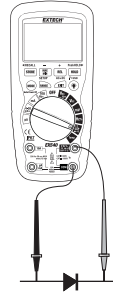

CAPACITANCE MEASUREMENTS

WARNING: To avoid electric shock, disconnect power to the unit under test and discharge all capacitors before taking any capacitance measurements. Remove the batteries and unplug the line cords.

1. Set the rotary function switch to the Ω CAP  position.
2. Insert the black test lead banana plug into the negative **COM** jack.
3. Insert the red test lead banana plug into the positive **V** jack.
4. Press the **MODE** button to indicate "**F**".
5. Touch the test leads to the capacitor to be tested.
6. Read the capacitance value in the display.



TEMPERATURE MEASUREMENTS

1. Set the function switch to the **Temp** position.
2. Insert the Temperature Probe into the input jacks, making sure to observe the correct polarity.
3. Press the **MODE** button to indicate “°F” or “°C”
4. Touch the Temperature Probe head to the part whose temperature you wish to measure. Keep the probe touching the part under test until the reading stabilizes (about 30 seconds).
5. Read the temperature in the display.

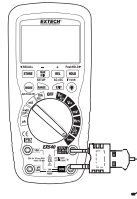

Note: The temperature probe is fitted with a type K mini connector. A mini connector to banana connector adaptor is supplied for connection to the input banana jacks.

FREQUENCY (DUTY CYCLE) MEASUREMENTS (ELECTRONIC)

1. Set the rotary function switch to the **Hz/%** position.
2. Insert the black lead banana plug into the negative **COM** jack and the red test lead banana plug into the positive **Hz** jack.
3. Touch the test probe tips to the circuit under test.
4. Read the frequency on the display.
5. Press the **MODE** button to indicate “%”.
6. Read the % duty cycle in the display.

% 4 – 20mA MEASUREMENTS

1. Set up and connect as described for DC mA measurements.
2. Set the rotary function switch to the **4-20mA%** position.
3. The meter will display loop current as a % with 0mA=-25%, 4mA=0%, 20mA=100%, and 24mA=125%.

AUTORANGING/MANUAL RANGE SELECTION

When the meter is first turned on, it automatically goes into AutoRanging. This automatically selects the best range for the measurements being made and is generally the best mode for most measurements. For measurement situations requiring that a range be manually selected, perform the following:

1. Press the **RANGE** key. The “**AUTO**” display indicator will turn off.
2. Press the **RANGE** key to step through the available ranges until you select the range you want.
3. To exit the Manual Ranging mode and return to Autoranging, press **EXIT**

Note: Manual ranging does not apply for the Temperature functions.

MAX/MIN

1. Press the **MAX/MIN** key to activate the MAX/MIN recording mode. The display icon “**MAX**” will appear. The meter left auxiliary display will display and hold the maximum reading and will update only when a new “max” occurs. The display icon “**MIN**” will appear. The right auxiliary display will display and hold the minimum reading and will update only when a new “min” occurs.
2. To exit MAX/MIN mode press **EXIT**

RELATIVE MODE

The relative measurement feature allows you to make measurements relative to a stored reference value. A reference voltage, current, etc. can be stored and measurements made in comparison to that value. The displayed value is the difference between the reference value and the measured value.

1. Perform the measurement as described in the operating instructions.
2. Press the **REL** button to store the reading in the display and the "▲" indicator will appear on the display.
3. The Right auxiliary display displays the initial reading (the stored value)
4. The Left auxiliary display displays the actual currently measured value.
5. Main display displays the Relative value (currently measured value minus the stored value).

DISPLAY BACKLIGHT

Press the  key to turn the backlight on. The backlight will automatically turn off after SET time. Press the EXIT button to exit the backlight on mode.

HOLD

The hold function freezes the reading in the display. Press the **HOLD** key momentarily to activate or to exit the **HOLD** function.

PEAK HOLD

The Peak Hold function captures the peak AC or DC voltage or current. The meter can capture negative or positive peaks as fast as 1 millisecond in duration. Momentarily press the **PEAK** button, "**PEAK**" and "**MAX**" will display in **left auxiliary display**. **MIN** will display in **right auxiliary display**. The meter will update the display each time a lower negative peak occurs. **Press the EXIT button to exit the PEAK HOLD mode.** Auto Power Off feature will be disabled automatically in this mode.

DATA STORAGE

1. Set the function switch to the measurement function desired.
2. Press the STORE button to enter the STORE function. The left upper aux display indicates the current storage location (0000 to 9999). New measurements will begin storing into the next location.
3. Press the PEAKHOLD button to change into the initial storage number 0000. (Press it again to change back). On the right upper aux display shows XXXX which states how many current storage locations are used.
4. Press STORE button again to enter into recording interval time set up function.
5. The left upper aux display indicates 0000 S, which is the recording sample rate; use the + & - buttons to select the sample rate desired (0 to 255 sec)
6. Set the sample rate to 0000 S for manual recording. In this mode, each press of the STORE button will save one measurement reading.
7. Set the sample rate to 1 to 255 S for automatic recording. In this mode, pressing the STORE button will start data recording at the set sample rate.
8. Press the EXIT button to end the recording session.

DATA STORAGE RECALL

1. Press STORE button for two seconds to enter into RECALL function.
2. On the left upper aux display will show XXXX, which is the current storage location. The right aux display will show XXXX, which is the number of storage locations currently used.
3. Press the + or — button to select the storage location. The value in that location will be indicated in the main display.
4. Press the PEAKHOLD button once to continuously scan data from 0000 to XXXX. Press again then scan again.
5. Press the EXIT button to end the recall session.

CLEARING MEMORY

To clear the memory of all stored data, from the OFF position, hold the EXIT button and switch the function switch to any position. Release the EXIT button and the LCD will flash 3 times and a buzzer will beep three times. Memory is now clear.

PC WIRELESS COMMUNICATION:

1. Install and launch the pc software
2. Press and Hold the backlight button for two seconds to enter RF wireless transmit mode.
3. The RF icon  will appear on the display.
4. When communication is established, the RF icon on the display will blink and the led indicator on the receiver will also blink.
5. Once per second, the data will be displayed on the pc screen, plotted and inserted into a list.
6. Hold the backlight button for two seconds to exit the RF wireless transmit mode

SENDING STORED DATA TO THE PC

1. Launch the pc software
2. Press the STORE button for two seconds to enter into data RECALL function.
3. Press the HOLD button for two seconds. The RF transmit icon will flash while the stored data is sent to the pc

SETUP

1. Press and Hold the RANGE/SETUP button for two seconds to enter the SET function. The first of five settable functions will appear.
2. Press the RANGE button to step through the functions
A: Upper limit buzzer alarm OFF or Value
B: Lower limit buzzer alarm OFF or Value
C: Auto power off time OFF, 10 to 30 sec
D: Button beeper ON/OFF
E: Back light time OFF, 10 to 30 sec
Use the +, - ◀, and ▶ buttons to select and change conditions and digits.
3. Press the RANGE/SETUP button until the meter returns to the normal display to exit this mode.

AC+DC

In the measuring modes VAC, mV(AC), 10A(AC), mA(AC) and uA(AC), press the EXIT button for 2 seconds to enter into AC+DC testing. The precision is the same as in the AC measure modes. The LCD shows AC+DC icon. Press the EXIT button to exit the mode.

LOW BATTERY INDICATION

When the  icon appears in the display, the battery should be replaced

Maintenance

WARNING: To avoid electric shock, disconnect the test leads from any source of voltage before removing the back cover or the battery or fuse covers.

WARNING: To avoid electric shock, do not operate your meter until the battery and fuse covers are in place and fastened securely.

This MultiMeter is designed to provide years of dependable service, if the following care instructions are performed:

1. **KEEP THE METER DRY.** If it gets wet, wipe it off.
2. **USE AND STORE THE METER IN NORMAL TEMPERATURES.** Temperature extremes can shorten the life of the electronic parts and distort or melt plastic parts.
3. **HANDLE THE METER GENTLY AND CAREFULLY.** Dropping it can damage the electronic parts or the case.
4. **KEEP THE METER CLEAN.** Wipe the case occasionally with a damp cloth. DO NOT use chemicals, cleaning solvents, or detergents.
5. **USE ONLY FRESH BATTERIES OF THE RECOMMENDED SIZE AND TYPE.** Remove old or weak batteries so they do not leak and damage the unit.
6. **IF THE METER IS TO BE STORED FOR A LONG PERIOD OF TIME,** the batteries should be removed to prevent damage to the unit.

BATTERY INSTALLATION

WARNING: To avoid electric shock, disconnect the test leads from any source of voltage before removing the battery cover.

1. Turn power off and disconnect the test leads from the meter.
2. Open the rear battery cover by removing two screws (B) using a Phillips head screwdriver.
3. Insert the battery into battery holder, observing the correct polarity.
4. Put the battery cover back in place. Secure with the screws.
- 5.



You, as the end user, are legally bound (**EU Battery ordinance**) to return all used batteries, **disposal in the household garbage is prohibited!** You can hand over your used batteries / accumulators at collection points in your community or wherever batteries / accumulators are sold!

Disposal: Follow the valid legal stipulations in respect of the disposal of the device at the end of its lifecycle

WARNING: To avoid electric shock, do not operate the meter until the battery cover is in place and fastened securely.

NOTE: If your meter does not work properly, check the fuses and batteries to make sure that they are still good and that they are properly inserted.

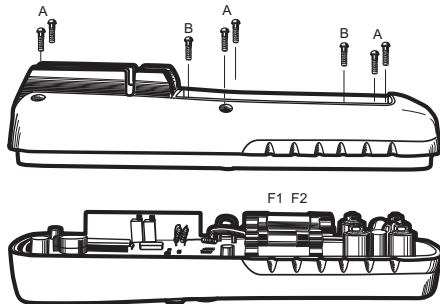

REPLACING THE FUSES

WARNING: To avoid electric shock, disconnect the test leads from any source of voltage before removing the meter cover.

1. Disconnect the test leads from the meter.
2. Remove the protective rubber holster.
3. Remove the battery cover (two "B" screws) and the battery.
4. Remove the six "A" screws securing the rear cover.
5. Gently remove the old fuse and install the new fuse into the holder.
6. Always use a fuse of the proper size and value (0.5A/1000V fast blow for the 400mA range [SIBA 70-172-40], 10A/1000V fast blow for the 20A range [SIBA 50-199-06]).
7. Replace and secure the rear cover, battery and battery cover.

WARNING: To avoid electric shock, do not operate your meter until the fuse cover is in place and fastened securely.

FCC Part 15

This equipment has been tested and found to comply with the limits for a Class B digital device, pursuant to part 15 of the FCC Rules. These limits are designed to provide reasonable protection against harmful interference in a residential installation. This equipment generates, uses and can radiate radio frequency energy and, if not installed and used in accordance with the instructions, may cause harmful interference to radio communications. However, there is no guarantee that interference will not occur in a particular installation. If this equipment does cause harmful interference to radio or television reception, which can be determined by turning the equipment off and on, the user is encouraged to try to correct the interference by one or more of the following measures:

- Reorient or relocate the receiving antenna.
- Increase the separation between the equipment and receiver.
- Connect the equipment into an outlet on a circuit different from that to which the receiver is connected.
- Consult the dealer or an experienced radio/TV technician for help.

Warning: Changes or modifications not expressly approved by the party responsible for compliance could void the user's authority to operate the equipment.

Specifications

Function	Range	Resolution	Accuracy
DC Voltage	400mV	0.01mV	±(0.06% reading + 2 digits)
	4V	0.0001V	
	40V	0.001V	
	400V	0.01V	
	1000V	0.1V	±(0.1% reading + 2 digits)
AC Voltage (AC+DC) 50 to 1000Hz	400mV	0.01mV	±(1.0% reading + 4digits)
	4V	0.0001V	±(1.0% reading + 3digits)
	40V	0.001V	
	400V	0.01V	
	1000V	0.1V	
	All AC voltage ranges are specified from 5% of range to 100% of range		
DC Current	400μA	0.01μA	±(1.0% reading + 3 digits)
	4000μA	0.1μA	
	40mA	0.001mA	
	400mA	0.01mA	
	10A	0.001A	
	(20A: 30 sec max with reduced accuracy)		
AC Current (AC+DC) 50 to 1000Hz	400μA	0.01μA	±(1.5% reading + 3 digits)
	4000μA	0.1μA	
	40mA	0.001mA	
	400mA	0.01mA	
	10A	0.001A	
	(20A: 30 sec max with reduced accuracy)		
All AC voltage ranges are specified from 5% of range to 100% of range			

NOTE: Accuracy is stated at 65°F to 83°F (18°C to 28°C) and less than 75% RH.

Function	Range	Resolution	Accuracy
Resistance	400Ω	0.01Ω	±(0.3% reading + 9 digits)
	4kΩ	0.0001kΩ	±(0.3% reading + 4 digits)
	40kΩ	0.001kΩ	
	400kΩ	0.01kΩ	
	4MΩ	0.001MΩ	
	40MΩ	0.001MΩ	±(2.0% reading + 10 digits)
Capacitance	40nF	0.001nF	±(3.5% reading + 40 digits)
	400nF	0.01nF	
	4μF	0.0001μF	±(3.5% reading + 10 digits)
	40μF	0.001μF	
	400μF	0.01μF	
	4000μF	0.1μF	±(5% reading + 10 digits)
40mF	0.001mF		
Frequency (electronic)	40Hz	0.001Hz	±(0.1% reading + 1 digits)
	400Hz	0.01Hz	
	4kHz	0.0001kHz	
	40kHz	0.001kHz	
	400kHz	0.01kHz	
	4MHz	0.0001MHz	
	40MHz	0.001MHz	
	100MHz	0.01MHz	Not specified
Sensitivity: 0.8V rms min. @ 20% to 80% duty cycle and <100kHz; 5Vrms min @ 20% to 80% duty cycle and > 100kHz.			
Frequency (electrical)	40.00HZ-4KHz	0.01HZ to 0.001KHz	±(0.5% reading)
	Sensitivity:5Vrms		
Duty Cycle	0.1 to 99.90%	0.01%	±(1.2% reading + 2 digits)
	Pulse width: 100μs - 100ms, Frequency: 5Hz to 150kHz		
Temp (type-K)	-58 to 1382°F	0.1°F	±(1.0% reading + 4.5°F)
	-50 to 750°C	0.1°C	±(1.0% reading + 2.5°C) (probe accuracy not included)
4-20mA%	-25 to 125%	0.01%	±50 digits
	0mA=-25%, 4mA=0%, 20mA=100%, 24mA=125%		

Note: Accuracy specifications consist of two elements:

- (% reading) – This is the accuracy of the measurement circuit.
- (+ digits) – This is the accuracy of the analog to digital converter.

Enclosure	Double molded, waterproof (IP67)
Shock (Drop Test)	6.5 feet (2 meters)
Diode Test	Test current of 0.9mA maximum, open circuit voltage 2.8V DC typical
Storage capacity	9999 records
RF transmit distance	10 meters (approx)
Transmitter Frequency	915MHz
Continuity Check	Audible signal will sound if the resistance is less than 35Ω (approx.), test current <0.35mA
Peak	Captures peaks >1ms
Temperature Sensor	Requires type K thermocouple
Input Impedance	>10MΩ VDC & >9MΩ VAC
AC Response	True rms
ACV Bandwidth	50Hz to 1000Hz
Crest Factor	≤3 at full scale up to 500V, decreasing linearly to ≤1.5 at 1000V
Display	40,000 count, backlit, liquid crystal with bargraph
Overrange indication	"OL" is displayed
Auto Power Off	15 minutes (approximately) with disable feature
Polarity	Automatic (no indication for positive); Minus (-) sign for negative
Measurement Rate	2 times per second, nominal
Low Battery Indication	"  " is displayed if battery voltage drops below operating voltage
Battery	One 9 volt (NEDA 1604) battery
Fuses	mA, μA ranges; 0.5A/1000V ceramic fast blow A range; 10A/1000V ceramic fast blow
Operating Temperature	41°F to 104°F (5°C to 40°C)
Storage Temperature	-4°F to 140°F (-20°C to 60°C)
Operating Humidity	Max 80% up to 87°F (31°C) decreasing linearly to 50% at 104°F (40°C)
Storage Humidity	<80%
Operating Altitude	7000ft. (2000meters) maximum.
Weight	0.753lb (342g) (includes holster).
Size	7.36" x 3.2" x 2.0" (187 x 81 x 50mm) (includes holster)
Safety	This meter is intended for origin of installation use and protected, against the users, by double insulation per EN61010-1 and IEC61010-1 2 nd Edition (2001) to Category IV 600V and Category III 1000V; Pollution Degree 2. The meter also meets UL 61010-1, 2 nd Edition (2004), CAN/CSA C22.2 No. 61010-1 2 nd Edition (2004), and UL 61010B-2-031, 1 st Edition (2003)