

[Visit us at www.TestEquipmentDepot.com](http://www.TestEquipmentDepot.com)

[Back to the Extech 42280 Product Info Page](#)

User Guide

EXTECH[®]
INSTRUMENTS

Temperature and Humidity Datalogger

Model 42280

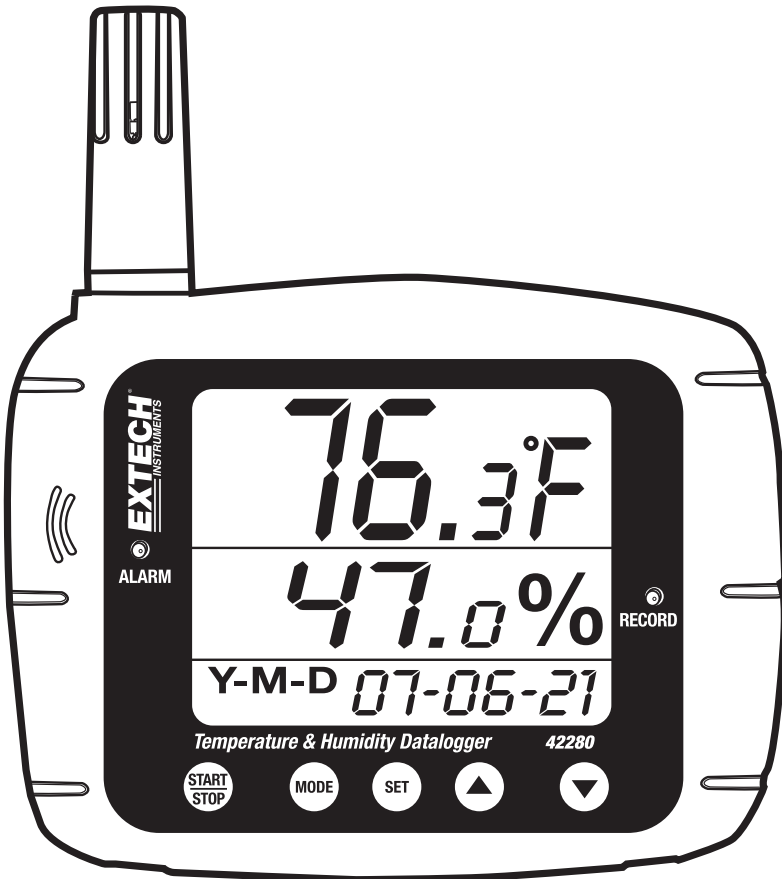

Introduction

Congratulations on your purchase of the Extech 42280 Thermometer and Relative Humidity Datalogger. The 42280 is a wall-mount, tripod mount, or desktop indoor air quality monitor with an internal memory capable of storing 16,000 readings (8000 temperature readings and 8000 relative humidity readings) that can later be transferred to PC using the USB interface. Real-time meter-to-PC logging is also supported. This meter is shipped fully tested and calibrated and, with proper use, will provide years of reliable service.

Material list

Supplied Materials

- Meter
- User Guide
- USB cable
- Program CD
- Four (4) batteries; 1.5V 'AA'

Optional accessories

- 9V adaptor
- Calibration bottles (33% and 75%) for Relative Humidity Calibration

Features

- Large LCD display shows temperature, humidity, and date/time clock simultaneously
- 16,000 internal memory capacity (8000 temperature; 8000 RH%)
- Visual and Audible (with 117V AC adaptor only) Alarms
- Easily configure datalogger through the keypad or via PC interface
- USB PC interface with Windows™ software
- Wall mount, tripod mount, or for desktop use

Test Equipment Depot - 800.517.8431 - 99 Washington Street Melrose, MA 02176
FAX 781.665.0780 - TestEquipmentDepot.com

Description

Meter Description

1. Humidity Sensor (internal Temperature sensor)
2. Audible alarm (with AC adaptor power only)
3. Visual Alarm LED
4. Relative Humidity display
5. Date and Time display
6. Temperature display
7. RECORD status LED
8. USB port
9. AC Adaptor jack
10. Datalogger START-STOP button
11. MODE button
12. SET button
13. Up Arrow button
14. Down Arrow button
15. Tripod mount jack

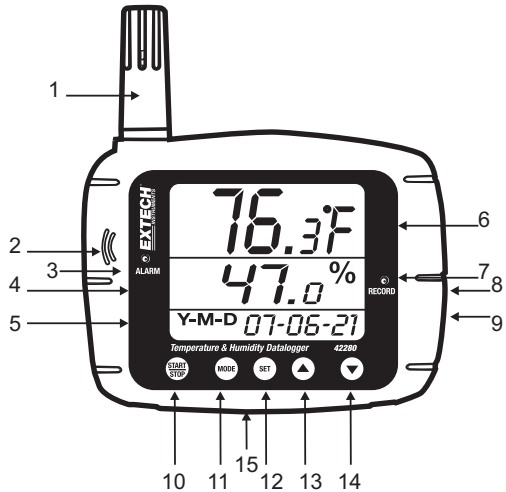

Notes: The battery compartment is located on rear of instrument. Desktop stand footers are not shown in diagram.

LCD Display Description

1. Temperature Display
2. Dew Point icon
3. Datalogger icon
4. Date and Time
5. Humidity Display
6. Low battery icon

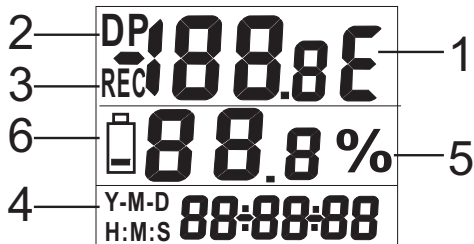

Operation

Important Note before starting

This meter relies on firm button presses to operate correctly. Be sure to press firmly and hold the button for as long as directed in the instructions.

Meter Power

1. The meter is powered by four (4) 'AA' 1.5V batteries or the 117V AC adaptor.
2. When the batteries are installed or the adaptor is connected to an AC power source, momentarily press the START-STOP button to turn the meter ON.
3. Press the START-STOP button again to turn the meter OFF.

Viewing the displayed readings

1. Normally, the top line indicates temperature in degrees C or F. Use the MODE button to switch between degrees C and degrees F.
2. Press and hold the MODE for at least 2 seconds. This will change the top display to Dew Point temperature. The 'DP' icon will appear on the LCD when in Dew Point mode. Press and hold the MODE button for at least 2 seconds to return the top display to the normal temperature display mode.
3. The middle line displays Relative Humidity in %.
4. The bottom line automatically alternates between Time and Date displays.
5. If the ALM status LED illuminates and the display flashes, one of the Alarm limits has been reached. Program the High and Low Temperature/Humidity limits in Programming parameter P5 (detailed later in this user guide).

Datalogger Basics

The Model 42280 has a built-in Datalogger that can store up to 8000 temperature and 8000 humidity readings. Readings can be stored in the meter and transferred at a later time to a PC. The meter can also display real-time readings on a connected PC; in other words, the PC can display readings at the instant the readings are taken.

The meter must be configured before datalogging can be attempted. Parameters such as Real Time Clock and Datalogger Sample Rate must be programmed before datalogging can begin. It is strongly recommended that the user take advantage of the supplied software to configure the meter. Instructions for manually configuring the meter are provided below; however configuring the meter via software is very convenient.

Basic instructions for connecting the meter to a PC and getting started with the supplied software are provided later in this guide. Detailed instructions regarding the supplied software are provided in a separate manual included on the supplied CD-ROM and the HELP utility in the software program.

Manual Programming

The Model 42280 has several programming modes (P1, P2, P3, P4, P5, and P6). These parameters must be programmed before the Datalogger or the Alarm can be used.

List of Programming Modes

- P1** - Number of samples to record (1, 2, 4, 8, 12, or 16 x 1000; 1=1000, 2=2000, etc.)
- P2** - Datalogging Start Methods (Immediate, Keypad, Scheduled, and Repeat modes)
- P3** – Start Time (set the time and date when Datalogging will automatically begin);
Note that P3 will not appear in the menu if 'Sch' is not selected in P2.
- P4** - Sample Rate (set the datalogging interval from 1 second up to 12 hours)
- P5** - Alarm Mode (set High and Low Temperature/Humidity limits)
- P6** - Real Time Clock (set the meter's internal date and time clock)

Programming Mode P1; Number of readings (sample points) to record

1. Press the SET button to access the setup mode
2. Use the arrow buttons to select parameter P1 (see sample display below)
3. Press the SET button again
4. Use the up/down arrow buttons to select the desired number of samples (in thousands) to record for a datalogging session (1, 2, 4, 8, 12, or 16; where 1=1000, 2=2000, 4=4000, and so on)
5. Press the SET button to save setting
6. Use the arrow buttons to select another programming mode or press MODE to exit the programming mode.

Pt 5	Pt 5
P1	16h

Programming Mode P2; Datalogger Start Modes

1. Press the SET button to access the setup mode
2. Use the arrow buttons to select parameter P2
3. Press the SET button again
4. Select one of the four Start modes using the up/down arrow buttons (see list and diagram below)
 - a. **rEp** (Repeat Start mode):
Logger starts once readings are downloaded to PC
 - b. **hEy** (Keypad Start):
Datalogging begins after the START/STOP button is held for 2 seconds
 - c. **imm** (Immediate Start):
Recording starts immediately after exiting the setup mode
 - d. **SCh** (Scheduled Start):
Logging begins at a preset date and time
5. Press the SET button to save the setting
6. Use the arrow buttons to select another programming mode or press MODE to exit the programming mode.

S t n
P 2

S t n
r E P

S t n
h E y

S t n
, n n

S t n
S C h

Programming Mode P3; Datalog Start Time

Note that parameter P3 will only be visible if the Start MODE is set to SHCEDULE (Parameter P2 set to 'Sch').

1. Press the SET button to access the setup mode
2. Use the arrow buttons to select parameter P3
3. Press the SET button again
4. Use the up/down arrow buttons to set the year
5. Press the SET button again
6. Use the up/down arrow buttons to set month
7. Press the SET button again
8. Use the up/down arrow buttons to set the day
9. Press the SET button again
10. Use up/down buttons to set the hours
11. Press the SET button again
12. Use up/down buttons to set the minutes
13. Press the SET button again
14. Use the up/down arrow buttons to set the seconds
15. Press the SET button again to store the settings
16. Press the MODE button to back out to the top level of this menu.
17. Use the arrow buttons to select another programming mode or press MODE to exit the programming mode.

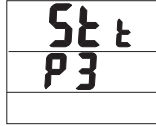

8

Programming Mode P4; Datalogger Sample Rate

1. Press the SET button to access the setup mode
2. Use the arrow buttons to select parameter P4
3. Press the SET button again
4. Use the up/down arrow buttons to set hours
5. Press the SET button again
6. Use the up/down arrow buttons to set the minutes
7. Press the SET button again
8. Use the up/down arrow buttons to set the seconds
9. Press SET again to store the settings
10. Press the MODE button to back out to the top level of this menu.
11. Use the arrow buttons to select another programming mode or press MODE to exit the programming mode.

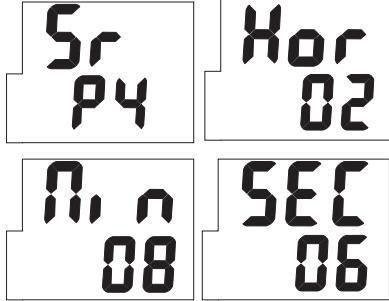

Programming Mode P5; High and Low Alarms

1. Press the SET button to access the setup mode
2. Use the arrow buttons to select parameter P5
3. Press the SET button again
4. Use the up/down arrow buttons to set the High Temperature Alarm limit
5. Press the SET button again
6. Use the up/down arrow buttons to set the Low Temperature Alarm limit
7. Press the SET button again
8. Use the up/down arrow buttons to set the High Humidity Limit
9. Press the SET button again
10. Use the up/down arrow buttons to set the Low Humidity Limit
11. Press the SET button again to store the settings
12. Press the MODE button to back out to the top level of this menu.
13. Use the arrow buttons to select another programming mode or press MODE to exit the programming mode.

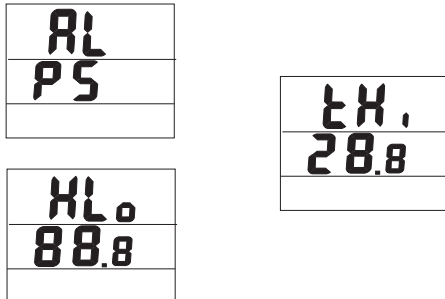

Note: The AC Adaptor must be used for the audible alarm to sound

Programming Mode P6; Real Time Clock

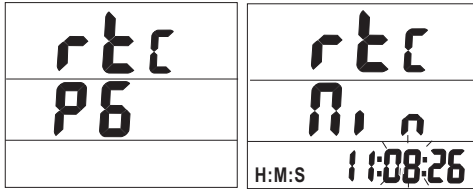

1. Press the SET button to access the setup mode
2. Use the arrow buttons to select parameter P6
3. Press the SET button again
4. Use the up/down arrow buttons to set the year
5. Press the SET button again
6. Use the up/down arrow buttons to set month
7. Press the SET button again
8. Use the up/down arrow buttons to set the day
9. Press the SET button again
10. Use the up/down arrow buttons to set the hours
11. Press the SET button again
12. Use the up/down arrow buttons to set the minutes
13. Press the SET button again
14. Use the up/down arrow buttons to set the seconds
15. Press SET again to stores the settings
16. Press the MODE button to back out to the top level of this menu.
17. Use the arrow buttons to select another programming mode or press MODE to exit the programming mode.

Datalogging

Starting a Datalogging session

The 42280 can automatically store up to 16,000 readings (8000 temperature and 8000 humidity) for later transfer to PC. Program the controller, as discussed earlier, before Datalogging. If the Datalogger has not been configured at this point, configure as necessary. If programming is complete, continue with the next section.

Starting the Datalogger by push-button (Key Mode)

1. Programming mode P2 (Datalogging Start Modes) must be set to KEY (hEy) mode for this method.
2. When P2 is set to 'hEy', press and hold the START-STOP button for 2 seconds.
3. The REC front-panel status light will blink indicating that readings are currently recording at the rate programmed in parameter P4 (sample rate)
4. To stop recording, press and hold the START-STOP button for at least 2 seconds. The REC status light will stop blinking.

Starting the Datalogger in Immediate Mode

1. Programming mode P2 (Datalogging Start Modes) must be set to 'Imm' mode for this method.
2. When the programming mode is exited, Datalogger automatically begins.
3. The REC front-panel status light will blink indicating that readings are currently recording.
4. To stop recording, press and hold the START-STOP button for at least 2 seconds. The REC status light will stop blinking.

Starting the Datalogger in Schedule Mode

1. In Schedule Mode the meter begins recording at a specific date and time, as programmed by the user.
2. Programming mode P2 (Datalogging Start Modes) must be set to 'Sch' mode for this method.
3. After setting P2 to 'Sch', set the desired time and date in Programming Mode P3 (P3 only appears in the menu when 'Sch' is selected in P2).
4. Datalogging will start at the programmed date and time. Note that the Real Time Clock (Programming Mode P6) must first be set to the current date and time.
5. When datalogging begins, the REC front-panel status light will blink indicating that readings are currently recording at the rate programmed in parameter P4 (sample rate)
6. To stop recording, press and hold the START-STOP button for at least 2 seconds. The REC status light will stop blinking.

Starting the Datalogger in Repeat Mode

In Repeat Mode the meter simply begins datalogging again after readings are downloaded to a PC. This allows the user to maintain the same programming selections time after time. Datalogging is indicated by the flashing REC light as described in the other Start Modes above.

To stop recording, press and hold the START-STOP button for at least 2 seconds. The REC status light will stop blinking.

Connecting the Meter to a PC

A USB cable is provided with the meter. One end of the cable connects to the meter's USB jack and the other end connects to a USB port on the PC.

Running the supplied PC software

The supplied PC software is included on the supplied CD-ROM. Insert the CD into the computer's CD-ROM drive and follow the on-screen prompts and instructions. In the software COM PORT SETTING field, select the COM port to where the meter is connected.

Software Datalogging Parameters

From the main software screen, select LOGGER SET and set the sample rate, sample points, and start mode. These are described in some detail in the separate software manual and the software HELP utility on the supplied CD-ROM. Remember to press 'OK' after changing a setting to ensure that the software processes the changes. The meter is now ready to record.

Transferring readings to PC

1. Connect and run the supplied software as previously described.
2. Press the DOWNLOAD START button on the main software screen to transfer the readings.
3. The separate software instructions supplied in the software's HELP utility explain how to view, graph, save, export and print the downloaded data.

NOTE: The Software's HELP utility provides in-depth software and downloading instructions, which is beyond the scope of this user guide; please refer to the HELP utility in the supplied software program for detailed guidelines and instructions.

Humidity Calibration

1. Turn on the meter and plug the humidity sensor probe into the 33% Calibration Reference bottle.
2. Simultaneously press and hold the START-STOP and the SET buttons for at least 2 seconds to enter the 33% Calibration mode. The display '32.8%' will begin to flash on the display.
3. Approximately 30 minutes later, the '32.8%' display will stop flashing, indicating that the 33% calibration is complete.
4. Plug the humidity sensor probe into the 75% Calibration Reference bottle.
5. Press and hold the START-STOP button for at least 2 seconds to enter the 75% Calibration mode. The display '75.3%' will begin to flash on the display.
6. Approximately 30 minutes later, the display will stop flashing, indicating that the entire calibration is complete. The meter will automatically return to the normal operating mode.

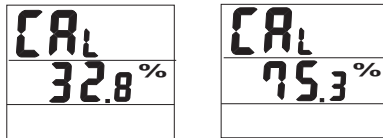

Calibration Notes:

- The user can exit the calibration without finishing by pressing the START-STOP button for 2 seconds (before reaching step 6 above).
- For best accuracy, perform the calibration at room temperature.
- Calibration Reference bottles are available optionally through Extech Instruments distributors

Specifications

General Specifications

Display	Multi-function LCD with status LED indicators
Measurement ranges	Temperature: -4 to 144°F (-20 to 70°C) Humidity: 0 to 100% Dew Point temperature: -4 to 144°F (-20 to 70°C)
Resolution	0.1 °C / °F / %
Accuracy	Temp: +/- 1.0°F (0.6°C) from 32 to 122°F (0 to 50°C) +/-2.0°F (1.2°C) outside of this range Humidity: +/-3% from 10 to 90% (+/-5% outside of this range)
Datalogger memory	16,000 total (8000 temperature and 8000 humidity readings)
Over range indication	Error code appears on the LCD (see Troubleshooting section below for list of codes)
Low battery indication	Battery symbol appears on the LCD
Power supply	Four (4) 1.5v 'AA' batteries

Troubleshooting

Power is ON but there's no display

- Check that the batteries or the AC adaptor is installed and connected properly
- Ensure that the START-STOP button is pressed firmly and for at least 100ms

Calibration Failure

- Check that the batteries or the AC adaptor is installed and connected properly
- Ensure that the calibration bottles are tightly sealed around the meter sensor
- Ensure that calibration takes place at room temperature

Flashing Indicators

- Display flashes in logging mode when the AC adaptor has become unplugged
- DP flashes when temperature is over limit
- Degrees F icon flashes when Humidity is over limit
- REC flashes when datalogging takes place
- ALM light flashes when alarm limit has been exceeded

Error Codes

- E02 - Under flow error
- E03 - Over flow error
- E04 - E02 and E03 combined error
- E11 - CAL error (recalibration required)
- E32 - IC read/write error. Return unit for repair
- E33 - Circuit Error. Return unit for repair



99 Washington Street
Melrose, MA 02176
Phone 781-665-1400
Toll Free 1-800-517-8431

 [Visit us at www.TestEquipmentDepot.com](http://www.TestEquipmentDepot.com)

 [Back to the Extech 42280 Product Info Page](#)

Test Equipment Depot - 800.517.8431 - 99 Washington Street Melrose, MA 02176
FAX 781.665.0780 - TestEquipmentDepot.com