

DPI 605

PRECISION PORTABLE PRESSURE CALIBRATOR

**Test Equipment
Depot**

1-800-517-8431

99 Washington Street
Melrose, MA 02176
Fax 781-665-0780
TestEquipmentDepot.com

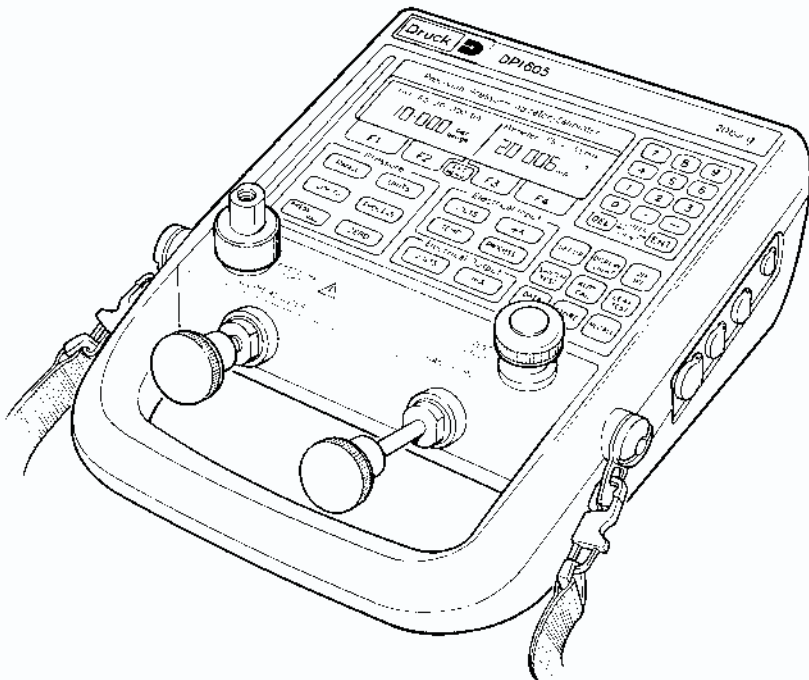

DPI 605 Precision Portable Pressure Calibrator

SAFETY

The Manufacturer has designed this product to be entirely safe when operated correctly.

- Please pay close attention to the Safety Instructions outlined on this page and elsewhere in this manual. They have been designed to protect the User from personal injury and the equipment from damage.



- Potentially hazardous operations are indicated in the text by means of a hazard warning triangle. Specific warnings relating to each section of the manual are given at the beginning of that section.
- Please observe the installation advice and any operational limitations given in this manual.
- This equipment must only be used for the purpose for which it was designed.

Media Compatibility

This equipment is designed to be used with the following media.

Calibrator	-	Gas containing condensing liquid, both non-corrosive.
Indicator	-	Media compatible with stainless steel.

CAUTION: DO NOT USER ANY OTHER MEDIA WITHOUT FIRST CONSULTING DRUCK LIMITED.

Pressure Safety

DO NOT ALLOW pressures greater than the Safe Working Pressure to be applied to the instrument. The specified Safe Working Pressure for the instrument is stated in the Specification section of this manual (Section 1.3).

Electrical Safety

The instrument is designed to be completely safe when used with Options and Accessories supplied by the manufacturer for use with the instrument.

Toxic Materials

During normal operation, it is not possible for the user to come into contact with any hazardous substance which might be employed in the construction of the instrument. The use of hazardous materials in the construction of this instrument has been minimised. Care should however, be exercised during maintenance and the disposal of certain parts:

- A: Memory Back-up Supply** - Employs two batteries containing Lithium, completely sealed within the instrument. When the battery needs replacement, dispose of it as hazardous waste.

Repair and Maintenance

This instrument must be maintained either by the manufacturer or a competent person.

DEFINITIONS

- **Explosive Atmosphere**

A mixture of flammable substance(s) in the form of a gas, vapour or mist mixed with an oxidiser in proportions such that it can be exploded by excessive temperature, arcs or sparking.

- **Hazardous Area**

An area where the presence or possible presence of an explosive atmosphere requires that special precautions are taken to avoid any condition that could ignite the hazard.

- **Safe Area**

An area where no explosion hazard exists at any time.

IMPORTANT

THIS HANDBOOK IS WRITTEN TO SOFTWARE VERSION 3.XX ONLY

The information in this publication includes operating details for software at Version 3.XX. During the power-up routine, the instrument displays the software version number. Any operational changes due to revision of the software will be covered in a new issue of this publication.

1	INTRODUCTION	1-1
1.1	General	1-2
1.2	Applications	1-3
1.3	Instrument Specification	1-4
1.4	Equipment Accessories	1-7
2	FUNCTIONAL DESCRIPTION	2-1
2-1	Installation.....	2-4
2-1.1	Input/Output Connections.....	2-4
2-1.2	Pressure Connections.....	2-4
2-1.3	Electrical Connections.....	2-5
2-1.4	Power/Charger Connections.....	2-5
2-1.5	Battery Removal and Replacement.....	2-6
2-1.6	Communication Interface Connections.....	2-12
2-1.7	Conection of External Transducers.....	2-13
2-1.8	Digital Multimeter Connections.....	2-14
2-1.9	Electrical Input/Output Connections.....	2-16
2-1.10	Temperature Probe Connections.....	2-17
3	FAMILIARISATION	3-1
3.1	Equipment Controls, Indicators and Connectors	3-1
3.2	Pneumatics	3-3
3.3	Electrical Connections	3-6
3.4	Display	3-7
3.5	Keyboard	3-8
3.6	Function Keys	3-9
3.7	Numeric Keys	3-10
3.8	Pressure Key Functions	3-10
3.9	Electrical Input Key Functions	3-12
3.10	Electrical Output Key Functions	3-15
3.11	Mode Select Keys - (Blue Keys)	3-20
3.11.1	On/Off	3-20
3.11.2	Display Light	3-20
3.11.3	Set-up	3-20
	Defaults	3-20
	Comms	3-22
	Clock	3-23
	Printer	3-23
	Contrast	3-23
	Auto Off.....	3-24
	Resolution.....	3-24
	On State.....	3-24
	Temperature Probe	3-25
	Filter	3-25
	Battery	3-25
	Status	3-26
	Cal/Test	3-26
	Keyboard locking Facility	3-26

Test Equipment Depot - 800.517.8431 - 99 Washington Street Melrose, MA 02176

FAX 781.665.0780 - TestEquipmentDepot.com

3.11.4	Switch Test	3-28
3.11.5	Data Log	3-28
	Record	3-29
	Selection of Data Log Trigger Mode	3-29
	Replay	3-33
	Graph	3-34
	Print	3-34
	Upload	3-34
	Directory	3-34
	Memory Space	3-35
	Delete	3-36
3.11.6	Leak Test	3-37
3.11.7	Store	3-37
3.11.8	Recall	3-38
3.11.9	AutoCal	3-38
	Test	3-38
	Manual	3-39
	Auto	3-41
	Replay	3-41
	Display	3-42
	Graph	3-42
	Printer	3-42
	Upload	3-43
	Directory	3-43
	Delete	3-44
4	OPERATION	4-1
4.1	Safety	4-1
4.2	General	4-1
4.2.1	Menu Icons	4-2
4.3	Installation	4-2
4.4	Switching ON and OFF	4-3
	Check Battery Status	4-3
	Care of Rechargeable Batteries	4-3
4.5	Instrument Set-up	4-4
4.5.1	First Time Operation	4-5
	Set PIN	4-5
	Instrument Clock Time and Date	4-6
	Display Contrast	4-7
	Auto Off	4-8
	Power	4-8
	Light	4-8
4.5.2	Set-up Units	4-9
4.5.3	Set-up Data Communications	4-11
4.5.4	Select Printer and Print Screen	4-13
4.5.5	Pressure Display Resolution	4-14
4.5.6	Change On-State	4-15
4.6	Generating a Pressure	4-16
4.6.1	Set Pressure Alarm and Safety Limits	4-18

4.6.2	Selection of Pressure Process Functions	4-19
	Tare	4-19
	Peak	4-20
	%F.S	4-21
	Filter	4-21
	Flow	4-22
4.7	Generating a Vacuum	4-22
4.8	Measuring a Pressure	4-23
4.8.1	Connection of External Pressure Transducers	4-24
4.9	Leak Test	4-25
4.10	Generating an Electrical Output	4-26
4.11	Generation of Output Voltages or Currents (Prog. Output)	4-26
4.12	Set an Analogue Output Proportional to an Indicated Measurand	4-27
4.13	Pressure Switch Testing	4-29
4.14	Temperature Measurements	4-31
4.15	Data Log	4-32
4.15.1	Use of Data Log Directory and Delete Utilities	4-33
4.15.2	Data Log Record Operations	4-34
4.15.3	Data Log Replay Operations	4-43
4.16	Use of AutoCal Facility	4-46
4.16.1	Use of the AutoCal Directory and Delete Utilities	4-47
4.16.2	AutoCal Manual Operations	4-49
4.16.3	Replay of AutoCal Log Files	4-52
4.16.4	Auto AutoCal Procedures	4-55
4.17	Use of the RS 232 Port	4-57
	Connection to a Printer	4-57
	Connection to a Computer	4-58
	Upload	4-58
	Dialogue	4-58
4.18	Memory Reset Option	4-59
4.19	De-contamination Procedures	4-60
4.19.1	Flushing the Instrument's Pneumatic System	4-61
5.0	APPLICATIONS	5-1
5.1	Form of Test	5-1
6	CALIBRATION	6-1
6.1	Selection of New P.I.N. Number	6-2
6.2	Instrument Calibration - Pressure	6-3
6.3	Calibration of an External Pressure Transducer	6-7
6.3.1	Two Point Calibration	6-8
6.3.2	Linearity (Multiple Point Cal)	6-9
6.3.3	Temperature Compensation	6-10
6.3.4	External Transducer Parameter Entry	6-11
APPENDIX A AutoCal	
APPENDIX B SCPI Communications Protocol	

NOTE: Abbreviations are the same in the singular and plural.

ac	alternating current
atm	atmosphere
°C	degrees Celsius
°F	degrees Fahrenheit
COM	common
cm²	centimetre squared
contd	continued
dc	direct current
DMM	digital multimeter
DUT	device under test
ENT	enter
FS	full-scale
ft	feet
mH₂O₄	metres of water at 4°C
kg	kilogram
Pa	Pascal
PIN	personal identification number
mA	milli Amperes
mm	milli metres
No.	number
PRESS	pressure
PTX	pressure transmitter
RDG	reading
RS 232	serial data transmission standard
T	tare
VAC	vacuum

1 INTRODUCTION

The primary use of the DPI 605 range of instruments is a ruggedised instrument designed to operate in 'high abuse' environments. The instrument is available in five types.

- Commercial Calibrator
- Commercial Indicator
- Intrinsically Safe Calibrator
- Intrinsically Safe Indicator
- Sub-Rack Mounted Calibrator

With the exception of the rack mounted version, all instruments are portable.

For the commercial instruments, power is supplied by an internal rechargeable battery pack or alternatively, if required by six alkaline D-size cells. A mains power supply adaptor is also supplied as standard. This mains power supply adaptor serves a dual purpose. It allows the instrument to be either powered directly from a mains power supply, whilst recharging its internal battery, or can be used to recharge a spare (optional) battery pack away from the instrument.

A secondary use of the DPI 605 is as a laboratory instrument.

1.1 General

In its calibrator form, the DPI 605 can generate and indicate pressures up to 20 bar gauge. The instrument's primary pressure range, 20 bar gauge (21 bar absolute with the barometric option), can be extended to 700 bar by the use of external transducers.

A digital multimeter (DMM) is built into the instrument to permit the independent monitoring of voltage and current signals.

The instrument has a temperature measurement facility (using an external PT100 platinum resistance probe). An RS 232 interface is also provided.

In addition to the pressure generation facility, the instrument can generate electrical output voltages and currents. These electrical outputs can be programmed to any level within the range of the instrument or be linearly related to any measurand i.e. pressure, voltage, current or temperature, the relationship being programmable by the user.

The intrinsically safe versions of the instrument can only be powered by alkaline batteries. The DPI 605 rack mounted model is mains powered.

1.2 Applications

The DPI 605 calibrator is primarily used for calibrating transducers and systems over the ranges -1 to 20 bar gauge. With the barometric option fitted, the instrument is capable of reading absolute pressures in the range 0 to 21 bar absolute.

Used in conjunction with external transducers, the range of the instrument can be extended to 700 bar. Typical calibration applications are as follows.

- Calibration of.
 - Pressure to voltage devices.
 - Pressure to current devices.
 - Current loop (4-20 mA) pressure display systems.
 - Voltage to pressure transducers.
 - Current to pressure transducers.
 - Pressure to pressure transducers.
 - Pressure to logic (switch) tests.
 - Analogue pressure gauges.

- Direct temperature measurement (optional probe).
 - Temperature range -55°C to 200°C.

- Voltage and current measurement.
 - Voltage (zero to ± 50 V d.c.).
 - Current (zero to ± 55 mA d.c.).

Section 5, Applications, gives details of instrument connections for typical applications.

1.3 Instrument Specification

Pressure Measurement Specification

Operating Pressure Range

-1 to 20 bar gauge.

0 to 21 bar absolute (with optional Barometric Reference Sensor).

Maximum Safe Working Pressure

Calibrator: 25 bar causing negligible calibration change.

Indicator: To 1.25 x full scale causing negligible calibration change.

Pressure Media

Calibrator: Compatible with most common non-corrosive gases.

Indicator: In accordance with transducer specification.

Response

2 readings per second nominal.

Non Linearity, Hysteresis and Repeatability

Positive Pressure

$\pm 0.025\%$ of reading between 200 mbar and 20 bar.

± 0.05 mbar below 200 mbar.

Negative Pressure

$\pm 0.025\%$ of reading between -1 bar to -200 mbar

± 0.05 mbar between 0 and -200 mbar.

Both Positive and Negative Pressure accuracies ± 1 LSD.

Accuracy

Comprises Non-Linearity, Hysteresis and Repeatability as above plus 90 day stability.

$\pm 0.05\%$ of reading between 200 mbar and 20 bar.

± 0.1 mbar below 200 mbar.

Temperature Effects

-1 bar to +20 bar gauge calibrator over -10° to $+40^{\circ}\text{C}$.

The average temperature coefficient $\pm 0.002\%$ of reading per $^{\circ}\text{C}$.

Electrical Specification

Electrical Inputs

Voltage Measurement

0 to ± 50 V d.c. auto-ranging, max. resolution 10 μ V.

Input impedance 10 M Ω .

Accuracy $\pm 0.04\%$ of reading ± 1 digit including 90 day stability.

T.C. $< 0.0075\%$ of reading per $^{\circ}\text{C}$.

Current Measurement

0 to ± 55 mA d.c. resolution 0.001 mA.

Internal resistance nominally 10 Ω .

Accuracy 0.03% of reading ± 1 digit including 90 day stability.

T.C. $< 0.0075\%$ of reading.

Electrical Outputs

Voltage Output*

Programmable floating output in the range 0 to 24 V d.c. max. 50 mA.

Suitable also for current loop energisation and switch testing.

Current Output*

Programmable output in the range 0 to 55 mA d.c. for current display calibrations.

Configured as source, voltage limit 19 V.

Configured as sink, maximum applied voltage 30 V, minimum applied voltage 5 V.

Analogue Output Signal*

Voltage or current output proportional to any measurand i.e. pressure, voltage, current or temperature.

Output ranges as for programmable outputs.

User programmable zero and full scale settings.

Bandwidth 1 to 2Hz (updated with each new displayed reading).

Resolution 16 bits.

***These facilities are mutually exclusive.**

Digital Interface

RS 232 serial interface for stored data output to host computer or printer and down loaded test routines (electrically isolated from the instrument).

Power Supply

Calibrator and indicator supplied fitted with Ni-Cad rechargeable pack.
Can also be powered by 6 x D cells, alkaline recommended.

Battery life: 20 hours nominal for Ni-Cad.
 70 hours nominal for alkaline.

External PSU/charger unit supplied as standard.

Environmental Specification**Temperature**

Operating: -10° to +40°C.
Storage: -20° to +60°C.

Sealing

Instrument IP65.
Battery charger to laboratory standard.

Electro Magnetic Compatibility

Designed to meet EN50081-1 and EN50082-1.

Physical Specification**Dimensions**

140 mm x 280 mm x 370 mm.

Pressure Connections

G¹/₈ female and removable and ¹/₈ NPT female supplied.

Specification - Indicator Version

Specification as for the Calibrator version except:

Operating Pressure Range

Any full scale can be supplied between the ranges listed below.

0 to 70mbar to 0 to 70 bar gauge

0 to 350 bar sealed gauge

350mbar to 350 bar absolute

Gauge versions available with -1 bar gauge option

Accuracy

Ranges 0 to 80mbar to 0 to 70 bar:

±0.05% of reading between 20% to 100% F.S.

±0.01% of F.S. between 0 and 20% F.S.

For -1 bar calibrations, full scale range is defined as the compound range.

Ranges 0 to 71 to 0 to 350 bar:

±0.08% of reading between 20% and 100% F.S.

±0.016% of F.S. between 0 and 20% F.S.

Figures include 90 day stability

Temperature Effects

70mbar to 30 bar internal sensors ±0.003% RDG per °C

1.4 Equipment Accessories

The instrument is supplied together with its standard accessories which are as follows:

Qty.	Item
1	Carrying Case.
1	Power Adaptor/Battery Charger.
1	Set of Test Leads.
1	User Manual (K136).
1	Calibration Certificate.
1	RS 232 Adaptor Lead.

2 FUNCTIONAL DESCRIPTION

Basically, the DPI 605 calibrator consists of a pneumatic assembly which contains the input/output pressure manifold, two digitally characterised pressure transducers and the solenoid operated control valves associated with the pneumatic system. If the barometric option is chosen, a third (resonant type) transducer is fitted to the pneumatic assembly to measure atmospheric (barometric) pressure. Figure 2.1 shows a simplified functional diagram of the instrument.

The electrical outputs from the pressure transducers, representing the pneumatic manifold pressure (input or output pressure) is processed by the micro-controller system to produce a pressure indication on a graphics display.

A digital multimeter (DMM) is incorporated into the instrument to allow external voltages and currents (produced by the devices under test) to be monitored. These electrical inputs are passed via a DMM interface to the micro-controller which processes the incoming signals to provide a digital display of the measured values.

Both the pressure and electrical signals can be processed by the instrument in a number of ways to provide the operational features of the instrument. These features, which are fully described in Section 3, are software controlled by a series of functionally related operations which are written to the display. The interface between the operator and the instrument is via the keyboard.

Four output terminals labelled A, B, C and D can be programmed by the micro-controller, via an output interface, to source or sink electrical currents or to source electrical voltages. These electrical outputs can also be programmed to be proportional to any measurand i.e. pressure, temperature, voltage or current. In addition to providing an electrical output facility, the micro-controller can program combinations of these terminals to accept trigger inputs for its internal Data Logger and pressure switch test functions.

An RS 232 interface provides a communication channel between the instrument and an optional printer or a computer system. In order to avoid earth loop problems, Opto-couplers and transformers are used to make this interface fully floating with respect to the rest of the instrument.

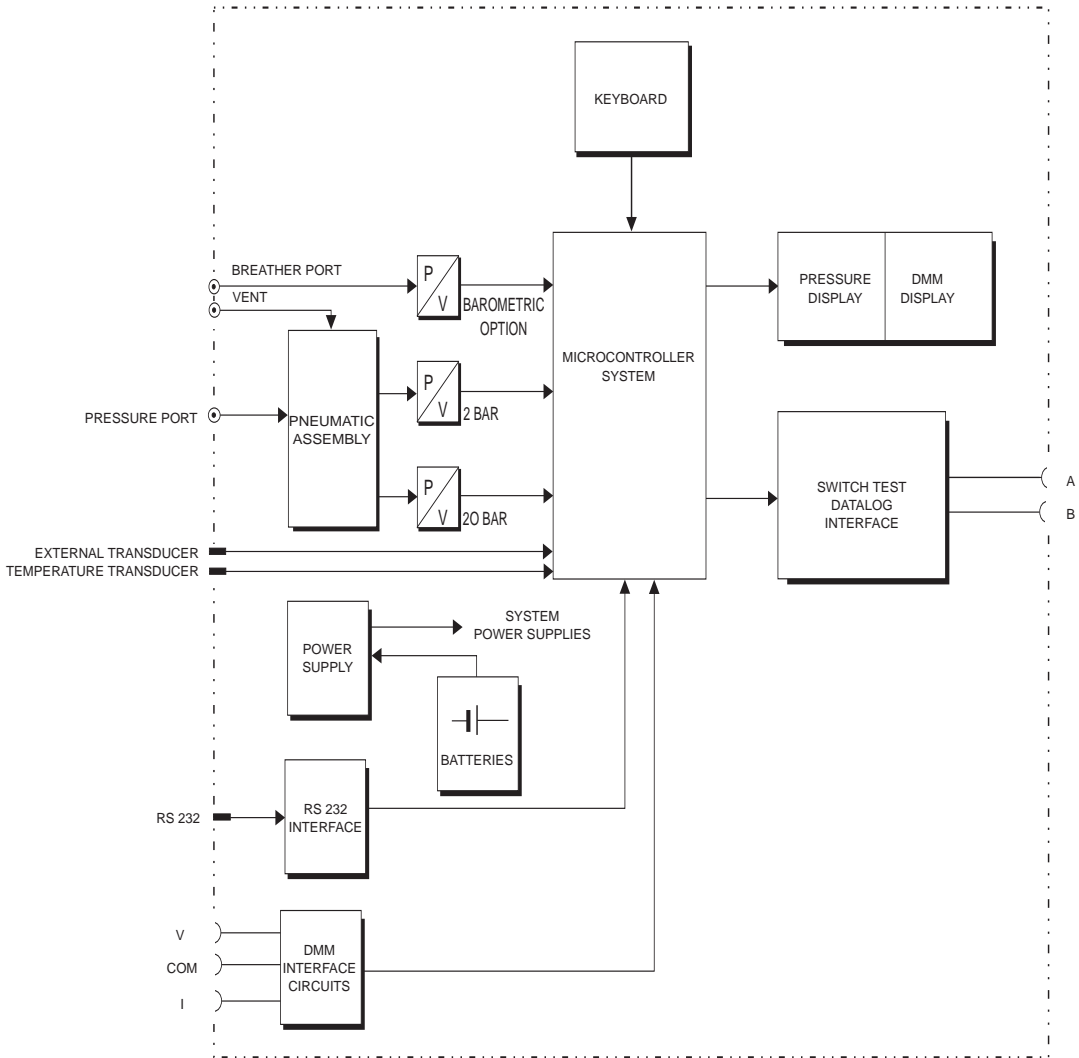

Figure 2.1 - Simplified Functional Diagram - Calibrator Version

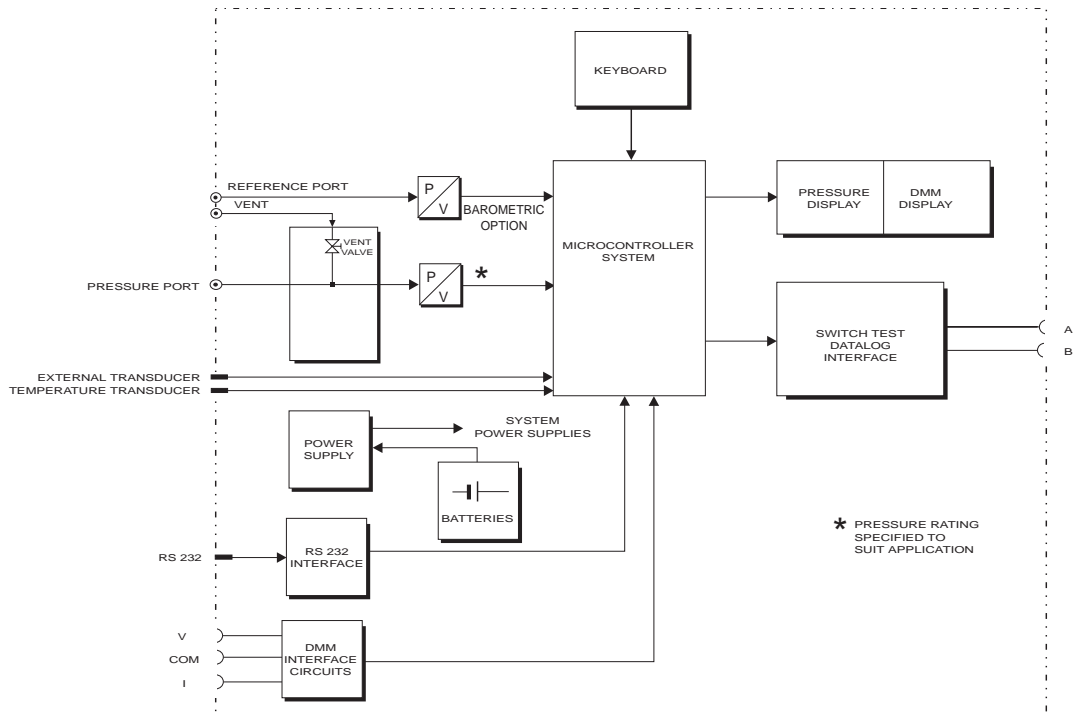

Figure 2.2 - Simplified Functional Diagram - Indicator Version

An internal power unit provides all the regulated supplies that are needed to power the instrument and to source the electrical output signals. A rechargeable battery pack provides the required power supply. An external, plug-in, power adaptor is provided to enable the instrument to be powered from an a.c. mains power supply. If the internal battery pack becomes discharged, the instrument can be powered by inserting six alkaline cells (1.5V D-size), into the battery compartment in place of the rechargeable battery pack.

The DPI 605 indicator operates in a similar manner to the calibrator, differing in that it contains only a single pressure transducer covering the specified pressure range. A second transducer, is only fitted if the Barometric Option is ordered. Figure 2.2 shows a simplified functional diagram of the indicator.

2.1 Installation

2.1.1 Input/Output Connections

Connections to the instrument are made to the appropriate connections as shown in Figure 4.9. Pressure connections are made to the Pressure Port, located on the top of the instrument, and electrical connections to the two side panels.

2.1.2 Pressure Connections

To connect to the measuring port, proceed as follows.

- **Calibrator Versions**

- Open the Vent Valve.
- Fit the pressure output line to the measuring port, fitting a bonded seal between the pressure union and the pressure outlet port. The pressure outlet port uses a G1/8 thread. Ensure that the coupling is tight.

- **Indicator Versions**

- Open the Vent Valve.
- Check that the pressure supply line is isolated before connection to the instrument.
- Fit the pressure supply line to the measuring port, fitting a bonded seal between the pressure union and the pressure outlet port. The pressure outlet port uses a G1/8 thread. Ensure that the coupling is tight.

2.1.3 Electrical Connections

- **Switching ON and OFF**

The instrument is switched on by means of the **ON/OFF** key located on the keyboard. After switch on, a short initiation period follows during which the valves (Calibrator only) are set to the correct states. When the instrument displays pressure and electrical readings it is ready for operation.

A **Low Battery** warning is given when the internal rechargeable battery pack or alkaline batteries (if fitted), are approaching exhaustion. An appropriate operating time of 1 minute is left when the **Battery Low** warning is given.

2.1.4 Power/Charger Connections

The external battery charger plugs into the power socket located on the right hand connector panel. Figure 2.3 details the plug connections. To charge an internally fitted NiCad pack, plug the charger/power adaptor into the power socket located on the right hand side panel of the instrument. It should be noted that the instrument does not need to be switched on in order to charge the internal battery.

A separate Nicad pack can also be charged by directly plugging the charger/power unit into the Lemo connector located on the top of the battery.

Refer to Section 4 for details on caring for rechargeable batteries.

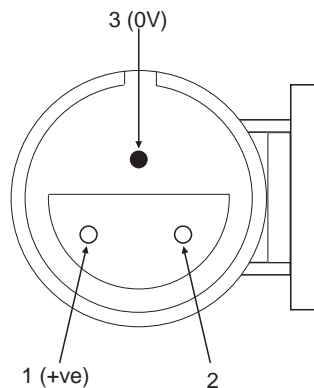
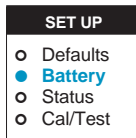

Figure 2.3 - Power/Charger Socket Connections

2.1.5 Battery Removal and Replacement

- **Check Battery Status**

The DPI 605 calibrator and indicator instruments are powered by Alkaline D-Cells. The battery status can be checked from the Setup menu as follows.



- Select Setup by pressing the **Setup** key.
- Select **Battery** (F2) from the Setup menu. The battery status will now be indicated (e.g.),

Battery = 8.24 V Good

- Replace the batteries if Battery Status **Poor** is reported.

- **Battery Removal and Replacement**

The battery compartment for both the DPI 605 calibrator and indicator located in the base of the instrument as shown in Fig. 2.4. Two types of battery compartment are currently in use in these instruments. The following sections cover the battery replacement procedures for each version.

Earlier Versions (to serial number 1606)

- **ENSURE THAT THE EQUIPMENT IS SWITCHED OFF.**
- Turn the instrument over to expose the battery compartment located in the base (refer to Figure 2.4).
- Remove the Battery Cover (1) by unscrewing the Captive Screws (2).
- Carefully lift out the Battery Pack (3) as it is still connected to the instrument.
- Remove the Battery Connector (4) from the socket located on the underside of the battery pack.
- Fit Battery Connector (5) into the replacement battery pack.
- Fit new Battery Pack (3) into the battery compartment.
- Tighten the battery pack Securing Screws (2).

- **Fitting Primary Cells** (*to serial number 1606*)

As an alternative to its own internal rechargeable battery pack, the instrument can be fitted with D-size primary cells. Alkaline cells are recommended. To replace the internal rechargeable battery pack with D-size primary cells, proceed as follows.

- **ENSURE THAT THE EQUIPMENT IS SWITCHED OFF.**
- Turn the instrument over to expose the battery compartment.
- Remove the Battery Cover (1) by unscrewing the Captive Screws (2).
- Carefully lift out the Battery Pack (3) taking care not to strain the Lead (4) and its Connector (5).
- Remove the Battery Connector (5) from the underside of the battery pack and stow the Lead (4) in the well provided in the base of the battery compartment.
- Fit six D-size alkaline cells as shown in Fig. 2.4, observing polarity as indicated.
- Replace the Battery Compartment Cover (2).
- Dispose of exhausted cells thoughtfully, alkaline cells contain toxic materials.

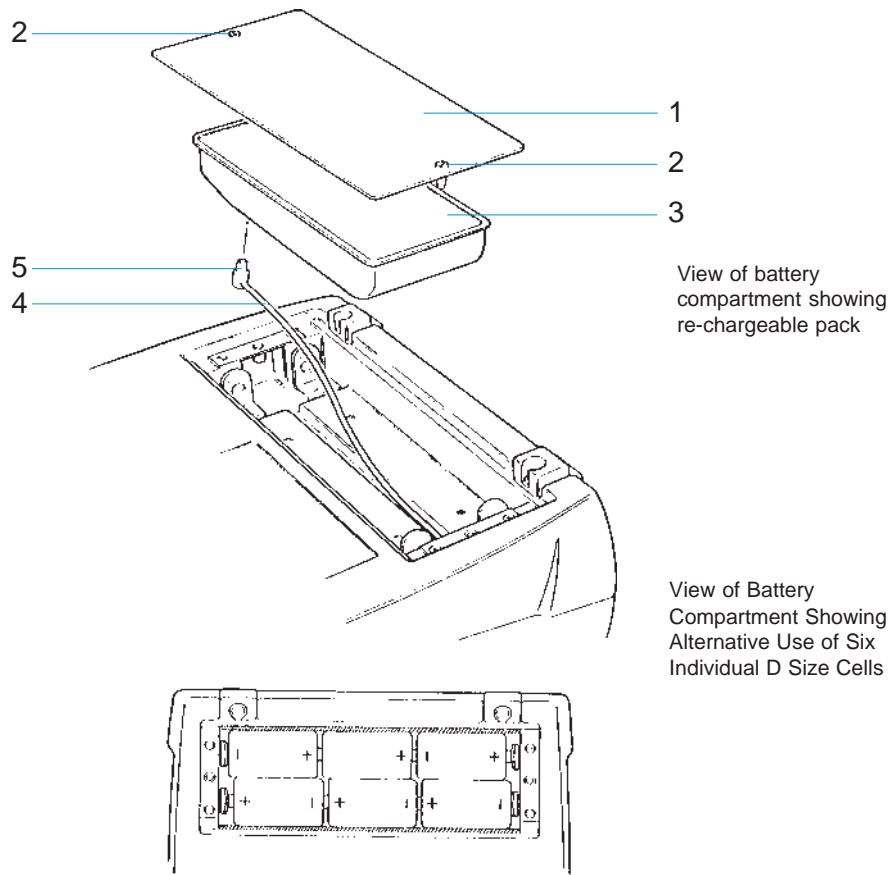

1. Battery Compartment Cover
2. Captive Screws
3. Rechargeable Battery Pack
4. Lead
5. Battery Pack Connector

Figure 2.4 - Battery Removal and Replacement (Early Versions)

- **Battery Pack Removal and Replacement** *(from Serial number 1607)*

On later versions of the instrument, the design of the battery compartment has been changed, the battery to instrument connection being made by directly plugging the battery into a connector located into the base of the instrument (see figure 2.5).

It should be noted that new version battery packs will fit the earlier version instruments but earlier type battery packs will not fit later versions of the instrument.

To exchange a battery pack, proceed as follows (refer to figure 2.5).

- **ENSURE THAT THE EQUIPMENT IS SWITCHED OFF.**
- Turn the instrument over to expose the battery compartment.
- Remove the Battery Cover (1) by unscrewing the Captive Screws (2).
- Carefully lift out the Battery Cover (3) clear of the instrument.
- Slide replacement battery pack into the battery compartment, gently pressing down on the battery to ensure that the base unit and battery connector mate fully.

CAUTION: Do not attempt to force the battery into the connector.

- Replace the Battery Pack Cover (1) and tighten the Captive Screws (2).

- **Fitting Primary Cells** *(from Serial number 1607) [Figure 2.5]*

As an alternative to its internal rechargeable battery pack, the instrument may be fitted with D-size primary cells. Alkaline cells are recommended.

To replace the internal rechargeable battery pack with D-size primary cells, proceed cells.

- **ENSURE THAT THE EQUIPMENT IS SWITCHED OFF.**
- Turn the instrument over to expose the battery compartment.
- Remove the Battery Cover (1) by unscrewing the Captive Screws (2).
- Carefully lift out the rechargeable Battery Pack.
- Fit six D-size alkaline cells as shown in figure 2.5, observing polarity as indicated.
- Replace the Battery Pack Cover (1) and tighten the Captive Screws (2).
- Dispose of exhausted cells thoughtfully; alkaline cells contain toxic materials.

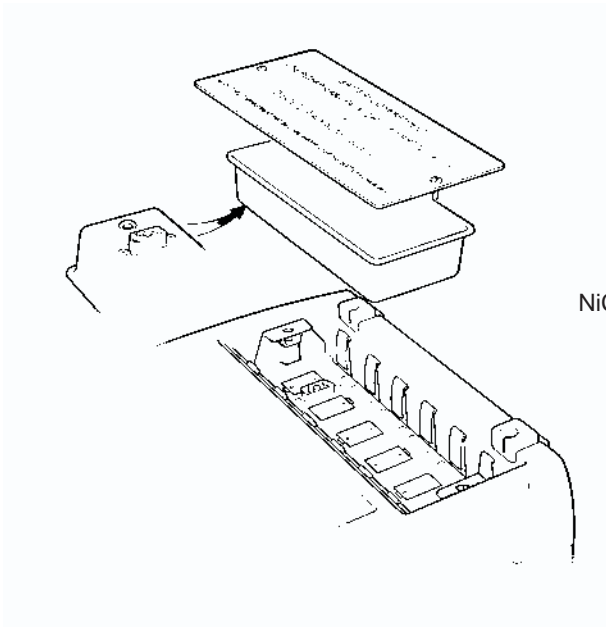

NiCad Pack Removal/Replacement

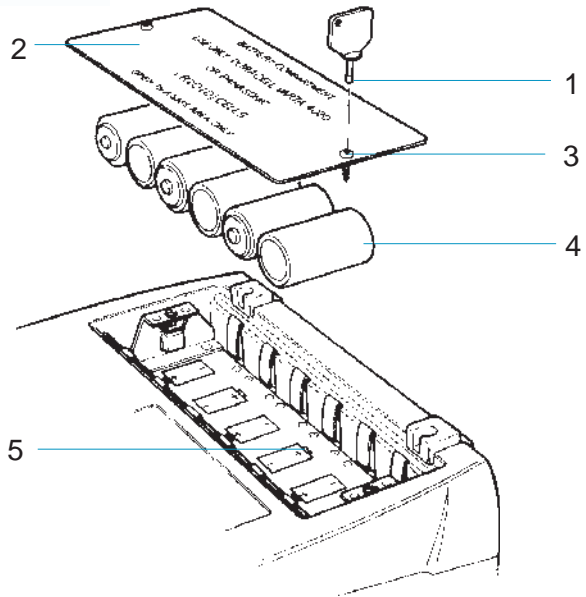

Dry Cell Fitting

1. Key
2. Battery Compartment Cover
3. Tamper Proof Captive Screws
4. Approved Type Alkaline Cells (6 off)*
5. Battery Compartment



USE ONLY APPROVED TYPES OF CELL - REFER TO SECTION 2.1.3, PAGE 2-5.

Figure 2.5 - Battery Removal and Replacement (Later Versions)

2.1.6 Communication Interface Connections

The communications dialogue between the instrument and an external computer system or printer is carried out over an RS 232 interface using the SCPI protocol. The instrument is fitted with a Lemo connector and supplied with a Lemo to 9-pin D-Type adaptor.

Figure 2.6 gives details of the two connector pin-outs and Table 4.1 shows details of the connector interconnections and their relationship to the RS 232 protocol signals.

The instrument is configured as Data Circuit Terminating Equipment (DCE).

Instrument			Control Line		Computer/Printer	
Instrument Function	Connector Type		Signal Direction	RS 232 Terminology	Connector Type	
	Lemo Conn.	9 Way D Pin No.			9 Way D Pin No.	25 Way D Pin No.
RxD(I/P)	1	3	←	TxD	3	2
TxD(O/P)	6	2	→	RxD	2	3
GND	3	5	↔	GND	5	7
CTS (I/P)	2	7	←	RTS	7	4
RTS (O/P)	5	8	→	CTS	8	5
Pulled high internally	4	1	→	RLSD (DCD)	1	8
Not Used	N/C	4	←	DTR	4	20
Pulled high internally	4	6	→	DCR DCE Ready	6	6
Equipment Chassis	Connector Shell	Connector Shell	↔	Cable Screen	-	1

Table 2.1 - RS 232 Connections

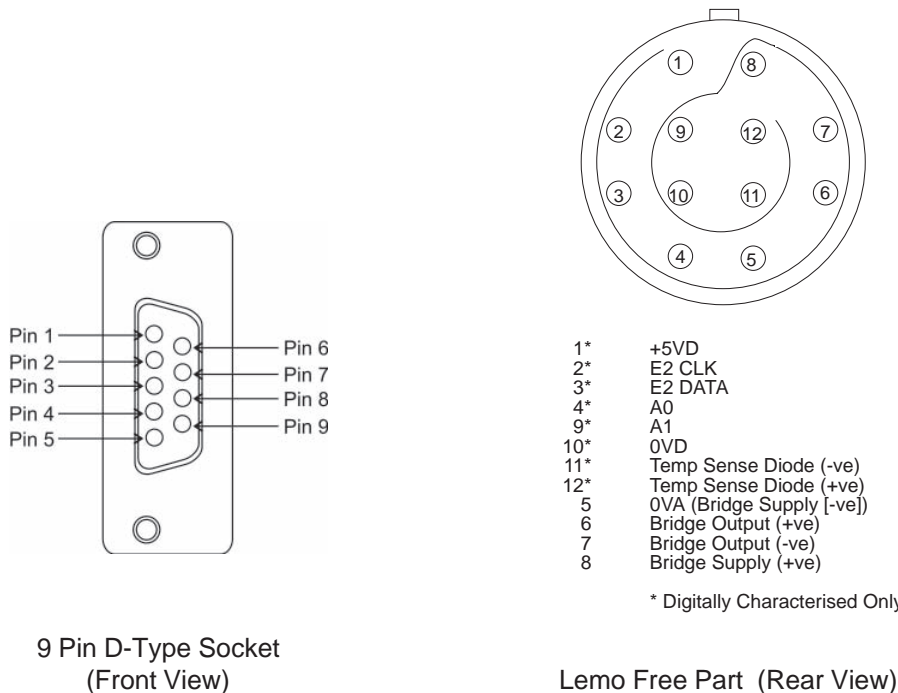

Figure 2.6 - RS 232 Connectors

● **Connection Method**

To connect the RS 232 interface to an external computer system or printer, plug the RS 232 adaptor into the RS232 Lemo socket located on the right hand test panel.

2.1.7 Connection of External Transducers



ENSURE THAT THE EXTERNAL TRANSDUCER TO BE EMPLOYED IS COMPATIBLE WITH THE PRESSURE MEDIA BEING USED.

External transducers ordered as instrument options are delivered terminated with a suitable connector for direct interfacing with the instrument. All Druck supplied External Transducers are approved for use with the DPI 605.

Two types of external Piezo resistive external transducer may be used with the DPI 605, Digitally Compensated and Non-Digitally Compensated. Both types plug directly into the **Ext Transducer** connector. Figure 2.7 shows the pin-out of the connector.

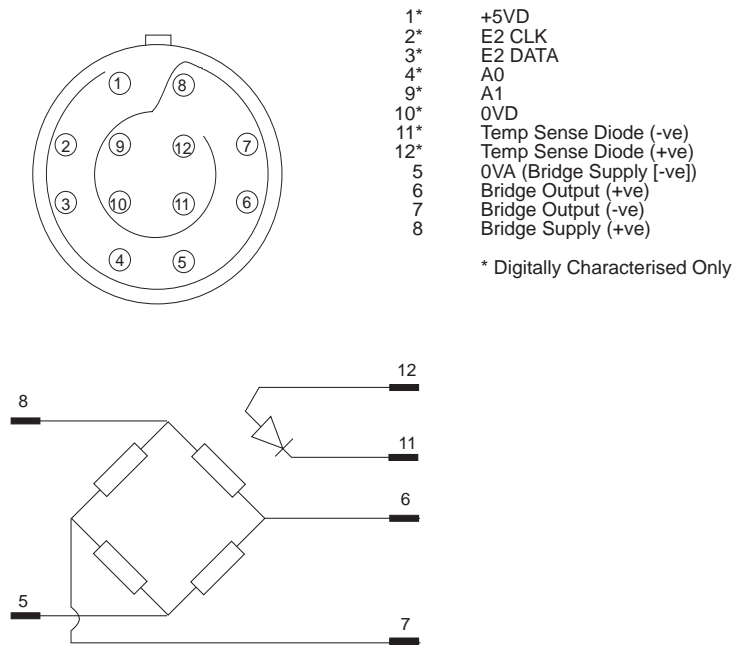

Figure 2.7 - External Transducer Connections

2.1.8 Digital Multimeter Connections

Connections to the Voltmeter/Milliammeter are made via the connector panel located on the left hand side of the instrument. Connections to the instrument are made by means of the supplied test leads (4mm plugs).

CAUTION: IF NOT MAKING USE OF THE TEST LEADS PROVIDED, USE LEADS TERMINATED WITH 4 MM SOCKETS FOR PLUGGING INTO THE INSTRUMENT. DO NOT PUSH BARE WIRES INTO THE SOCKETS.

Figure 2.8 shows the connector panel, located on the left hand side of the instrument and the connections for Voltage and Current Measurement.

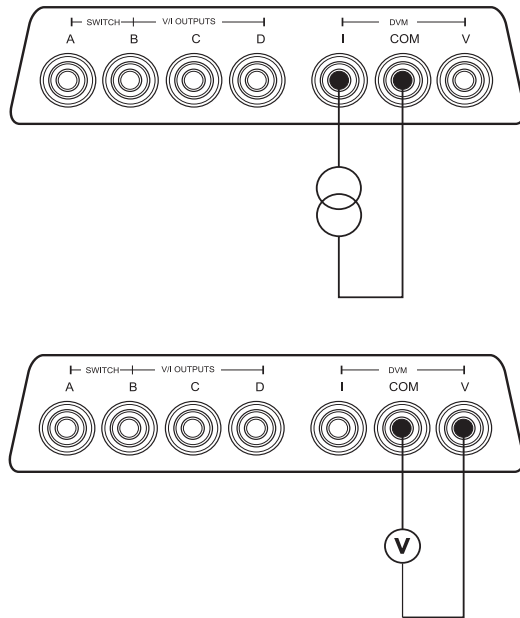

Figure 2.8 - Voltage and Current Measurement Connections

2.1.9 Electrical Input/Output Connections

Connections to the Switch Test, Data Log trigger and programmable output facilities of the instrument are made via the connector panel located on the left hand side of the instrument. Connections to the instrument are made by means of the supplied test leads (4mm plugs).

CAUTION: IF NOT MAKING USE OF THE TEST LEADS PROVIDED, USE LEAD TERMINATED WITH 4 MM SOCKETS FOR PLUGGING INTO THE INSTRUMENT. DO NOT PUSH BARE WIRES INTO THE SOCKETS.

Figure 2.9 shows the connector panel and the connections for Switch Test and Data Log Trigger inputs. Figure 2.10 shows the connections for the both the current and voltage outputs.

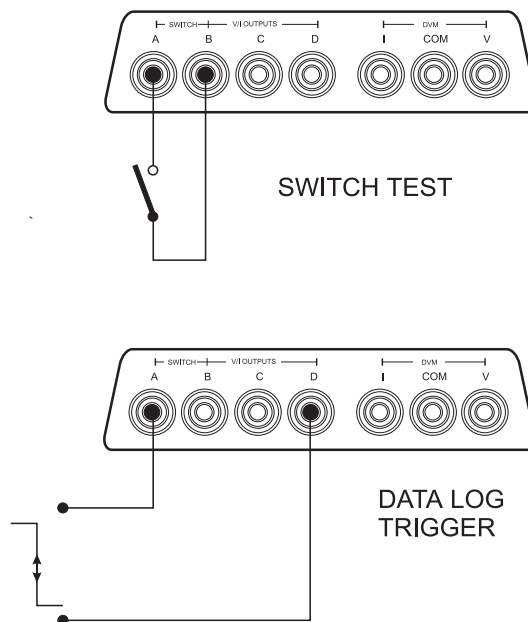

Figure 2.9 - Switch Test Data Log Trigger and Programmable Output Connections

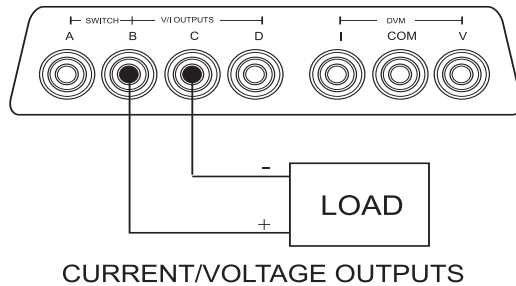

Figure 2-10 - Current/Voltage Output Connections

2.1.10 Temperature Probe Connections

The DPI 605 supports two types of Platinum Resistance Temperature Probes, a PT100 (for temperature ranges -55° to 200°C) and PT 25 (for temperature ranges -55° to 850°C). Temperature probes supplied with the equipment are terminated with an appropriate connector. The pin-out connections of the Temperature Probe are given in Figure 2.11.

To connect a temperature probe, plug the probe connector into the socket labelled **Temp Probe**, located on the right hand side connector panel.

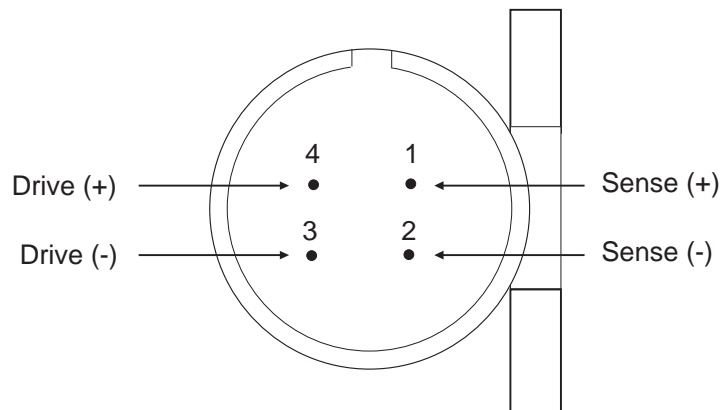

Figure 2.11 - Temperature Probe Connections

3 FAMILIARISATION

This chapter is designed to familiarise the first time user with the controls of the instrument. An overview of the functions of the display and controls is given in this section.

For the experienced operator, the operating procedures are described in Section 4.

3.1 Equipment Controls, Indicators and Connectors

Views of the instrument detailing the display and controls are shown in Fig. 3.1. These fall into three groups.

- Pressure source
- Input-output connectors
- Keyboard controls and display

The keyboard and display panel layout is shown below.

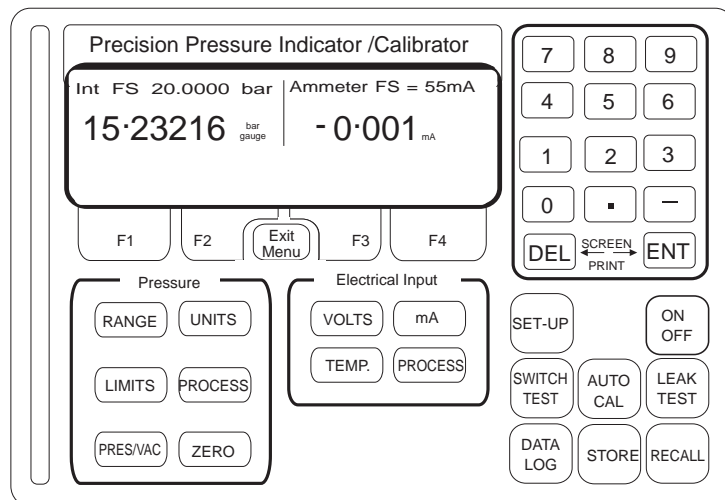

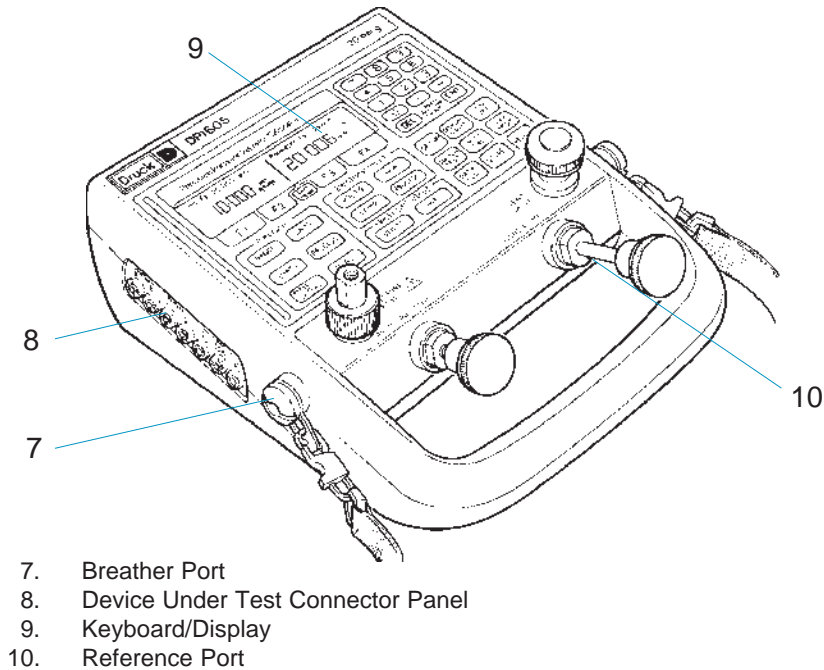
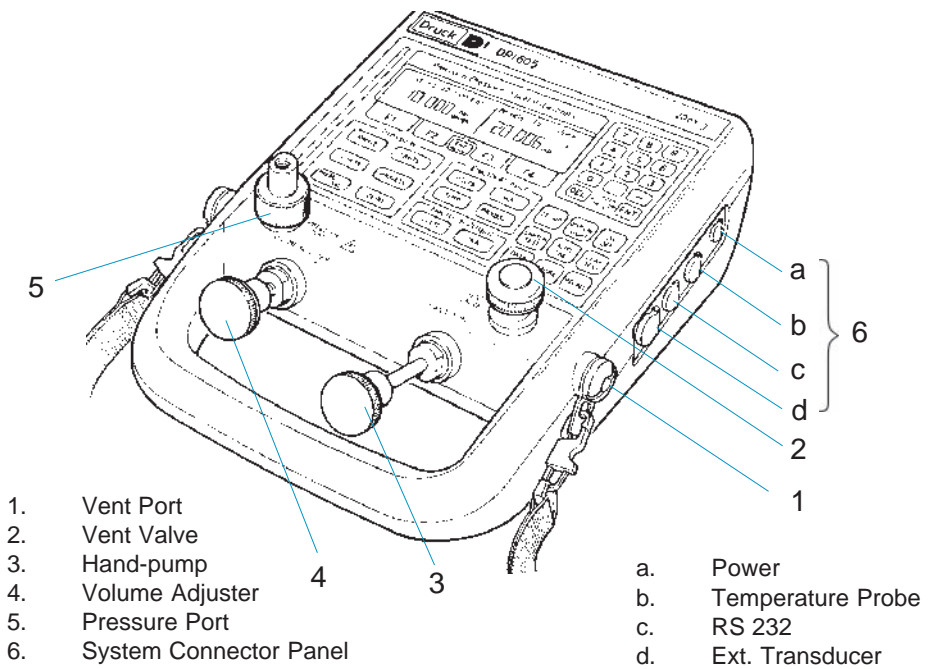

Figure 3.1 - DPI 605 Calibrator Controls and Connectors

3.2 Pneumatics - Calibrator (Fig. 3.1)

The DPI 605 pressure calibrator comprises the following items.

- **Hand-pump (3).**

After the Vent Valve (2) has been closed, this pump is used to create either a pressure or vacuum at the Pressure Port (5). Selection of pressure or vacuum is made from the Instrument Keyboard (9).

- **Volume Adjuster (4)**

Used to adjust the volume of the output manifold in order to provide fine adjustments of output pressure or vacuum level.

- **Pressure Port (5)**

Pressure connection to the device under test.

- **Vent Valve (2)**

Used to restore the output pressure/vacuum to atmospheric pressure. Clockwise rotation closes the valve, anti-clockwise rotation opens the valve.

- **Vent Port (1)**

System pressure vents via an aperture drilled through the centre of a strap Securing Boss (1).

- **Breather Port (7)**

Permits air to be drawn into, or exhausted from the hand-pump, depending upon whether the instrument is set to the pressure or vacuum mode.

- **Reference Port (10)**

The reference port for the internal sensors is located on the front face of the instrument case, below the pneumatics assembly. It contains a non-replaceable filter element.

If the instrument is fitted with the Barometric Reference option, it is pneumatically connected to this port.

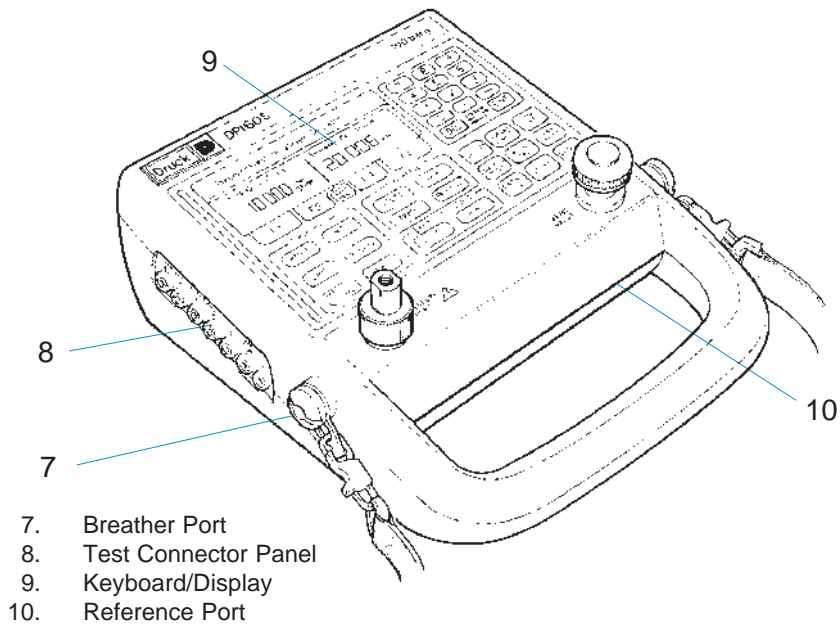
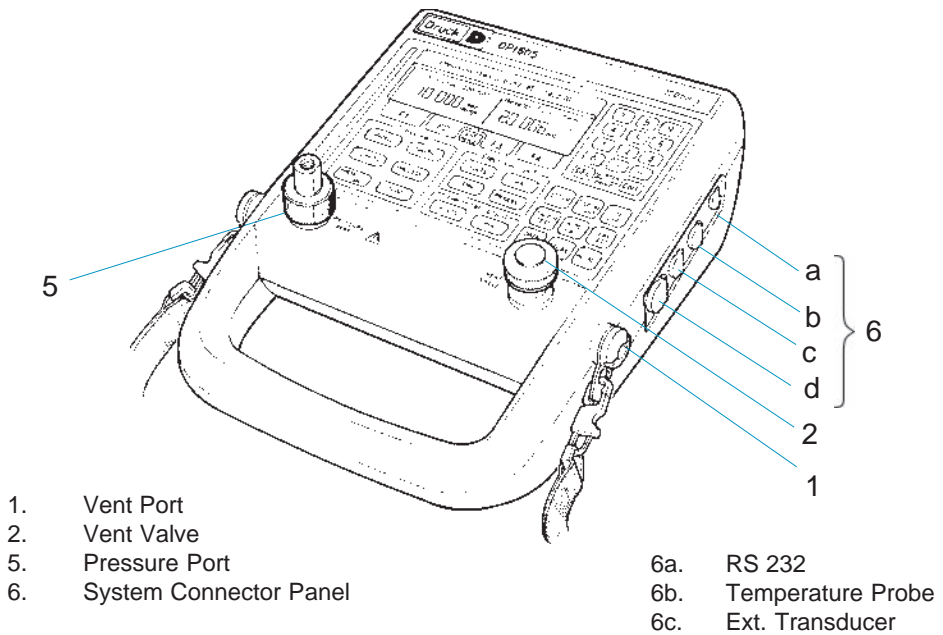

Figure 3.1a - DPI 605 Indicator Controls and Connectors

Pneumatics - Indicator (Fig. 3.1a)

The DPI 605 indicator pneumatics comprise the following items.

- **Pressure Port (5)**

Pressure connection to the device under test.

- **Vent Valve (2)**

Used to restore the output pressure/vacuum to atmospheric pressure. Clockwise rotation closes the valve, anti-clockwise rotation opens the valve.

- **Vent Port (1)**

System pressure vents via an aperture drilled through the centre of a strap Securing Boss (1).

- **Reference Port (10)**

The reference port for the internal sensors is located on the front face of the instrument case, below the pneumatics assembly. It contains a non-replaceable filter element.

If the instrument is fitted with the Barometric Reference option, it is pneumatically connected to this port.

3.3 Electrical Connections

All electrical connections to both the calibrator and indicator instruments are made via the panels (6) and (8) located on the sides of the instrument as shown in Fig. 3.1 and 3.1.a. The connections made via these panels are as follows.

● System Connector Panel

Located on the right hand side of the instrument item 6, (Fig. 3.1 and 3.1a). The connections made via this panel are shown below.

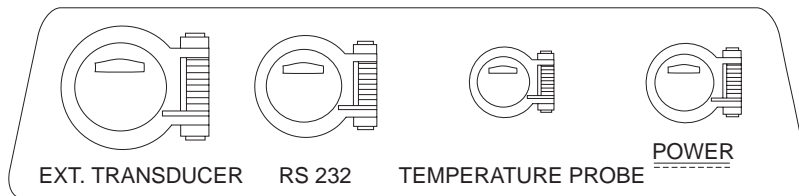

The sockets are allocated as follows.

- Mains adaptor/charger (POWER)
- Temperature probe (TEMPERATURE PROBE)
- RS 232 serial data interface (RS 232)
- External transducer (EXT. TRANSDUCER)

● Device Under Test Connector Panel

Located in the left hand side of the instrument, item 8 (Fig. 3.1 and 3.1a). The connections made via this panel are shown below.

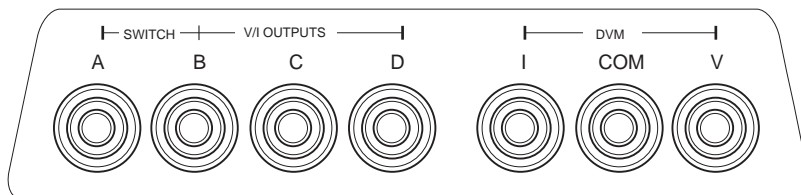

These sockets should be considered as two functional groups. Depending on the selected mode, the first group **A, B, C** and **D** provide either the programmable voltage/current outputs (**B-C & D**) switch test input (**A-B**), trigger signal input (**A-D**) or electrical output (**C-D**).

The second group, **I**, **COM** and **V**, provide the inputs to the instrument's built-in digital multimeter (DMM). Current inputs (up to a maximum of ± 55 mA d.c.), are applied between the common (COM) and I terminals. Voltage inputs (up to a maximum of ± 50 V d.c.), are applied between the (COM) and (V) terminals. The voltage function of the DMM is auto-ranging.

3.4 Display

Figure 3.2 shows the display and part of the keyboard of the DPI 605 instrument. Functionally, the display section is divided into two windows, one representing pressure measurements and the other electrical and temperature measurements.

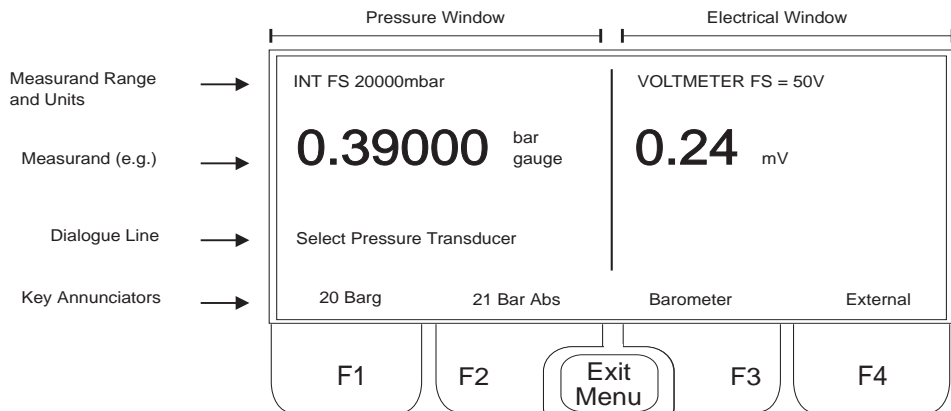

Figure 3.2 - DPI 605 Display

In the **Data Log** and AutoCal modes, the display is used to log data and provide a graphics function. For details of these formats, refer to the relevant mode description. Additionally, the display provides four status lines which indicate.

- **Measurand Range and Units**

Transducer selected (internal or external) for pressure window, DMM voltage, current or temperature.

- **Measurand**

Displays measured values and indicates any selected processing functions (e.g.) **Tare**, **Low Pass Filter**, **Flow** etc.

- **Dialogue Line**

Displays the currently selected operation and currently set value of any associated parameters.

- **Key Annunciators**

Displays the function allocated to the function keys (F1 to F4) located immediately below the display. The functions are software selected and will depend upon the currently selected mode of operation.

3.5 Keyboard

The keyboard of the DPI 605 is divided into six groups.

- Four function keys F1 to F4 and Exit Menu.
- Numeric keys.
- Pressure measurement keys.
- Electrical input keys.
- Electrical output keys.
- Mode select keys.

3.6 Function Keys

The calibration and measurement functions of the DPI 605 are menu driven by the instrument software and the user dialogue is via the four function keys, labelled F1, F2, F3 and F4. These function keys are allocated specific functions depending upon the particular mode of operation of the instrument which has been selected. The function allocated to each particular key is indicated by the Key Function Annunciator line of the display which writes a specific legend over the top of the key. The **Exit Menu** key is a special key whose function is not software allocated. An example of a typical function key allocation is shown below.

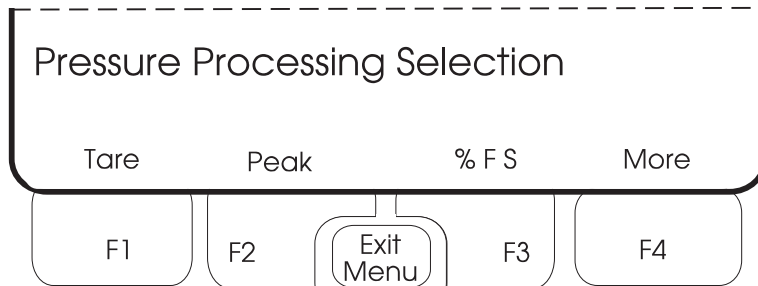

Figure 3.3 - Typical Function Key Allocation

In this example, which is displayed after operation of the **PROCESS** key, located in the pressure measurement group of keys, the primary functions allocated to the keys are as displayed in Fig. 3.3. These functions remain displayed for approximately 60 seconds and if no selection is made, the key allocations indicated are cancelled. The function keys are only active whilst the key allocation legend is visible. After this "time-out" period, the required mode must be re-selected in order to activate the function keys again.

The function keys are essentially the second level of a menu structure. Operation of a particular key takes the operator into the next level down, in which the functions of its F1 to F4 keys would be re-allocated. Selection of a third level function could perhaps move the operator down into a fourth level in which the function keys would again be re-allocated.

Operation of the **Exit Menu** key causes the system to move back up the menu structure to the level immediately above the current level or to clear the function key status line if it is already in the highest level.

3.7 Numeric Keys

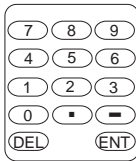

The numeric keys are used to enter numeric values.

Selected (positive and negative) values are accepted when the Enter (**ENT**) key is pressed. The Delete key (**DEL**) provides an edit function by deleting the last digit entered via the keyboard.

3.8 Pressure Key Functions

The pressure keys are used to select pressure measurement parameters.

- **Range**

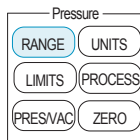

Used in conjunction with function keys F1 to F4 to select an internal or external pressure transducer and, if the barometric option is fitted, absolute, gauge or barometric pressure readings.

NOTE: The external and barometric options are not extended to the function keys unless the relevant sensors are fitted (or connected).

All pressure processing (e.g.) **Tare** is cancelled if a new range is selected.

- **Units**

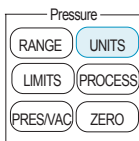

Used in conjunction with function keys F1 to F4 to select one of four pressure units for display. A choice of any one of 24 pressure units is assigned to the F1 - F4 function keys under **SET-UP** (refer to Section 3.11.3).

- **Limits**

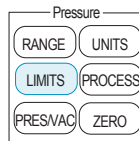

Used in conjunction with the F1 and F2 function keys and the numeric Key-pad, to define the **Alarm** and **Safety Limits** for the instrument. The maximum setting of the safety limit is 22 bar. The maximum setting of the alarm limit is 700 bar. The safety limit is always active but the alarm limit can be enabled and disabled. Crossing the

safety limit causes a pneumatic valve to close, blocking the pump action and thereby preventing further pressurisation. Pressing the **Exit Menu** key resets the safety limit.

- **Process**

The process key provides access to the following functions via the function keys.

- **Tare**

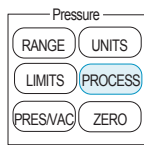

Provides facility to offset the displayed pressure reading by either the currently displayed pressure or a manually entered pressure value. This function can be enabled or disabled by the **On** (F3) or **Off** (F4) function keys.

A **T** symbol is displayed when the **Tare** function is enabled.

- **Peak**

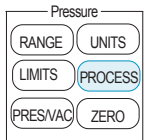

Enables display of maximum and minimum pressure levels obtained during operation. The function is enabled or disabled by the F3 and F4 keys respectively. The currently indicated levels are reset by the F1 key. The **Tare** function, if enabled, is active for all functions on the display, the **Tare** value therefore being subtracted from both the minimum and maximum readings as well as the pressure reading. This function is operative for reading in either pressure units or % F.S.

- **% FS**

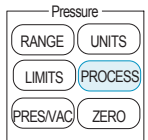

Converts the indicated pressure reading to a percentage of full scale (FS) reading over a user defined zero to full scale range.

- **Filter**

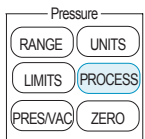

Provides a low pass filter function to stabilise the display if the instrument is connected to a 'noisy' (fluctuating) pressure line. This function can be enabled or disabled by the F1 and F2 function keys. A low pass filter symbol, \approx is displayed when this function is enabled.

3.8 Pressure Key Functions (Contd....)

○ Flow

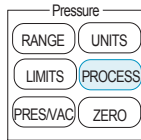

Converts the indicated pressure reading to a flow rate. Essentially a square root function. This function can be enabled or disabled by means of the F1 and F2 function keys. A square root symbol $\sqrt{\quad}$ is displayed when this function is enabled.

○ Pres/Vac

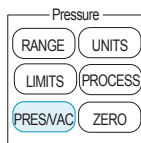

Changes the mode of the hand-pump from **pressure** generation to **vacuum** generation and vice versa. Change-over cannot occur whilst either a high pressure or vacuum state exists in the outlet manifold. If either of these conditions exist and change-over is required, the system must first be vented. If an attempt is made to switch the system to vacuum whilst the manifold is still pressurised or vice versa a message is displayed (e.g.) **Please Vent the System.**

○ Zero

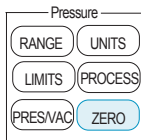

Used to provide a zero offset function for the pressure display. This control cannot be used to remove very large offsets. These should be removed by the **Tare** function.

3.9 Electrical Input Key Functions

The four electrical input controls located in this Key-pad area are used to control the mode of operation of the digital multimeter (DMM) section of the instrument. The key functions are as follows.

● Volts

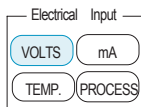

Selects voltmeter to be displayed in the electrical window of display. Voltage input signals are applied between the **V(+)** and **COM(-)** terminals. The maximum voltage that can be measured is ± 50 V d.c. and the voltage function is auto-ranging. The maximum range value is displayed on the instrument when this mode is selected (e.g.) **Voltmeter FS = 50 V.**

All electrical processing (e.g.) **Tare** is cancelled if a new measurand for the electrical display window is selected.

- **mA**

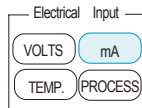

Selects milli-ammeter to be displayed in the electrical window of the display. Current input signals are applied between the **I (+)** and **COM (-)** terminals. The current range is $\pm 55\text{mA}$ maximum. The maximum range value is displayed on the instrument when this mode is selected.

All electrical processing (e.g.) **Tare** is cancelled if a new measurand for the electrical display window is selected.

- **Temp.**

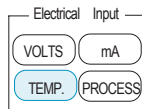

Used in conjunction with either an external (optional) PT100 or PT25 platinum resistance probe to read temperature. Units of temperature are selectable ($^{\circ}\text{F}$ or $^{\circ}\text{C}$) under the **SET-UP** (Default Units) facility (refer to Section 3.11.3, Page 3-21). The display echoes the type of **Temperature Probe** currently selected. Selection of **Temperature Probe** type is carried out under the **Temp. Probe** option (Section 3.11.3, Page 3-25).

All electrical processing (e.g.) **Tare** is cancelled if a new measurand for the electrical display window is selected.

- **Process**

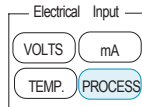

The electrical process key provides access to the following functions for all three (**Voltage**, **Current** and **Temperature**) measurands.

- **Tare**

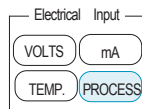

Provides the facility to offset the displayed parameter either by the currently displayed value (**Reading**) or a manually entered value (**Manual**). The function is enabled or disabled by the **On** (F3) and **Off** (F4) function keys respectively. A **T** symbol is displayed when the **Tare** function is enabled.

3.9 Electrical Input Key Functions (Contd....)

○ Peak

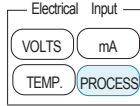

Enables display to show maximum and minimum parameter levels obtained during operation. When selected, the function is enabled or disabled by means of the **On** (F3) and **Off** (F4) function keys respectively. The currently displayed maximum and minimum levels are reset by the F1 key. The **Tare** function, if enabled, is active for all functions on the display, the **Tare** value therefore being subtracted from both the minimum and maximum reading as well as the electrical reading.

○ % FS

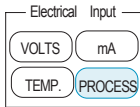

Converts the indicated parameter reading to a percentage of full scale (F.S.) reading over a user defined zero to full scale range. The zero and full scale points can be set either by direct numerical entry via the numeric key-pad, or, by means of function key F1, accepted as the currently displayed reading. The function is enabled or disabled by the **On** (F1) and **Off** (F2) function keys respectively.

○ Filter

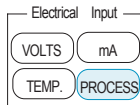

Provides a low pass filter to stabilise the display reading if the instrument is connected to a noisy (fluctuating) input signal line. This can be enabled or disabled by means of the **On** (F1) and **Off** (F2) function keys. A low pass filter symbol is displayed \approx when this function is enabled.

○ Flow

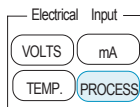

This is essentially a square root function. This function is programmable ON/OFF by means of the **On** (F1) and **Off** (F2) function keys respectively. A $\sqrt{\quad}$ symbol is displayed when this function is selected.

○ Deviation

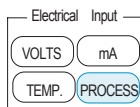

Used to display signal deviation. On selection, a choice of **Accept**, **Format** or **Off** is given from the F2, F3 and F4 function keys respectively.

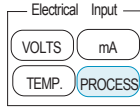
**Accept (F2)**

Permits a straight line to be defined by a full scale and a lower point, by direct entry of data from the numeric Key-pad. The form of entry is pressure units (as currently selected in pressure display), referenced to a parameter (e.g.) voltage level (for both full scale and lower limits). The **Accept** switch toggles between full scale and lower limit entry lines.

Format (F3)

Used to select the error format of the displayed error. Available options are either percentage of full scale (**%FS**), percentage of reading (**%RDG**) or in the currently selected electrical units (**E-Units**) or pressure (**P-Units**).

OFF (F4)

Turns the deviation function OFF.

- **Zero**

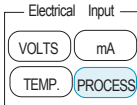

Used to cancel any zero offset on the recorded display level when either **mA** or **Volts** is selected.

3.10 Electrical Output Key Functions

The two electrical output selector keys are used to configure the electrical outputs as either a fixed voltage or current, programmable via the Key-pad or an “analogue output” - voltage or current proportional to any measurand (i.e.) pressure, voltage, current or temperature. When configured, the electrical outputs are taken from the **B**, **C** and **D** sockets, located on the left hand side of the instrument (refer to figure 3.1).

- **Volts**

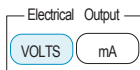

This key configures the instrument to provide an output voltage. The output voltage range is programmable by the user within the range 0 to 24 V and can be configured as either an analogue output, proportional to any instrument measurand (e.g.) pressure, temperature or as a programmable voltage level.

- **mA**

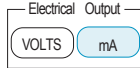

This key configures the instrument to source a current output. The output current range is programmable by the user within the range 0 to 55mA, and can be configured as either an analogue output, proportional to any instrument measurand (e.g.) pressure, temperature or as a programmable single current level.

Selection of either **VOLTS** or **mA** provides the user with a sub-menu which allows the output level to be configured as either an **Analogue Output**, proportional to a measurand, or a **Programmable Output** (single voltage or current within the range 0 to 24V or 0 to 55 mA). The options are as follows.

- **Analogue Output**

This option is used to select the source measurand for the analogue output, either **Pressure** or **Electrical**.

- **Pressure**

Selection of the pressure option provides three system facilities - **Set-up**, **On** and **Off**. **Set-up** is used to specify the required linear relationship between the measurand (Pressure) and the selected type of analogue output, (Voltage or Current).

- **Set-up**

When the **Set-up** key is pressed, a prompt is displayed for entry of a lower point (e.g.).

lower point : 0.00000 bar = 0.0000V

Enter the desired measurand lower point and press **ENT** and then the required corresponding lower output level and press **ENT** again. Accept the entered parameters by pressing the **Accept** key and a prompt will be given for an Upper point (e.g.).

upper point : 15.00000 bar = 20.0000V

Enter the desired measurand upper point, and press **ENT**, followed by the corresponding upper output level and press **ENT** again.

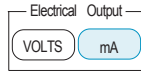

Having set the required relationship, press the **Exit Menu** key to return to the **Set-up** menu. The **On** (F3) and **Off** (F4) keys are used to enable or disable the output as follows.

■ On

Switches the electrical output ON. The electrical window of the display now divides into two sub-sections to give the currently selected DMM display in the upper section and the electrical output conversion status (e.g.) **Pressure to Voltage** in the lower section. It should be noted that when the electrical output is enabled, the output power is sourced from the instrument's internal battery and will therefore increase the battery's rate of discharge.

■ Off

Switches the electrical output to OFF. When the instrument is powered up, the electrical output will always be switched off (i.e.) if it was enabled when the instrument was turned off, it will need to be re-enabled after switch on.

Electrical

Selection of the Electrical option provides three system facilities - **Set-up**, **On** and **Off**. **Set-up** is used to specify the required linear relationship between any of the electrical measurands (Voltage, Current, or Temperature) and the selected type of electrical output, (Voltage or Current).

■ Set-up

When the **Set-up** key is pressed, a prompt is displayed for entry of a lower point (e.g.).

lower point : 000.00 oC = 0.0000 mA

Enter the desired measurand lower point on the numeric keypad and press **ENT** and then the required corresponding lower output level and press **ENT** again.

3.10 Electrical Output Key Functions (Contd...)

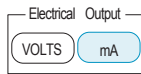

Accept the entered parameters by pressing the **Accept** key and a prompt will be given for an Upper point (e.g.).

upper point : 150.00 °C = 15.0000 mA

Enter the desired measurand upper point, and press **ENT**, followed by the corresponding upper output level and press **ENT** again.

Having set the required relationship, press the **Exit Menu** key to return to the *Set-up* menu. The **On** (F3) and **Off** (F4) keys are used to enable or disable the output as follows.

■ On

Switches the electrical output ON. The electrical window of the display now divides into two sub-sections to give the currently selected DMM display in the upper section, and the electrical output conversion status (e.g.) **Temperature to Current** in the lower section. It should be noted that when the electrical output is enabled, the output power is sourced from the instrument's internal battery and will therefore increase the battery's rate of discharge.

■ Off

Switches the electrical output to OFF. The lower section of the electrical display (the electrical output section) will indicate OFF when this control has been operated. When the instrument is powered up, the electrical output will always be switched off (i.e.) if it was enabled when the instrument was turned off, it will need to be re-enabled after switch on.

- **Programmable Output**

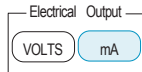

This option of the **Electrical Output** function menu is used to select the output of either a programmable d.c. voltage or current. Typical uses of this facility are as an excitation supply for a transducer, 20 mA current loop (source or sink) and as a precision reference supply. Used as a voltage source, the instrument can supply a maximum current of 50 mA at 24 V. When used as a current source, the instrument can provide up to 55 mA current drive from a 19 V source. As a current sink, the instrument will provide a controlled output, within the range 0 to 55 mA, from a 30 V source. To use the instrument as a voltage or current source, the **B (+ve)** and **C (-ve)** terminals are used. To use the instrument as a current sink, the **C (+ve)** and **D (-ve)** output terminals are used.

Following selection of either **Volts** or **mA** from the Electrical Output keys, selection of the **Prog Output** option provides a sub-menu offering three system facilities, **Set**, **On** and **Off**.

- **Set**

When the **Set** key (F1) is pressed, the last programmed output level will be displayed, together with **Up** (F1) and **Down** (F2) options. A typical display is shown below.

Voltage output setting: 5.000V

Use a combination of the **Up** and **Down** keys to set the required output level or, alternatively, enter the output level directly from the keyboard, followed by **ENT**. When the correct output has been set, press the **Exit Menu** key and enable the output level by pressing the **On** key.

Note that if a different electrical output function (e.g.) **mA** is subsequently selected, the output is switched OFF and the **Set** prompt for the newly selected parameter is displayed.

To disable the output press the **Off** key (F4).

3.11 Mode Select Keys - (Blue Keys)

There are nine mode select keys, the functions of which are as follows.

3.11.1 On/Off

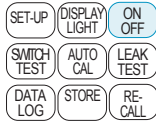

This toggle action key is used to switch the instrument ON or OFF. The instrument can be programmed to switch itself off after a defined period of inactivity i.e. no key presses, by means of the set-up facility. It should be noted that during Data Logging and Leak Testing, the Auto Power-off facility is disabled. The default setting for the Auto Power-off facility is 30 min.

3.11.2 Display Light

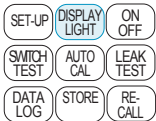

This toggle action key is used to switch the display panel back-light ON and OFF.

The instrument can be programmed to turn the back-light off after a defined period under the set-up facility. The default setting is 5 sec. Prolonged use of the back-light will reduce battery life.

3.11.3 Set-up

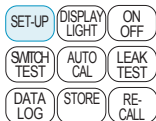

Used to set-up the instrument **default settings**, **battery**, **status** and **cal/test** and functions.

- **Defaults**

This function is used to set-up the following functions.

- **Units**

Function used to select default units for the Pressure and Temperature measurands.

■ Pressure

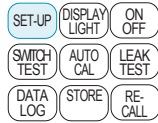

Used to select the pressure units assigned to function keys F1, F2, F3 and F4 (See **Units - Pressure Key-pad**, Section 3.8). Operation of this key displays the full range of units available, together with an indication of the units to which each function key is currently assigned.

bar	kg/m2	torr	ftH2O
Pa - F4	mmHg - F3	atm	ftH2O4
hPa	cmHg	psi - F2	Spec'l
kPa	mHg	lb/ft2	Blank
MPa	mmH2O	inHg	Blank
mbar - F1	cmH2O	inH2O	Blank
kg/cm2	mH2O	inH2O4	

The default setting for any key is changed by pressing the required function key which will cause it to scroll through the menu, missing out units assigned to the other function keys. The key is assigned the unit beside which it is displayed. Assigning three function keys to **Blank** provides the facility of setting-up the instrument for single pressure unit operation.

■ Spec'l

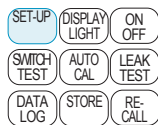

This option is used to set-up any special conversion factors required for the pressure units. The conversion factor (Pascals to Special Units) is entered from the numeric key-pad.

■ Temperature

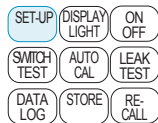

This function is used to set the display to read either degrees **Fahrenheit** (°F) or degrees **Celsius** (°C).

3.11.3 Set-up (Contd....)

○ Comms

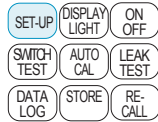

This function is used to set-up the RS 232 communications parameters.

Selecting Comms from the Default menu set-up provides the facility to set-up the **Baud-rate** (F1), **Parity** (F2) and **Handshake** (F3) parameters for the RS 232 communication protocol.

■ Baud-rate

This option allows the baud-rate to be set-up via the **Previous** (F1) and **Next** (F2) keys. The current setting is indicated by an arrow. A typical Baud-rate display is shown below.

Select baud-rate

110	600	150
1200	300	2400 ←
4800	9600	19.2K
Previous	Next	

After setting up the required baud-rate, press **Exit Menu** to return to the Comms sub-menu.

■ Parity

This option allows the RS 232 parity checking to be set-up. Three options are available **Odd** (F1), **Even** (F2) and **None** (F3).

■ Handshake

Selection of this option allows the RS 232 handshaking mode to be set-up. Four options are available, **None** (F1), **Software** (F2), **Hardware** (F3) and **Both** (F4).

3.11.3 Set-up (Contd....)

- **Clock**

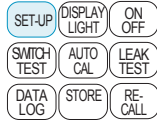

The clock facility permits the operator to set-up the instrument's clock and calendar functions. Two sub-functions, **Time** and **Date** are provided, each of which permit entry of a new system parameter i.e. **Time** or **Date**.

- **Printer**

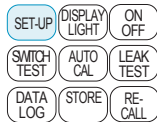

This facility offers a choice of printer which is selected from the printer set-up menu.

Selecting the **Printer** option from the Default menu, provides a list of printers supported by the instrument (e.g.),

Printer Selection

Druck 40 column printer ←
80 column printer

Previous Next

The currently selected printer is indicated by the position of the cursor arrow. Use the **Previous** (F1) and **Next** (F2) keys to move the cursor arrow to select the required printer.

Press the **Exit Menu** key to return to the Default Settings menu.

- **Contrast**

This facility is selected by **Defaults** (F3) from the Set-up menu. It is used to select the contrast of the display and provides an adjustment over the range 0 (Light) to 100% (Dark). After selection, the display indicates the current contrast level (e.g.) 50% as follows.

Adjust contrast 50%

Up Down

Select the required level by using the **Up** (F1) or **Down** (F2) keys. Press **Exit Menu** to return to the Set-up menu or allow the function to time-out.

3.11.3 Set-up (Contd....)

- **Auto-Off**

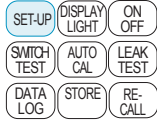

The functions available in this category allow the auto-off features of the instrument to be set-up. There are two options available, **Power** and **Light**.

- **Power**

Provides an option to select a power saving function for the instrument by providing a facility to allow an automatic turn off after a preset (keyboard entered) period of inactivity i.e. no key-presses. This facility is enabled by the **Enable** (F3) option and disabled by the **Disable** (F4) option.

The default setting gives a period of 30 min. When one minute of the time out period remains, the instrument produces short bleeps to warn the operator. Pressing any key will reset the timer.

- **Light**

Provides a power saving option to turn off the back-light (after switch on), by providing a facility to automatically switch it off after a preset (keyboard selected) period. This facility is enabled by the **Enable** (F3) option and disabled by the **Disable** (F4) option. The default setting gives a period of 5 seconds.

- **Resolution**

Used to select the number of significant figures displayed after the decimal point. Can be set to provide a range of up to 6½ digits depending upon the type of units selected, and is applicable to the pressure reading only.

- **On State**

This feature provides the operator with the option of having the instrument to power up either in its last set-up state (as it was switched off) or in the standard default state. In the latter state, programmed processes (e.g.) **Tare** and **Filter** would be automatically switched off when the instrument is switched off and any programmed outputs would be disabled.

3.11.3 Set-up (Contd....)

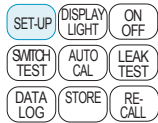

If the instrument is programmed to 'Restore Last Set-up' all enabled features would remain as set except the programmable outputs would become disabled even if they were enabled at 'switch off'.

- **Temperature Probe**

This feature is used to set the instrument to accept its temperature input from either a PT100 or PT25 Platinum resistance probe. The PT100 probe covers the temperature range -55° to 200°C and the PT25 probe -55° to 850°C.

- **Filter**

This feature is used to set up the characteristics of a low pass digital filter which can be applied to both the pressure and electrical measurands. Selection of **Filter** from the Setup menu provides a choice of **Pressure** or **Electrical**. Selection of either of these two options shows the current status of the filter parameters for that measurand and provides a facility to change them (e.g.),

Average ■3.0 Step 0.05 %

Average sets the damping factor (time constant) of the filter and **Step**, the response to a step increase in the measurand. In the above example, a step increase greater than 0.05% would be ignored by the filter and the new value acquired immediately. The default settings are **3** (max 100) and **0.05%** (max 100%). The pressure and electrical filter characteristics can be different for each measurand.

- **Battery**

The battery function provides a status report on the battery's state of charge. When the function is selected, the battery voltage is indicated, together with a status statement (e.g.),

Battery = 9.37 V Good

Three status statements are provided, *Good*, *Okay* and *Poor*. When the *Poor* status is indicated, the battery should be recharged or, if alkaline cells are fitted, replaced.

3.11.3 Set-up (Contd....)

- **Status**

The Status facility provides details of the instrument's internal and external pressure calibration dates together with electrical calibration details. Selection of the function causes the Ratio Calibration Dates to be displayed as follows (e.g.),

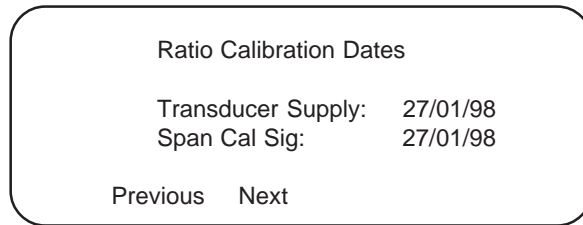

Operation of the **Next** (F2) Key, causes successive sets of calibration data to be displayed in turn. The data displayed is as follows.

<p>Ratio Calibration Dates</p> <p>Electrical Calibration Dates</p> <p>Barometer Calibration Dates</p> <p>Internal Range 1 Calibration</p>	<p>Internal Range 2 Calibration</p> <p>External Range 1 Calibration</p> <p>External Ranges 2 to 10</p>
---	---

To exit the function, press **Exit Menu**.

- **Cal/Test**

This facility provides access to the instrument's calibration and self test facilities. It requires the entry of a password (PIN number) before entry is permitted. Details of the use of this facility are provided in the calibration procedures (Section 6). When the instrument is first supplied, the allocated PIN number is 123. The calibration facility should be used with extreme caution - **Misuse of this facility can cause loss of the instrument's calibration.**

- **Keyboard Locking Facility**

This feature will allow any of the keyboards keys, with the exception of the **ON/OFF** key to be either enabled or disabled. The instrument is supplied with all keys enabled. Under Cal/Test, the keyboard locking facility is password protected.

3.11.3 Set-up (Contd....)

This feature will allow any of the keyboard keys, with the exception of the **On/Off** key to be either enabled or disabled. To change the status of any keys from unlocked to locked and vice versa, proceed as follows.

SET UP	
○	Defaults
○	Battery
○	Status
●	Cal/Test
<hr/>	
<input type="checkbox"/>	Cal
<input type="checkbox"/>	Test
<input type="checkbox"/>	New Pin
<input checked="" type="checkbox"/>	Keyboard

- Switch the instrument ON.
- Press the SETUP key and select **Cal/Test** and enter the PIN number.
- Select Keyboard from the Cal/Test menu. A complete listing of the keys is now written to the display, together with the current status of each key (e.g.).

RANGE	ON	SWITCH	ON	PRESS/VAC	ON
UNITS	ON	AUTOCAL	ON	VOLTS	ON
LIMITS	ON	LEAK	ON	mA	ON
P PROC	ON	DATA LOG	ON	TEMP	ON
ZERO	ON	STORE	ON	VOLTS O/P	ON
E PROC	ON	RECALL	ON	mA O/P	ON
PRINT	ON	SETUP	ON	LIGHT	ON
Up	Down	On	Off		

Initially, the cursor will be positioned over the **Range** key (flashing over the first character of the status indication).

- Use the **Up** (F1) and **Down** (F2) keys to position the cursor over the desired key and then use the **On** (F3) or **Off** (F4) keys respectively to enable or disable that particular key.
- To exit the Key Locking facility, press **Exit Menu** twice.

3.11.4 Switch Test

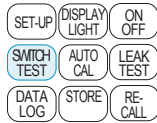

This function configures the instrument to test pressure operated switches. When the function is selected and a pressure switch is connected to the instrument, the pressure display indicates the applied pressure and the status of the pressure switch contacts (e.g.) **contacts closed**. When the output pressure is subsequently increased (decreased) and the switch contacts change state, the display records the event (e.g.),

Switch contacts opened at 5 bar.

3.11.5 Data Log

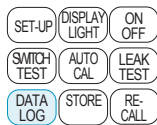

This function configures the instrument to act as a Data Logger and store a large number of complete screen displays. The Data Log option provides two basic options **Record** and **Replay**. In addition, two Data Log utility options are provided, **Directory** and **Delete**. When the Data Log function has been selected, the function keys F1 to F4 are allocated to the **Record**, **Replay**, **Directory** and **Delete** functions respectively. This section provides a basic overview of the options. Details of the operation of the Data Log facility are given in Section 4.14.

3.11.5 Data Log (Contd....)

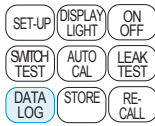

Data entry is made via the numeric key-pad followed by **ENT**. Leading zeros need not be entered.

Following entry of the sampling period, the stop event must be defined. A choice of two options is provided **Stop Time** (F1) and **Samples** (F2).

▣ Stop Time

When the **Stop Time** option is selected, the instrument prompts for the entry of a time (e.g.)

Stop Time (Hrs. Mins.) ▣

The time is entered via the numeric key-pad, followed by **ENT**. The instrument now prompts for a Data Log Start condition to be defined (e.g.)

Timed Data Log Start

Now	Later	Condition
-----	-------	-----------

By selection of one of these functions the Data Logging operation will commence either immediately (**Now**), at a later time (**Later**) or following one of a number of external event options (**Condition**). These options are **Switch**, **Logic** and **Threshold**. Section 4.14 fully describes these features.

When all the Data Log parameters have been defined, a summary screen is written to the display as follows (e.g.),

Data Log Parameters		Logging Trigger	
Start:-	Threshold 15.0000 bar	Log on:-	Periodic time 00.00.05
Stop:	20 Samples		
File ID	B1601		
Continue			Quit

This summary screen which is presented as soon as all the Data Log parameters have been defined, remains displayed until the **Continue** (F1) key is pressed. Following this, the Data Log function is enabled.

■ Samples

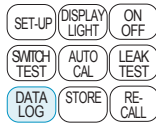

If number of samples is selected as the Data Log Stop condition, the instrument prompts for the entry of a number of Samples (e.g.).

Enter number of Samples ■

Following entry of the required number of samples on the numeric keypad, the instrument prompts for a Data Log Start condition to be defined (e.g.)

Time Data Log Start Now Later Condition

By selection of one of these functions (**Stop Time** or **Samples**), the Data Logging operation will commence either immediately (**Now**), at a later time (**Later**) or following one of a number of external event options (**Condition**). These options are **Switch**, **Logic** and **Threshold**. Section 4.14 fully describes these features.

When all the Data Log parameters for this option have been defined, a summary screen will be presented (e.g.),

Data Log Parameters		Logging Trigger	
Start:-	Logic Test -ve edge	Log on:-	Periodic time 00.00.30
Stop:	50 Samples		
File ID	AZ376		
Continue			Quit

■ Event

The **Event** mode enables the Data Logger to be triggered by external events. Three event options are available, **Now**, **Later** and **Condition**.

The **Now** option provides the operator with the facility to manually trigger a log operation each time the **Log** (F1) key is pressed. The mode is exited by pressing the **Stop** (F4) key.

The **Later** Option permits a future start time to be entered to perform a 'single shot' logging operation at a pre-programmed time.

3.11.5 Data Log (Contd....)

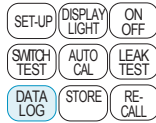

The external (**Condition**) switching options available under the Event Logger mode are either **Switch**, **Logic** or **Threshold**.

■ Switch

The Event **Switch** option is used to select the operation of an external switch, connected between the A-B terminals, to trigger the Data Log operation. A choice of normally closed (**Wait Switch Closed**) or normally open (**Wait Switch Open**) is provided. In either of the Switch modes, the selected Log operation is initiated every time the switch contacts change state.

The Data Logging operation is then manually terminated when the **Stop** (F4) key is pressed.

■ Logic

The **Logic** option is used to trigger the selected Data Logging operation on receipt of a trigger pulse, level 5 to 30 V d.c., which is applied between the **A(+)** and **B (-)** or **D (-)** terminals of the instrument. A choice of either positive or negative logic (positive going or negative going pulse) is provided. The Data Logging operation is then manually terminated when the **Stop** (F4) key is pressed.

■ Threshold

The **Threshold** option is used to initiate a one-shot Data Log sequence when either the pressure measurement or the selected electrical input volts, mA or Temp. measurement passes a preset (operator programmable level). For each type of measurand, the direction through the preset threshold either positive or negative, i.e. rising or falling, can be selected. The Data Logging operation then terminates when the **Stop** (F4) key is pressed.

When all the required Event Data Log parameters have been defined, a summary screen written for the display (e.g.),

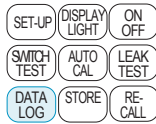

Data Log Parameters	Logging Trigger
Start:- N/A	Log on:- + Threshold 12.5000 bar
Stop: Single Shot	
File ID: E1220	
Continue	Quit

The screen remains displayed until either **Continue** (F1) or **Quit** (F2) is pressed. Following selection of **Continue** (F1) the selected **Event** Data Log function is enabled.

- **Replay**

The **Replay** option (F2) is used to either recall any selected Data Log file to the display or to download the stored data to an external printer via the RS 232 port.

When **Replay** is selected, a directory, showing the first page of Data Logged files is displayed. To replay a Data Log file, select the desired file by means of the **Page Up** (F1), **Page Down** (F2), **↑** (F3) or **↓** (F4) cursor keys and press the **ENT** key on the numeric key-pad.

Four display modes are then provided, these being termed **Display** (F1), **Graph** (F2), **Printer** (F3) and **Upload** (F4).

- **Display**

When the **Display** option (F1) is selected, the data contained in the first location of the file is recalled to the display. Data in each sequential location can then be recalled by operation of the **Next** key (to go forward) or the **Previous** key (to go back). The end of file is indicated by the message **End**.

To exit Display mode, press the **Exit Menu** key.

3.11.5 Data Log (Contd....)

- Graph

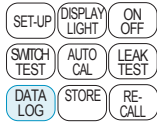

The **Graph** option is used to provide a graphical indication of a selected Data Log file. Three options are provided **PvT** (Pressure v Time), **EvT** (Electrical v Time) and **PvE** (Pressure v Electrical). A typical display is shown below.

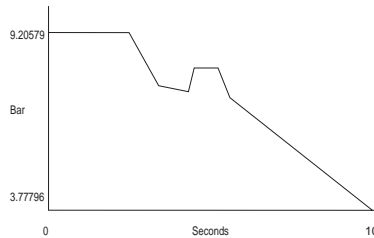

To exit Graph Mode, press the **Exit Menu** key.

- Print

Selection of the **Print** option enables all data associated with the selected replay file to be downloaded to a printer. To make use of this option, a printer must be connected to the RS 232 interface. The appropriate printer must also have been selected from the Set-up Menu. Refer to Section 3.11.3 (Printer).

- Upload

This option is used to transmit (**Upload**) Data Log data to an external system via the RS 232 port. Note that the RS 232 port must be configured in the correct way for the external system. RS 232 configuration is carried out under the **Set-up** option (**Comms**).

- Directory

The **Directory** option provides a list of all the completed Data Log operations that have been stored in the instruments memory. These will be listed in the order in which the Data Log operations were carried out (not in file ID number order). A typical directory listing is shown below.

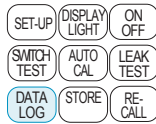

File ID (Data Log)		Free Blocks: 10846
A17966	28/01/93	15.37.10
A17222	28/01/93	15.40.03
C22713	28/01/93	15.51.32
C070842	28/01/93	15.51.32
B2	28/01/93	15.58.17
Page Up		Page Down

The (e.g.) **Free Blocks: 10846** legend gives an indication of remaining memory space and the first five entries in the directory are displayed. The **Page Up** and **Page Down** functions, allocated to the F1 and F2 keys respectively, provide a means of scrolling forward (to the next page) or back (to a previous page) of a directory listing. The **Exit Menu** key is used to return to the main Data Log menu. When first entering the **Data Log** functions, it is good practice to interrogate the directory. This will enable the operator to determine what file ID numbers have already been used, since an attempt to use an existing file ID number to record on an operation will result in the display of an error message - **File already exists**.

- Memory Space

On many **Data Log** and **AutoCal** screens, a message (e.g.) "**free blocks: 9198**" appears. This gives an indication of the amount of memory, in blocks, that is available for use.

When a screen of data is recorded, one block is used for storing the time and date, and one block for each measurand on the screen. For example, if the instrument was simply measuring pressure and voltage, then to store one screen would take three blocks of memory. However, if the programmable output was on and also the peak function was enabled, then six blocks would be used to store one screen, one for each of the following.

- Time and date
- Voltage measurement
- Programmable output value
- Pressure Measurement
- Peak high
- Peak low

3.11.5 Data Log (Contd....)

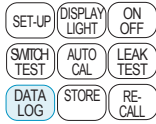

When the instrument is used to replay a Data Log or AutoCal file, a 'temporary file' is created which is invisible to the user. If there is not enough free memory space available, a temporary file as large as possible is created. Under these circumstances, only the part of the replay file accommodated in the temporary file will be available for replaying. If more space is made by deleting other files, then replay of the whole file will subsequently be possible.

NOTE: If the file is extracted from the instrument via the RS 232 interface using the SCPI protocol, the whole file is always retrieved.

- **Delete**

This Data Log function enables files to be deleted from the Data Log memory. Selection of the function provides a directory listing and four cursor keys **Page Up** (F1), **Page Down** (F2), **↑** (F3) and **↓** (F4) (e.g.)

File ID (Data Log)	Free Blocks: 10846	
→ A	28/01/93	15.37.10
B	28/01/93	15.40.30
C	28/01/93	15.43.16
D	28/01/93	15.49.32
E	28/01/93	15.58.29
Page Up	Page Down	↑ ↓

The **Page Up** and **Page Down** keys are used to select the appropriate directory page and the **↑** **↓** keys to select the file on the page. To delete the selected file, position the cursor against the file name and press the **ENT** key on the numeric key-pad. A warning is displayed as follows.

Delete - Are you sure?
Yes **No**

The file is deleted on subsequent operation of the **Yes** (F3) key or the Delete operation aborted by operation of the **No** (F4) key.

3.11.6 Leak Test

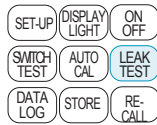

This function provides a leak test facility for the unit (system) under test. When the facility is selected, the electrical window of the display is re-configured to indicate **Pressure Drop** and **Leak Rate**. Four sub-functions are allocated to the facility as follows.

- **Wait**

Permits the entry of a delay period between operation of the **Start** function and commencement of the test period.

- **Time**

Sets the duration of the leak test period.

- **Start**

Initiates a leak test.

- **Reset**

Clears leak test display values after the completion of a test.

For full details of how to conduct a leak test, refer to Section 4.8.

3.11.7 Store



This function permits the current display (pressure and electrical windows) to be stored in one of twenty memory locations.

Operation of the **STORE** Key initially provides the facility to add alpha numeric characters to the stored display. Alpha characters are entered by means of the **Alpha ↑** (F1), **Alpha ↓** (F2), **←** (F3) and **→** (F4) keys. **Alpha ↑** (F1) scrolls forwards through the alphabet and **Alpha ↓** (F2) backwards. Shifting right to the next character position or left to a previous character position is achieved by the **→** (F4) and **←** (F3) keys respectively.

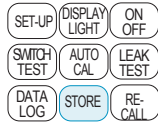

Numeric entries are added directly from the numeric keypad. The full alpha-numeric text is then appended to the stored file by pressing of the **ENT** key located on the numeric keypad. When all locations have been filled, subsequent operations of the **STORE** key cause previously stored data in the current location to be over-written.

3.11.8 Recall

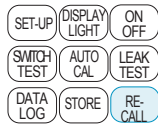

Recalls previously stored data to the display. Repeated operation steps back one location for each key-press and recycles when all twenty locations have been examined.

3.11.9 AutoCal



This function is used for both manual and automatic calibration routines. Automatic calibration routines are downloaded from an external system via the RS 232 interface port.

This function configures the instrument to store a large number of test data screen displays. The AutoCal log option provides two basic facilities **Test** and **Replay**.

In addition, two utility options are provided, **Directory** and **Delete**. When the AutoCal function has been selected, the function keys F1 to F4 are respectively allocated to the **Test**, **Replay**, **Directory** and **Delete** functions. This section provides a basic overview of these options. Full details of the operation of the AutoCal facility are given in Section 4.15.

- **Test**

The AutoCal **Test** mode is used to carry out calibration tests on devices and to automatically log all measurands associated with the test. Two AutoCal modes are provided, **Manual** and **Auto**.

- Manual

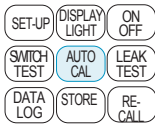

Initially, when the **Manual** option is selected, a facility is provided to have two types of display, **Pressure/Electrical** and **Pressure/Gauge**. **Pressure/Electrical** is the standard display and is selected by the **Yes** (F1) function key. **Pressure/Gauge** provides a facility to manually enter a pressure gauge reading against the DPI 605 pressure display for each Log operation and is selected by the **Dial/Gauge** (F2) function key.

Following selection of the desired display option, the instrument requires entry of the following parameters. Sequential prompts for data are requested as follows.

- Enter File ID:
- Transducer SN:
- Enter FSD of transducer:

Alpha numeric parameters may be entered in the File ID and Transducer SN: fields followed by **ENT**. The FSD field only accepts numeric characters entered via the numerical key-pad. Following entry of these parameters, the device under test is connected to the instrument and the required calibration test performed. At each way point, calibration data is stored by operation of the AutoCal **Log** key. The **Stop** key terminates an AutoCal manual calibration sequence and provides access to an analysis of results function as follows (e.g.)

- Analyse Results:
- BSL TSL ABS

These options are **Best Straight Line (BSL)**, **Terminal Straight Line (TSL)** and **Absolute (ABS)**. Both are straight line graphs of the form $y = mx + c$

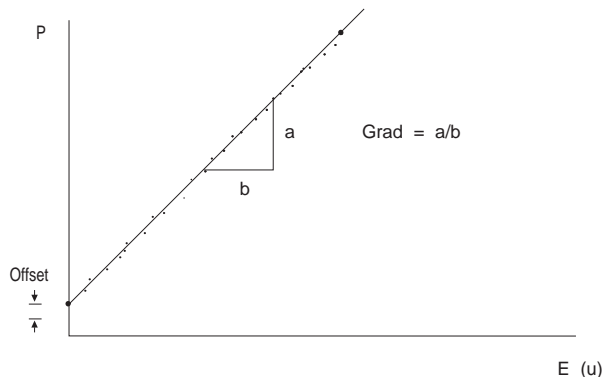

3.11.9 AutoCal (Contd....)

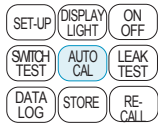

The **BSL** option calculates the best straight line taking every point measured into consideration whereas **TSL** draws the straight line between the lowest and the highest points.

ABS draws a straight line between a defined lower and higher point.

If **ABS** is selected, the instrument will immediately prompt for a zero point for the pressure reading (e.g.)

Zero input point:

Enter the required zero point and press **ENT**. The next prompt requests the zero point for a the corresponding electrical output (e.g.).

Zero output point:

Enter the electrical level corresponding to the zero output point and press **ENT**. The will automatically be in the selected units.

Repeat the necessary responses to the corresponding **FSD** level point prompts (e.g.).

FSD input point:

FSD Output point:

Following the entry of zero and full scale data for **ABS** or the selection of either **BSL** or **TSL**, the results sub-menu is written to the display as follows (e.g.).

TSL Result: -1.1% FS

Details	Results	Quit
---------	---------	------

For the selected straight line graph, **Details** provides a display showing the offset (vertical axis intercept) value and the gradient of the line (e.g.)

Ofst: -0.063u Grad 1.26 u/bar

Details	Results	Quit
----------------	----------------	-------------

'u' denotes units, where an external input is entered under the dial gauge option. Where electrical units are displayed, 'u' would be replaced by (e.g.) mA.

The Results option provides a display showing the maximum deviation from the straight line in terms of a percentage of full scale.

• Auto

This mode is selected when programmed AutoCal test sequences are loaded into the instrument from an external source via the RS 232 interface.

For each device to be tested, a series of pressure and/or electrical way points are programmed into the instrument. The operator carries out a test by connecting the device under test to the instrument and by operating the hand-pump (calibrator) or adjusting the applied pressure (indicator), until the pressure reaches a specified set-point. The measurands at this point are then recorded by manual operation of the **AutoCal** key. Following this, instructions to proceed to the next way point are given. Auto AutoCal routines are described in Section 4.15.

• Replay



The **Replay** option (F2) is used to either recall any selected AutoCal file to the display or to download the stored data to an external printer via the RS 232 interface port.

When Replay is selected, a directory, showing the first page of AutoCal logged files is displayed. To replay a AutoCal file, select the desired file by means of the **Page Up** (F1), **Page Down** (F2), **↑** (F3) or **↓** (F4) cursor keys and press the **ENT** key on the numeric key-pad.

Four display modes are then provided, these being termed **Display** (F1), **Graph** (F2), **Printer** (F3) and **Upload** (F4).

3.11.9 AutoCal (Contd....)

- **Display**

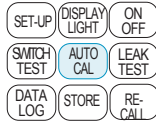

When **Display** is selected, the instrument prompts for a file ID number of an AutoCal file to be entered. Following entry of a file ID number, the data contained in the first location of the file is recalled to the display. Data in each sequential location can then be recalled by operation of the **Next** key (to go forward) or the **Previous** key (to go back). The end of file is indicated by the message **End**.

- **Graph**

The **Graph** option is used to provide a graphical indication of a selected AutoCal file. Three options are provided **PvT** (Pressure v Time), **EvT** (Electrical v Time) and **PvE** (Pressure v Electrical). A typical display is shown below.

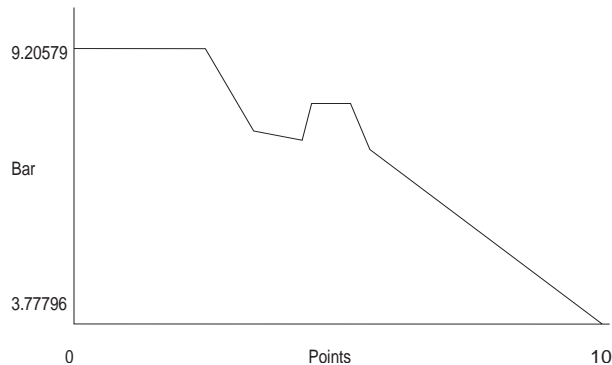

It should be noted that if the **Dial Gauge** display option has been selected, EvT gives a graphic output of **Dial I/P v Points** and **PvE**, **Pressure I/P v Dial Gauge** reading.

- **Printer**

Selection of the **Printer** option enables all data associated with the selected replay file to be downloaded to a printer. To make use of this option, a printer must be connected to the RS 232 interface. The appropriate printer must also have been selected from the Set-up Menu. Refer to Section 3.11.3 (Printer).

- **Upload**

This option is used to transmit (**Upload**) AutoCal data to an external system via the RS 232 port. Note that the RS 232 port must be configured in the correct way for the external system. RS 232 configuration is carried out under the **Set-up** option. Refer to Section 3.11.3 (COMMS).

- **Directory**

The AutoCal **Directory** option provides access to two directories, a Tests directory and a Results directory. The relevant directories are selected by the **Tests** (F1) and **Results** (F2) keys. Both directories are listed in the order in which the AutoCal operations were carried out. For **Auto** AutoCal, this means the order in which the tests were programmed and the results collected. Typical directory listings are as follows.

AutoCal Tests	Free Blocks 9212
TS150000000000000001	N123454367011111112
TS150000000000000002	N123454367011111113
TS150000000000000008	N123454367011111114
TS150000000000000032	N123454367011111115
TS150000000000000033	N123454367011111116
Page Up Page Down	

AutoCal Results	Free Blocks 9196
TS150000000000000001	N123454367011111112 >1
TS150000000000000002	N123454367011111113 >1
TS150000000000000008	N123454367011111114 >1
TS150000000000000032	N123454367011111115 >1
TS150000000000000033	N123454367011111116 >1
Page Up Page Down	

The (e.g.) **Free Blocks 9196** legend gives an indication of remaining memory space and the first five entries in the directory are displayed. The **Page Up** and **Page Down** functions, allocated to the F1 and F2 keys respectively, provide a means of scrolling forward (**Page Down**) or back (**Page Up**) through the directory listing. The **Exit Menu** key is used to return to the main AutoCal menu. Please refer to Section 3.11.5 - Data Log, for information regarding Memory Space.

The >1 symbol in the results directory indicates the result obtained from a first test . A >2 symbol indicates the results of the last test on a device.

3.11.9 AutoCal (Contd....)

- Delete

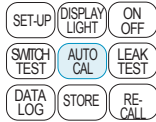

This AutoCal function enables files to be deleted from the AutoCal memory. Selection of the AutoCal **Delete** function (F4) initially provides the option to delete files located in either the Tests directory or the Results directory. The appropriate directory is selected by means of either the **Tests** (F1) or **Results** (F2) keys. Selection of one of these directories produces the appropriate directory listing, typical listings are shown below.

AutoCal Tests		Free Blocks 9212	
TS150000000000000001		N123454367011111112	
TS150000000000000002		N123454367011111113	
TS150000000000000008		N123454367011111114	
TS150000000000000032		N123454367011111115	
TS150000000000000033		N123454367011111116	
Page Up	Page Down	↑	↓

Typical Tests Directory

AutoCal Results		Free Blocks 9196	
TS150000000000000001		N123454367011111112 >1	
TS150000000000000002		N123454367011111113 >1	
TS150000000000000008		N123454367011111114 >1	
TS150000000000000032		N123454367011111115 >1	
TS150000000000000033		N123454367011111116 >1	
Page Up	Page Down	↑	↓

Typical Results Directory

The **Page Up** and **Page Down** keys are used to select the appropriate directory page and the ↑ and ↓ keys to select the file on the page.

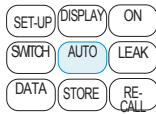

To delete a selected file, position the cursor against the file name and press the **ENT** key on the numeric key-pad. Providing the file is not password protected, a pre-delete warning is displayed as follows.

Delete - Are you Sure?
Yes No

The file is deleted on subsequent operation of the **Yes** (F1) key or the Delete operation aborted by operation of the **No** (F2) key.

If a file is password protected, following operation of the **Yes** (F1) key, a prompt is given for the corresponding password as follows.

Enter File Protection Number

Enter the password (a number within the range 1 to 9999) followed by **ENT**.

Test Equipment Depot - 800.517.8431 - 99 Washington Street Melrose, MA 02176
FAX 781.665.0780 - TestEquipmentDepot.com

4 OPERATION

4.1 Safety

4.1.1 Pressure Safety Instructions



ALWAYS CHECK FOR TRAPPED PRESSURE BEFORE CONNECTION/DISCONNECTION OF PRESSURE COUPLINGS. THE PRESSURE CAN BE VENTED BY MEANS OF THE VENT VALVE.

ENSURE THAT CORRECTLY RATED PIPE FITTINGS ARE USED.

4.1.1 Electrical Safety Instructions



WHEN FITTING ALKALINE BATTERIES IN PLACE OF THE RECHARGEABLE BATTERY PACK, USE ONLY THE RECOMMENDED TYPES OF CELL. THE RECOMMENDED TYPE IS INDICATED ON THE BATTERY COMPARTMENT COVER LOCATED ON THE UNDERSIDE OF THE INSTRUMENT.

REPLACE ALL SIX CELLS AT THE SAME TIME.

4.2 General

This section, which describes the use of the DPI 605 instrument has been structured on a functional basis.

The DPI 605 calibrator can generate and indicate pressures up to 20 bar gauge. The instrument's primary pressure indicator range, limited to 20 bar gauge (21 bar absolute with the barometric option), can be extended to 700 bar by the use of external transducers.

The DPI 605 Indicator can indicate pressures up to 350 bar gauge (with barometric option fitted). Its operating range can be extended to 700 bar by means of external transducers.

In addition to the pressure generation facility, both the calibrator and indicator instruments can generate electrical output voltages and currents. These electrical outputs can be programmed to any level within the range of the instrument or be linearly related to any measurand, programmable to a user defined straight line.

A digital multimeter (DMM), comprising an auto-ranging 0 - 50 V d.c. voltmeter and single range (0 - 55 mA) milli-ammeter, is built into the instrument to permit the monitoring of voltage and current signals.

The instrument has a temperature measurement facility (using an optional external PT100 platinum resistance probe). An RS 232 interface is also provided.

4.2.1 Menu Icons

In the following sections, the menu driven operations of the instrument are supported by icons to show the structures associated with each command. A typical icon is shown below, together with a description.

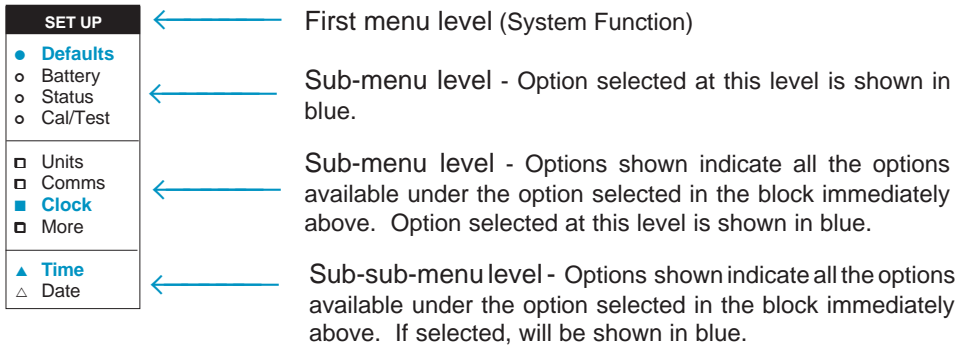

By working down the icon from the top to bottom, the key sequence for the system function at the lowest level is obtained. The example on page 4-1 shows the key sequence required in order to change the instrument's system time i.e. SET-UP/Defaults/Clock/Time.

4.3 Installation

General installation details are described in Section 2., Page 2.4 et seq.

4.4 Switching ON and OFF

The instrument is switched on by means of the **ON/OFF** key located on the keyboard. After switch on, a short initiation period follows during which the valves (Calibrator only) are set to the correct states. When the instrument displays pressure and electrical readings it is ready for operation.

A **Low Battery** warning is given when the internal rechargeable battery pack or alkaline batteries (if fitted), are approaching exhaustion. An approximate operating time of 1 minute is left when the **Battery Low** warning is given.

● Check Battery Status

The DPI 605 (IS) calibrator and indicator instruments are powered either by an internal rechargeable Nicad pack or by Alkaline D-Cells. The battery status can be checked from the Setup menu as follows.

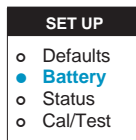

- Select Setup by pressing the **Setup** key.
- Select **Battery** (F2) from the Setup menu. The battery status will now be indicated (e.g.).

Battery = 7.88 V Good

- When a battery poor indication is given or the battery warning indicator is displayed, if alkaline batteries are fitted, replace them. If a rechargeable battery pack is fitted either plug-in the charger or replace the battery pack. Details for the charging of the internal NiCad pack or the fitting of Alkaline batteries are given in Section 2.

● Care of Rechargeable Batteries

The instrument is fitted with an internal rechargeable battery pack. The battery pack is fitted with its own connector and is equipped with an internally mounted, thermal fuse. The fuse is self resetting. The following general precautions should be observed with rechargeable batteries.

- **NEVER SHORT OUT THE BATTERY TERMINALS.**
- Do not leave a battery in a discharged state.

- Only use the charger supplied with the instrument to recharge the battery.
- If practical, run the battery until the instrument provides a **Low Battery** warning and then fully charge the battery. Avoid partial charge/discharge cycles if possible.
- **DO NOT attempt to open the battery case.**

Alkaline cells, if fitted, are isolated from the instrument's battery charger. No type of discharged primary cell should be left in the instrument.

4.5 Instrument Set-up

The instrument is supplied calibrated. A number of other parameters are also factory set as follows.

- | | | |
|---------------------------------|---|---------------------------------|
| ● Time | - | Set to U.K. local time |
| ● Date | - | Set to current date |
| ● Contrast | - | 50% |
| ● Display Light | - | Set to switch off after 5 sec. |
| ● Auto Off | - | Disabled |
| ● Display Rounding (Resolution) | - | Set to maximum |
| ● Initial Pin Number | - | Set as 123 |
| ● On State | - | Set to restore last Set-up (ON) |
| ● Keyboard | - | All functions enabled |

4.5.1 First Time Operation

- (Set P.I.N.)

Access to the DPI 605 calibration utilities are password protected, a factory set password (123) is entered into every instrument delivered. To set a new P.I.N. number, proceed as follows.

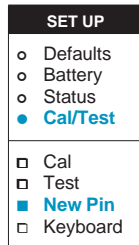

- Switch the instrument to ON.
- Press the **SET-UP** key.
- Select **Cal/Test** (F4) from the Set-up menu. The instrument will now prompt for entry of the current password as follows.

Cal/Test - Enter Pin Number:

- Enter the P.I.N. number (123) on the numeric key-pad and press **ENT**. The instrument now displays the Cal/Test menu (e.g.).

Cal/Test menu

Cal Test New Pin Keyboard

- Select **New Pin** (F3) and a prompt is given for a new P.I.N. number (e.g.).

Enter new Pin number

Enter key alone sets no Pin number

4.5.1 First Time Operation (Contd....)

SET UP	
<input type="radio"/>	Defaults
<input type="radio"/>	Battery
<input type="radio"/>	Status
<input checked="" type="radio"/>	Cal/Test
<hr/>	
<input type="checkbox"/>	Cal
<input type="checkbox"/>	Test
<input checked="" type="checkbox"/>	New Pin
<input type="checkbox"/>	Keyboard

- Enter a new P.I.N. number via the numeric key-pad and press **ENT**.
- At the **Verify new Pin number** prompt, enter the new P.I.N. number via the numeric key-pad and press **ENT**. If the new P.I.N. number is entered correctly, the instrument responds with **Verification OK** and exits the Set-up mode. If the new P.I.N. number is entered incorrectly, at the **Verify New Pin Number** prompt, the instrument responds with **Pin numbers do not agree** and exits the set-up mode and the old P.I.N. number is retained.

CAUTION : THE INSTRUMENT CALIBRATION CAN BE LOST BY INCORRECT USE OF THE CALIBRATE FACILITY.

● Instrument Clock Time and Date

To set-up the instrument Clock Time and Date proceed as follows.

SET UP	
<input checked="" type="radio"/>	Defaults
<input type="radio"/>	Battery
<input type="radio"/>	Status
<input type="radio"/>	Cal/Test
<hr/>	
<input type="checkbox"/>	Units
<input type="checkbox"/>	Comms
<input checked="" type="checkbox"/>	Clock
<input type="checkbox"/>	More
<hr/>	
<input type="checkbox"/>	Time
<input type="checkbox"/>	Date

- Switch the instrument to ON.
- Press the **SET-UP** key. The following display prompt will be shown (e.g.),

Set-up menu

Defaults Battery Status Cal/Test

- Press the F1 Function key to select **Defaults** option.
- Press the F3 Function key to select **clock**. The following display prompt will be shown (e.g.),

Set time and date 14:58:20 08/02/93

Time Date

- Select the **Time** option (F1) and at the prompt, enter the relevant time (hours) (e.g.),

Enter new Time (Hours.Mins):

- Enter the new time in hours and minutes format via the numeric key-pad, using the decimal point as a delimiter.
- Press **ENT** to accept the entered value.
- Select the **Date** option. Enter the new date in **Day, Month** and **Year** format via the numeric key-pad, using the decimal point as a delimiter.
- Press **ENT** to accept the entered date.
- **Display Contrast**

When the instrument is first supplied, the display contrast is factory set to 50%. To change the setting, proceed as follows.

SET UP
● Defaults
○ Battery
○ Status
○ Cal/Test
□ Units
□ Comms
□ Clock
■ More
□ Printer
■ Contrast
□ Auto Off
□ More
△ Up
△ Down

- Switch the instrument ON.
- Press the **SET-UP** key and select the **Defaults** option (F1).
- Select the **Contrast** option from the Defaults menu. Note the Contrast option is one level down on the Defaults menu and is obtained by pressing the **More** (F4) key on the first level.
- Use the **Up** (F1) or **Down** (F2) key to change the contrast level. **Up** causes the display to go darker and **Down** to go lighter.
- Press the **Exit Menu** key three times to exit **SET-UP**.

4.5.1 First Time Operation (Contd....)

- **Auto Off**

The functions available in this category of the Defaults menu allow the auto off features of the instrument to be Set-up. There are two options available, **Power** and **Light**.

- **Power**

SET UP
<ul style="list-style-type: none"> ● Defaults ○ Battery ○ Status ○ Cal/Test
<ul style="list-style-type: none"> □ Units □ Comms □ Clock ■ More
<ul style="list-style-type: none"> □ Printer □ Contrast ■ Auto Off □ More
<ul style="list-style-type: none"> ▲ Power △ Light

- Switch the instrument to ON.
- Press the **SET-UP** key.
- Select **Defaults** (F1) from the Set-up menu.
- Select **Auto-off** from the Defaults menu. Note that **Auto-off** is on the second level of the Defaults menu and is obtained by pressing the **More** key (F4) on the first level menu.
- Select **Power** (F1). Enter the required time-out period (in minutes) on the numeric keyboard, followed by **ENT**.
- Enable the Power off function by pressing the **Enable** key (F3). Conversely, disable the function by pressing the **Disable** key (F4)

- **Light**

SET UP
<ul style="list-style-type: none"> ● Defaults ○ Battery ○ Status ○ Cal/Test
<ul style="list-style-type: none"> □ Units □ Comms □ Clock ■ More
<ul style="list-style-type: none"> □ Printer □ Contrast ■ Auto Off □ More
<ul style="list-style-type: none"> △ Power ▲ Light

- Switch the instrument to ON.
- Press the **SET-UP** key.
- Select **Defaults** (F1) from the Set-up menu.
- Select **Auto-off** from the Defaults menu. Note that **Auto-off** is on the second level of the Defaults menu and is obtained by pressing the **More** key (F4) on the first level menu.
- Select **Light** (F2). Enter the required time-out period (in seconds) on the numeric keyboard, followed by **ENT**.
- Enable the Light off function by pressing the **Enable** key (F3). Conversely, disable the function by pressing the **Disable** key (F4).

4.5.2 Set-up Units

- **Pressure**

Instruments delivered to the UK are supplied with their pressure scales programmed to specific function keys as follows, **bar** (F1), **psi** (F2), **MH2O** (F3) and **kPa** (F4). Instruments supplied to the U.S. are programmed to give **psi** (F1) **inHg** (F2), **inH2O** (F3) and **kPa** (F4). Instruments supplied to Japan are programmed to give **kg/cm2** (F1), **mH2O** (F2), **mmHg** (F3) and **mbar** (F4).

To change any default settings, proceed as follows,

SET UP	
● Defaults	
○ Battery	
○ Status	
○ Cal/Test	
■ Units	
□ Comms	
□ Clock	
□ More	
▲ Pressure	
△ Spec'l	
△ Temp.	

- Switch the instrument to ON.
- Press the **SET-UP** key.
- Select **Defaults** (F1) from the Set-up menu.
- Select **Units** (F1) from the Defaults menu.
- Select **Pressure** (F1) from Defaults Units Selection menu.

Operation of this key displays full range of units available together with an indication of the units to which each function key is currently assigned.

bar	kg/m2	torr	ftH2O
Pa - F4	mmHg - F3	atm	ftH2O4
hPa	cmHg	psi - F2	Spec'l
kPa	mHg	lb/ft2	Blank
MPa	mmH2O	inHg	Blank
mbar - F1	cmH2O	inH2O	Blank
kg/cm2	mH2O	inH2O4	

The default setting for any key is changed by pressing the required function key. This will cause it to scroll through the menu, missing out units assigned to the other function keys. The key is assigned the unit beside which it is displayed. Assigning three function keys to **Blank** provides the facility of setting up the instrument for single pressure unit operation.

4.5.2 Set-up Units (Contd....)

- **Spec'I**

The instrument has the facility to enable the operator to set-up a special conversion factor for the pressure reading. When the special factor is selected, the display pressure units are in Pascals. The default setting of the Pascals to Spec'I conversion factor is 100 (scaling the pressure display in hPa).

By entering a conversion factor (Pascals to Spec'I unit factor) under Set-up, the instrument can be made to read any required unit. To change the default setting of the Special factor, proceed as follows.

SET UP	
●	Defaults
○	Battery
○	Status
○	Cal/Test
■	Units
□	Comms
□	Clock
□	More
△	Pressure
▲	Spec'I
△	Temp.

- Switch the instrument to ON.
- Press the **SET-UP** key.
- Select **Defaults** (F1) from the Set-up menu.
- Select **Units** (F1) from the Defaults menu.
- Select **Spec'I** (F2) from the Default Units Selection menu. The instrument now displays a prompt showing the current conversion factor and requesting entry of a new factor (e.g.)

Pascals to Spec'I Factor: □ 100.00

- Enter the required conversion factor on the numeric keypad and press **ENT**.
- Press **Exit Menu** four times to exit Set-up.
- Assign a function key to Spec'I and select Units on the Pressure keypad and select Spec'I.

NOTE: If the **Spec'I** conversion factor is changed whilst the **Spec'I** Units factor is selected, the **Spec'I** Units factor will have to be re-selected in order to make use of the new conversion factor.

● Temperature

Instruments are supplied with their temperature scales set to degrees Celsius (°C). To change the default setting, proceed as follows,

SET UP	
● Defaults	
○ Battery	
○ Status	
○ Cal/Test	
■ Units	
□ Comms	
□ Clock	
□ More	
△ Pressure	
△ Spec'l	
▲ Temp	

- Switch the instrument to ON.
- Press the **SET-UP** key.
- Select **Defaults** (F1) from the Set-up menu.
- Select **Units** (F1) from the Defaults menu.
- Select **Temperature** (F3) from the Defaults Units Selection menu.
- Select the required temperature units °C (F1) or °F (F2) from the **Select Temperature Units** Menu.

4.5.3 Set-up Data Communications

● Comms

To set-up the instrument's data communications parameters, proceed as follows,

SET UP	
● Defaults	
○ Battery	
○ Status	
○ Cal/Test	
□ Units	
■ Comms	
□ Clock	
□ More	
△ Baudrate	
△ Parity	
△ Handshake	
△ Scpi	

- Switch the instrument to ON.
- Press the **SET-UP** key.
- Select **Defaults** (F1) from the Set-up menu.
- Select **Comms** (F2) from the Select Default Settings menu.

Selecting Comms from the Default Settings menu provides a status report of the currently set Comms parameters and the facility to set-up the **Baudrate** (F1), **Parity** (F2), **Handshake** (F3) and **Scpi** (F4) parameters of the RS232 communications protocol (e.g.),

Baudrate:9600	parity: none	HS: Hardware
Baudrate	Parity	Handshake
		Scpi

4.5.3 Set-up Data Communications (Contd....)

SET UP	
●	Defaults
○	Battery
○	Status
○	Cal/Test
□	Units
■	Comms
□	Clock
□	More
▲	Baudrate
△	Parity
△	Handshake
△	Scpi

■ Baud-rate

This option allows the baud-rate to be set-up via the **Previous** (F1) and **Next** (F2) keys. The current setting is indicated by an arrow. A typical Baud-rate display is shown below.

Select baud-rate

110	600	4800
150	1200	9600 ←
300	2400	19.2K

Previous **Next**

After setting up the required baud-rate, press **Exit Menu** to return to the Comms sub-menu. Repeat **Exit Menu** operations until the Set-up option clears.

SET UP	
●	Defaults
○	Battery
○	Status
○	Cal/Test
□	Units
■	Comms
□	Clock
□	More
△	Baudrate
▲	Parity
▲	Handshake
△	Scpi

■ Parity

This option allows the RS 232 parity checking mode to be set-up. Three options are available **Odd** (F1), **Even** (F2) and **None** (F3).

■ Handshake

Selection of this option allows the RS 232 handshaking mode to be set-up. Four options are available, **None** (F1), **Software** (F2), **Hardware** (F3) and **Both** (F4).

SET UP	
●	Defaults
○	Battery
○	Status
○	Cal/Test
□	Units
■	Comms
□	Clock
□	More
△	Baudrate
△	Parity
△	Handshake
▲	Scpi

■ Scpi

Selection of this option allows the local echo of the Scpi commands to be either switched on or off. Two options are available, **Echo on**(F1) or **Echo off** (F2).

4.5.4 Select Printer and Print Screen

● Printer

To select a printer, proceed as follows,

SET UP
<ul style="list-style-type: none"> ○ Defaults ○ Battery ○ Status ○ Cal/Test
<ul style="list-style-type: none"> □ Units □ Comms □ Clock ■ More
<ul style="list-style-type: none"> ■ Printer □ Contrast □ Auto Off □ More
<ul style="list-style-type: none"> △ Previous △ Next

- Switch the instrument to ON.
- Press the **SET-UP** key.
- Select **Defaults** (F1) from the Set-up menu.
- Select **Printer** from the Select Default Settings menu. The printer select option is on the second level of the Default Settings menu and is accessible by first of all pressing the **More** (F4) key on level 1.

Selecting the **Printer** option, (F3) from the Default Setting menu, provides a list of printers supported by the instrument (e.g.),

Printer Selection

Druck 40 column printer ←
80 column printer

Previous

Next

The currently selected printer is indicated by the position of the arrow. Use the **Next** (F2) and **Previous** (F1) keys to move the printer to the required printer. Press the **Exit Menu** key to return to the Default Settings menu.

● Print Screen

To print the screen, proceed as follows.

- Ensure that the external printer or computer is connected to the RS 232 port and that the port is correctly configured (See Section 4.5.3).
- Press the **DEL** and **ENT** keys on the numeric key-pad simultaneously. The display will then be printed (uploaded). In the event of any problems being encountered, the Print operation can be aborted by operation of the **Exit Menu** key.

NOTE: On earlier DPI 605 instruments, the Print Screen facility requires the **ENT** and **9** keys to be pressed simultaneously.

4.5.5 Pressure Display Resolution

The display resolution can, depending upon the range selected, be set-up to give a maximum of 6½ digits. To select the required resolution, proceed as follows.

SET UP	
●	Defaults
○	Battery
○	Status
○	Cal/Test
□	Units
□	Comms
□	Clock
■	More
□	Printer
□	Contrast
□	Auto Off
■	More
■	Resolution
□	On State
△	On
△	Off

- Switch the instrument ON.
- Press the **SET-UP** key.
- Select **Defaults** (F1) from the Set-up menu.
- Select **More** (F4) to gain access to second level of defaults.
- Select **More** (F4) to gain access to third level of defaults.
- Select **Resolution** (F1) option.
- In response to the prompt (e.g.).

Pressure display resolution dp's: 5

Enter the required number of digits by using the **Up** (F1) and **Down** (F2) keys. The display will round to the number of significant figures set.

NOTE: The Pressure display resolution is set for a specific combination of Pressure Units and Range. If either the Units or Range are subsequently changed, the Resolution previously set for those units and range will be recalled.

4.5.6 Change On-State

The DPI 605 is shipped with its Restore Last Set-up set to ON. In this state, any programmed functions (e.g.) Process function, will remain selected after the instrument has been switched off and back on again.

The exceptions are the **Ana. Output** and **Prog. Output**. These remain set-up at the last programmed level but are switched off on power-up.

To select the required On-State, proceed as follows.

SET UP	
●	Defaults
○	Battery
○	Status
○	Cal/Test
□	Units
□	Comms
□	Clock
■	More
□	Printer
□	Contrast
□	Auto Off
■	More
□	Resolution
■	On State
△	On
△	Off

- Switch the instrument to ON.
- Press the **SET-UP** key.
- Select **Defaults** (F1) option from the Set-up menu.
- Select **More** (F4) twice.
- Select **On State** (F2). This will report on the state of the on state function (e.g.).

Restore last set-up:	Off
On	Off

- Select **On** (F3) or **Off** (F4) as required

4.6 Generating a Pressure

The pressure generation controls of the instrument are shown in Fig. 4.1 and comprise the following.

- Vent Valve (2).
- Hand-pump (3).
- Volume Adjuster (4).
- Pressure Test Port (5).

The associated pressure control panel is shown below. A description of the controls is given in Section 3.

Note: It is not possible to generate a pressure with the indicator version of the instrument. Sections 4.6.1 and 4.6.2 still apply however to the indicator version of the instrument.

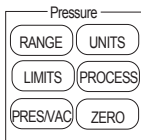

- Switch the instrument to ON by means of the **ON/OFF** key. The instrument will default to its internal pressure transducers and to the pressure mode.
- Press the **UNITS** key. Select the required pressure units from the four units displayed by pressing the associated function key F1, F2, F3 or F4. If the required units are not displayed, refer to SET-UP section 4.5.2.
- If required, press the **LIMITS** key and use the function keys to define the **Alarm** (F1) and **Safety Limits** (F2) for the test to be conducted.
- Ensure that the Vent Valve (2) is open and connect the device or system under test to the Pressure Port (5). Note, the Pressure Port (5) has a rotatable coupling with spanner flats provided. Slacken off the locking ring to allow the coupling to rotate.

CAUTION: ENSURE LOCKING RING IS TIGHTENED BEFORE APPLYING PRESSURE.

- Set the Volume Adjuster (4) to approximately half way.
- Zero the pressure display by means of the **ZERO** key.
- Set the instrument to **pressure** by means of the **PRES/VAC** key.
- Close the Vent Valve (2).
- Operate the Hand-pump (3) to set-up the required pressure. Use the Volume Adjuster (4) as a fine adjustment of the output pressure.
- Use the pressure **PROCESS** functions as required by the test in progress. The process functions are outlined in Section 3.

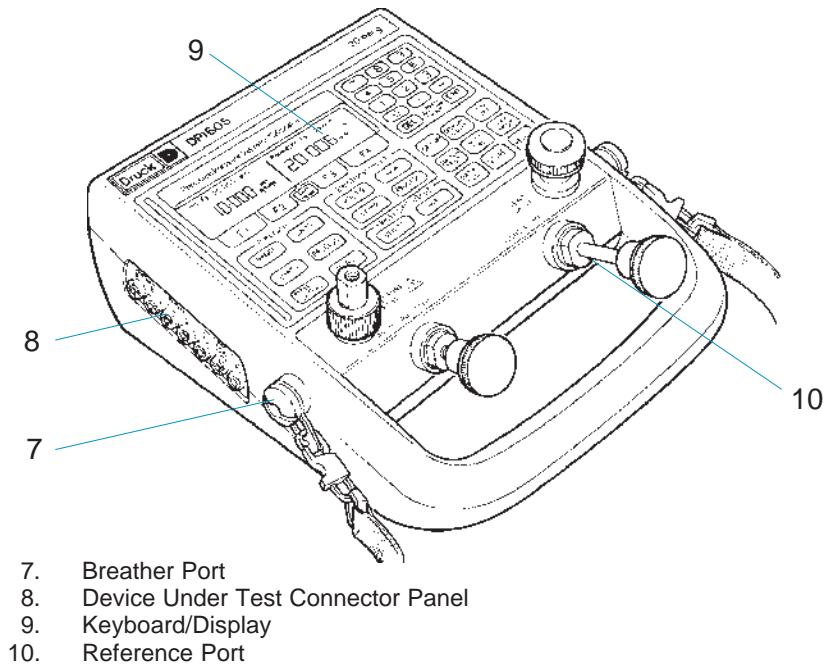
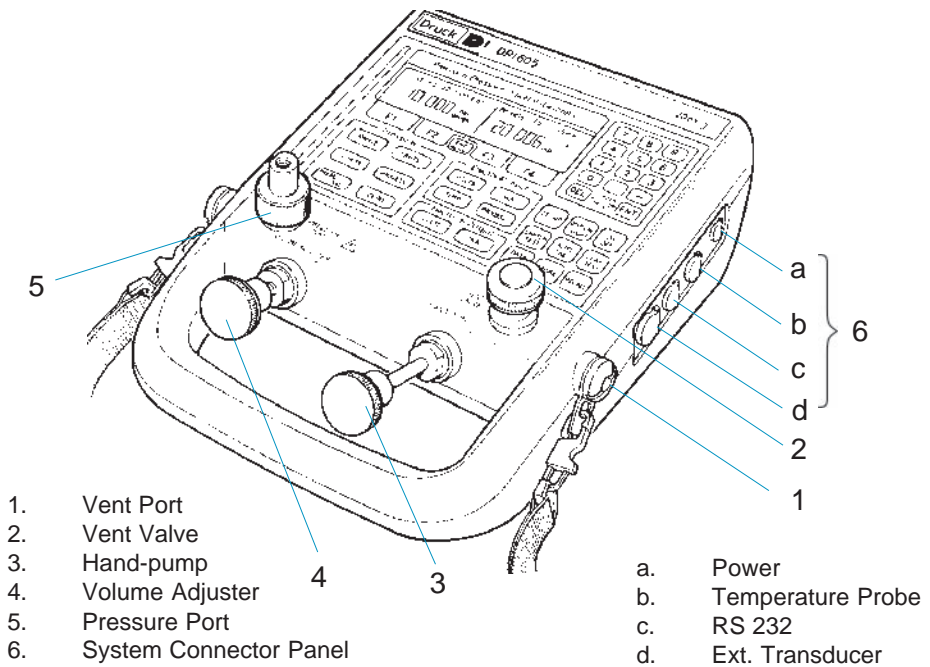

Figure 4.1 - DPI 605 Instrument Controls and Connectors (Calibrator)

4.6.1 Set Pressure Alarm and Safety Limits

To set-up the Alarm and Safety Limits, and assuming the instrument to be switched ON, proceed as follows,

● Alarm Limit



- Press the **LIMITS** key located on the pressure key-pad.
- Select the **Alarm** function key (F1) from the Pressure Limits Select menu. The current alarm level setting together with its status will now be indicated (e.g.),

Alarm Limit: Off Value: 18.000 bar

On Off

- Enter the required alarm level on the numeric key-pad and press **ENT**.
- Enable the alarm by pressing the **On** (F3) key. Conversely, disable the alarm by pressing the **Off** (F4) key.

● Safety Limit



- Press the **LIMITS** key located on the pressure key-pad.
- Select the **Safety** function key (F2). The current Safety Limits setting will now be indicated (e.g.),

Safety Limit: 14.45000 bar

- Enter the required Safety Limit on the numeric key-pad and press **ENT**.

Once set, the Safety Limit is always active and on calibration versions, will cause pump blocking to occur, **thereby preventing further system pressurisation**, when the Safety Limit threshold is reached. A continuous audible alarm is also given.

To cancel the alarm and release pump blocking, press the **Exit Menu** key. Note that until the system pressure falls below the set Safety Limit, pump blocking will be inhibited.

4.6.2 Selection of Pressure Process Functions

Five pressure process functions are provided on the instrument, **Tare**, **Peak**, **%F.S.**, **Filter** and **Flow**. All functions are accessible from the Pressure Processing Selection menu. Assuming the instrument to be switched on, the menu is accessible by pressing the **PROCESS** key and appears as follows (e.g.),

Pressure Processing Selection

Tare **Peak** **%F.S.** **More**

Access to the Filter and Flow process functions is gained by pressing the **More** (F4) key.

Note that if any of the following functions are enabled and the instrument is set to power-up as last set-up (see Section 4.5.6), the functions will remain enabled when the instrument next powers-up.

- **Tare**

The **Tare** function permits a programmable offset to be either subtracted from or added to the indicated pressure reading. To enter the **Tare** function, proceed as follows,

PROCESS	
●	Tare
○	Peak
○	% FS
○	More
△ Reading	
△ Manual	
△ On	
△ Off	

- Select Process by pressing the **PROCESS** key located in the Pressure key-pad.
- Press the **Tare** (F1) key. A menu showing the status of the Tare process is now displayed (e.g.),

Pressure Tare: Off Value: 1.45000 bar

Reading Manual On Off

4.6.2 Selection of Pressure Process Functions (Contd....)

- Either press the **Reading** (F1) key to set the currently indicated value as the Tare value or press **Manual** (F2). If **Manual** is selected, enter the required Tare value on the numeric key-pad and press **ENT**. Note that any Tare value entered will be subtracted from the indicated pressure reading. If a Tare value requires adding to the indicated pressure reading, a negative number should be entered.
- Enable the **Tare** function by pressing the **On** (F3) key. Conversely, the **Tare** function is disabled by pressing the **Off** (F4) key. A **T** symbol is displayed beside the pressure display to indicate when the function is enabled.

- **Peak**

The Peak function is used to reconfigure the instrument's pressure window to read the positive and negative peaks of the pressure reading. To select the Peak function, proceed as follows,

PROCESS	
○	Tare
●	Peak
○	% FS
○	More
△ Clear	
△ Manual	
△ On	
△ Off	

- Select Process by pressing the **PROCESS** key located in the Pressure key-pad.
- Press the **Peak** (F2) key. A menu showing the status of the Tare process is now displayed (e.g.),

Peak Display

Clear

On

Off

- Enable the **Peak** function by pressing the **On** (F3) key. The current peak display can be reset by operation of the **Clear** (F1) key. The **Peak** function is disabled by pressing the **Off** (F4) key,

Note that the Peak function may have to be re-selected to turn off the facility or to clear the peak display.

4.6.2 Selection of Pressure Process Functions (Contd....)

- **Flow**

The **Flow** function is selected as follows,

PROCESS	
○	Tare
○	Peak
○	% FS
●	More
○	Filter
●	Flow
○	More
△	On
△	Off

- Select Process by pressing the **PROCESS** key located in the Pressure key-pad.
- Press the **More** (F4) key followed by the **Flow** (F2) key. The Pressure Flow menu will now be displayed (e.g.)

Pressure Flow

On **Off**

- Enable the **Flow** function by pressing the **On** (F1) key. A symbol √ will be displayed to show that Flow has been selected.
- To disable the Flow function, press the **Off** (F2) key.

4.7 Generating a Vacuum (not applicable to Indicator versions)

The vacuum generation controls of this version of the instrument are shown in Fig. 4.1 and comprise the following.

- Vent Valve (2).
- Volume Adjuster (4).
- Hand-pump (3)
- Pressure Test port (5).

The associated pressure control panel is shown below. A description of the controls is given in Section 3. To generate a vacuum, proceed as follows.

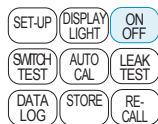

- Switch the instrument to ON by means of the **ON/OFF** key. The instrument will normally default to its internal pressure transducers and to the pressure mode. If, however, the instrument was switched off, leaving a “sealed in” pressure, it will remain in the pressure mode.

NOTE: *The instrument cannot be directly switched from **pressure** to **vacuum** from a pressurised state.*

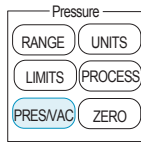

- Open the Vent Valve (2).
- Press the **PRES/VAC** key to select the vacuum mode.
- Close the Vent Valve (2).
- Operate the Hand-pump (3) to generate the required vacuum.

4.8 Measuring a Pressure

To use the instrument for measuring a pressure proceed as follows.

- Ensure that the pressure or vacuum to be monitored is not likely to exceed the operating range of the instrument (**-1 to 20 bar max for calibrator versions**). Refer to Specification, Section 1.3.

IF IN ANY DOUBT, CHECK BEFORE CONNECTING THE INSTRUMENT

- Switch the instrument **ON** by means of the **ON/OFF** key. The instrument will default to its internal pressure transducers and to the pressure mode.
- Press the **UNITS** key and use one of the function keys (F1 to F4) to select the required pressure units. If the required units are not displayed, refer to Section 4.4.
- If required, press the **LIMITS** key and use the F1 and F2 keys to define an Alarm Limit for the test to be conducted (see Section 4.6.1).
- Ensure that the Vent Valve (2) is open and connect the unit or system under test to the Pressure Port (5).
- Before applying the external pressure/vacuum level, zero the pressure display by means of the **ZERO** key.
- Close the Vent Valve (2).
- Apply the external pressure.
- Use the **PROCESS** function to define any pressure processing which may be required (see Section 4.6.2).

4.8.1 Connection of External Pressure Transducers

To connect an external transducer to the instrument, proceed as follows.

RANGE
<input type="radio"/> 20 bar G
<input type="radio"/> 21 bar A
<input type="radio"/> Barometer
<input checked="" type="radio"/> External
<input type="checkbox"/> Previous
<input type="checkbox"/> Next
<input type="checkbox"/> None
<input type="checkbox"/> Select

- Plug the transducer into the socket - labelled **EXT** transducer.
- Press the **RANGE** key.
- Select **External** (F4).
- Using the **Previous** (F1) and **Next** (F2) keys, select the required transducer serial number from the table.
- Check that the serial number of the external transducer matches the serial number selected in the table.
- Select the external transducer by pressing the **Select** (F4) key.

It should be noted that calibration routines for external transducers, which includes the specification of serial numbers, are given in Section 6. If digitally compensated external transducers are used, selection of the plugged in transducer is automatic.

If **None** (F3) is selected from the External Range Menu, the pressure display defaults to reading mV.

4.9 Leak Test

To carry out a leak test with the instrument, proceed as follows.

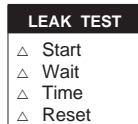

- Open the Vent Valve (2) to depressurise the instrument.
- Connect the system or device under test to the Pressure Port (5).
- Remove any zero offset by pressing the zero key.
- Select **LEAK TEST** on the blue mode select keys. Four options will now be displayed over the function keys; **Start** (F1), **Wait** (F2), **Time** (F3) and **Reset** (F4). The dialogue line of the display will also show the function and the currently set **Wait** and **Time** parameters (e.g.).

Leak Test: Wait 00:01:30 Time 00:00:20

The electrical window is also re-configured to show (e.g.).

Pressure Drop

Leak Rate

- If required, press the **Wait** function key (F2) and enter the required wait period (in seconds) on the numeric keys, followed by the **ENT** key. This parameter defines the delay period between the pressing of the **Start** key and commencement of the measurement period. A period of 60 seconds (minimum) is recommended.
- Set-up the required test duration period by pressing the **Time** key and entering the required test duration period on the numeric keys, followed by **ENT**.
- Close the Vent Valve (2) and, using the Hand-pump (3), pump up the system pressure to the desired level. Use the Volume Adjuster (4) to make fine adjustments of pressure.
- Press the **Start** (F1) key. The instrument display will now indicate **Leak Test Running** and start the countdown of the Wait period (indicated by the Wait period display counting down to zero). After termination of the Wait period, the Time display commences a countdown from the set period to zero. The measuring time of the Test period is indicated by the display counting down to zero.

At the end of the Test period, the display will indicate **Pressure Drop** and **Leak Rate** in the currently selected units.

- If required, press the **STORE** key to store the current information.
- Press the **Reset** key (F4) to clear the display in readiness for another leak test.

NOTE: If whilst setting-up the instrument, the display times out (indicated by the disappearance of the legends over the function keys), press the **Leak Test** key again to re-activate the function keys.

4.10 Generating an Electrical Output

The electrical outputs of the DPI 605 are taken from the Device Under Test (DUT) Connector Panel. There are two basic options available for the electrical outputs.

- **Programmable Output.**

Direct output of a user defined output voltage or current.

- **Analogue Output**

Output of a voltage or current proportional to a selected measurand. Full Scale (F.S.) and zero output levels must be defined. The instrument connections for these facilities are shown in Fig. 2-10, (Section 2.1.9).

The maximum output voltage that can be supplied is 24 V d.c. with a 50 mA current drive capability. The maximum output current that can be sourced from the instrument is 55 mA from a 19V source (30 V when the instrument is connected to an external power supply).

4.11 Generation of Output Voltages or Currents (Prog. Output)

- To generate an output voltage or current, proceed as follows.

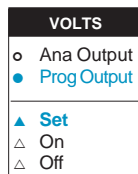
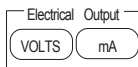

- Switch the instrument to ON by means of the **ON/OFF** key. The electrical outputs from the instrument will default to OFF.
- Configure the output by pressing either the **Volts** or **mA** keys.
- Select **Prog Output (F3)**.

- Press the **Set** key (F1) and enter the required output level, either by means of the **Up/Down** function keys (F3) and (F4) or by direct numerical value entry from the keyboard, followed by **ENT**.

VOLTS	
○	Ana Output
●	Prog Output
△	Set
▲	On
△	Off

- Connect the external load to the appropriate sockets as shown in Fig. 2-10. Use the **B(+)** and **C(-)** sockets for voltage and current sourcing applications and the **C(+)** and **D(-)** sockets for current sinking applications (see Fig 2-11).
- Set the output to ON by means of the **On** (F3) KEY. When the output is switched ON, the output voltage level is displayed in the lower of the two electrical windows. Note that the digital voltmeter/ammeter can be used to monitor the output level.
- To disable the programmable output, press the **Off** (F4) key or alternatively, select another type of output i.e. if **VOLTS** selected, select **mA**. The latter method maintains the instrument in the output programming mode.

It should be noted that if the instrument is subsequently switched off whilst the analogue output is enabled, when the instrument is next switched on, the last analogue value set-up will be retained but the output will be switched off. To enable the output again, press **VOLTS** or **mA** as appropriate on the electrical output Key-pad, followed by the **On** (F3) function key.

4.12 Set an Analogue Output Proportional to an Indicated Measurand

To set-up the instrument to provide an analogue output proportional to an indicated measurand, proceed as follows.

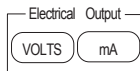

- Switch the instrument ON by means of the **ON/OFF** key. The analogue output will default to OFF.
- Configure the output for either voltage or current by pressing either the **VOLTS** or **mA** key.

VOLTS	
<input checked="" type="radio"/>	Ana. Output
<input type="radio"/>	Prog Output
<input checked="" type="checkbox"/>	Pressure
<input type="checkbox"/>	Electrical
<input type="triangle-up"/>	Set-up
<input type="triangle-up"/>	On
<input type="triangle-up"/>	Off

- Select **Ana. Output** (F2) and, in response to the system prompt, **Select source of analogue output**, select either **Pressure** (F1) or **Electrical** (F2). Note that for an analogue output proportional to temperature, **Electrical** should be selected (Icon shown for pressure).
- A set-up prompt will now be displayed (e.g.),

Analogue output -Volts

Set-up On Off

- To define the linear relationship between the selected measurand (e.g.) Pressure and the analogue output (e.g.) Volts, press the **Set-up** (F1) key. A prompt for the lower point of the relationship will be displayed, together with the last parameter levels which were set-up (e.g.),

Lower Point 0.00000mbar = 0.0000V

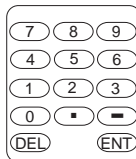

- Enter the required level for each parameter on the numeric keyboard and press **ENT**. Press the **Accept** (F1) key and a prompt for the upper point will then appear (e.g.)

Upper Point 500.00000mbar = 5.0000 V

- Enter the required level for each parameter on the numerical keyboard and press **ENT**. To return to the lower limit (if necessary) press **Accept** (F1).
- Press **Exit Menu** and enable the analogue output by pressing the **On** (F3) key. The lower section of the electrical display will now indicate the analogue output mode (e.g.) **Pressure to Volts**.
- To disable the analogue output, press the **Off** (F4) key or select another type of analogue output (e.g.) **mA**.

The instrument is now programmed to provide an analogue (voltage) output proportional to the indicated pressure. It should be noted that the electrical outputs are mutually exclusive i.e. the instrument has the capability of providing either a programmable voltage or current output or an analogue output (Voltage or Current) proportional to a measurand. It cannot provide both types of output simultaneously. The output appears across **B(+)** and **C(-)** sockets located on the left hand side panel of the instrument.

4.13 Pressure Switch Testing

The Switch Test function of the instrument allows the operating point of pressure switches to be accurately determined.

To carry out a **Switch Test** operation, proceed as follows.

- Ensure that the instrument is depressurised by opening the Vent Valve (2).
- Connect the pressure switch to the instrument as shown in Fig. 4.2, (See also Fig 2.9, Section 2).

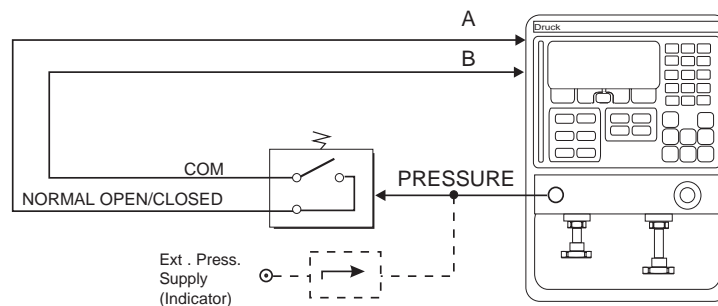
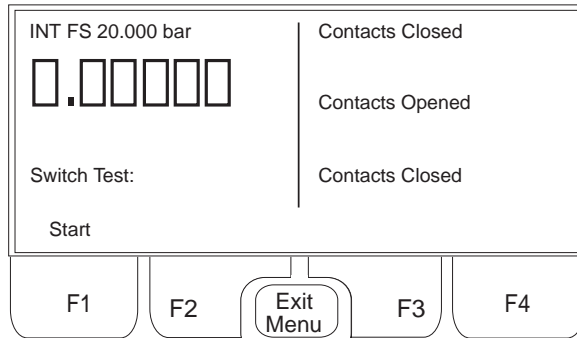

Figure 4.2 - Pressure Switch Test Connections

- Switch the instrument to ON by means of the **ON/OFF** key.
- Close the Vent Valve (2).

- Press the **Switch Test** key. The instrument responds with a flashing **Switch Test** indication and by displaying the current pressure and the status of the pressure switch contacts (e.g.)



- Press the **Start** (F1) key and use the Hand-pump (3) to generate an output pressure. Continue pumping until the switch contacts change state. For indicator version of the instrument, vary the applied pressure externally.

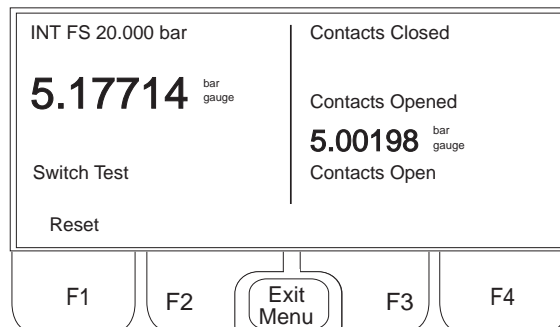

- Open the Vent Valve (2). As the system pressure drops, the calibrator records the pressure at which the pressure switch contacts change state (e.g.)

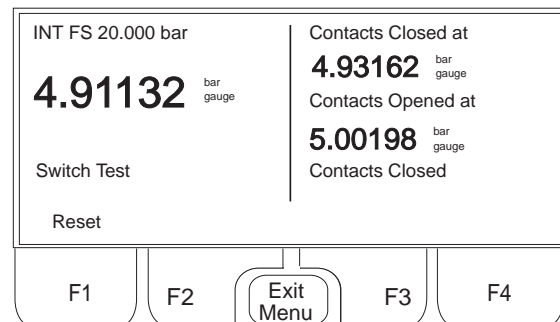

- If required, on completion of test, press the **STORE** button to store data associated with the test. The display will now show the hysteresis between the operating points of the pressure switch contacts.

Where a pressure switch has change over contacts, repeat the test for the other switch pole i.e., test both the normally open and normally closed contact sets. For pressure switches with multiple contact sets, repeat the test for each contact set.

- Press the **Reset** key (F1) to cancel the last test and set-up another.
- Press **Exit Menu** key to quit **Switch Test**.

4.14 Temperature Measurements

Two types of Platinum Resistance Temperature Probes may be used in conjunction with the instrument, a PT100 (for temperature ranges -55° to 250°C) and PT 25 (for temperature ranges -55° to 800°C). To ascertain which type is selected and to change the selection, if required, proceed as follows.

- Switch the instrument ON.
- Press the **Set-up** key and select **Defaults** (F4).
- Press the **More** (F4) key twice and select **Temp Probe** (F3). The instrument reports the currently selected temperature probe and provides the option to select another type (e.g.).

Temperature	Probe:	PT 100
PT 100	PT 25	

- Select the appropriate probe by means of either the **PT 100** (F1) or **PT 25** (F2) keys.
- Exit the set-up mode by pressing the **Exit Menu** key twice.

To carry out temperature measurements, proceed as follows.

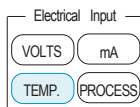

- Select **TEMP** on the Electrical Input Panel.

NOTE: If **TEMP** is selected and probe is not connected, or improperly connected, the display will read (e.g.)

Not Connected °C.

4.15 Data Log

The Data Log **Record** option of the instrument enables it to store a large number of complete screens. The function has two basic modes of operation, **Record** and **Replay**.

To perform a Data Log operation, proceed as follows.

- Switch the instrument ON.
- Set-up the instrument to display the required pressure and electrical measurands.

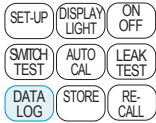

- Press the **DATA LOG** key. Selection of this function displays the Data Log Menu as follows (e.g.),

Data Log Menu

Record Replay Directory Delete

- To obtain a listing of the Data Log File names already used, press the **Directory** key (F3). (Refer to Section 4.15.1 for use of this utility).

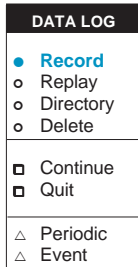

- Select **Record** (F1) from the Data Log Menu. A prompt to continue with the Data Log function or to **Quit** is now given (e.g.)

Will log the current display: 14:50:46

Continue

Quit

- Press the **Continue** (F1) function key. A file number is first requested, followed by a dialogue prompting for required start and stop parameters. Refer to Section 4.15.2 for details for the operation of the Data Log Record Mode.
- For details of the methods of replaying recorded Data Log data, refer to Section 4.15.3.

4.15.1 Use of Data Log Directory and Delete Utilities

- Directory

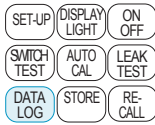

10846

Selection of the **Directory** (F3) option from the Data Log menu provides a list of all the completed Data Log operations that have been stored in the instruments' memory. These will be listed in the order in which the Data Log operations were carried out (not in file number order). A typical directory listing is shown below.

File ID (Data Log)		Free Blocks
A17966	28/01/93	15.37.10
A17222	28/01/93	15.40.03
C22713	28/01/93	15.51.32
C070842	28/01/93	15.51.32
B2	28/01/93	15.58.17
Page Up Page Down		

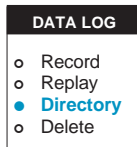

The (e.g.) **Free Blocks: 10846** legend gives an indication of the remaining memory space and the first page of the directory (five entries) is displayed. The **Page Up** and **Page Down** functions, allocated to the F1 and F2 keys respectively, provide a means of scrolling forward (to the next page) or back (to a previous page) of a directory listing. The **Exit Menu** key is used to return to the main Data Log menu. When first entering the Data Log functions, it is good practice to interrogate the directory. This will enable the operator to determine what File reference numbers have already been used, since an attempt to use an existing file ID number to record a Data Log operation will result in the display of an error message - **File already exists**.

- Delete

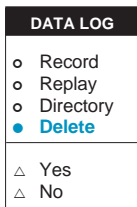

This Data Log function enables files to be detected from the Data Log memory. Selection of the function provides a directory listing and four cursor keys **Page Up** (F1), **Page Down** (F2), **↑** (F3) and **↓** (F4) (e.g.)



Numeric entries are added directly from the numeric key-pad. The full alpha-numeric text is added to the file by pressing the **ENT** key, located on the numeric key-pad.

- Following entry of the file number, the instrument prompts for the selection of a trigger mode as follows (e.g.),

Select trigger for Data Logging

Periodic

Event

DATA LOG	
●	Record
○	Replay
○	Directory
○	Delete
■	Continue
□	Quit
▲	Periodic
△	Event
◇	Stop Time
◇	Samples

■ Periodic Mode

The **Periodic** trigger mode (F1) is basically an internally generated trigger mode which permits the Data Logger to be controlled either by programmable times or by the number of samples taken. The frequency of sampling (in seconds) is first of all defined followed by a required Stop condition. The Stop condition can be either a programmable future time or after a programmable number of samples. If **Samples** (F2) are selected as the Stop condition, then the Data Logger can also be programmed to start either immediately (**now**), at a future period in time (**later**) or following any one of a number of external events (**condition**).

The function associated with the periodic Trigger Mode are described in Section 3. Figure 4.3 shows the sequence of parameter selection for the Periodic Mode and Fig 4.4, typical summary screen displays.

4.15.2 Data Log Record Operations (Contd...)

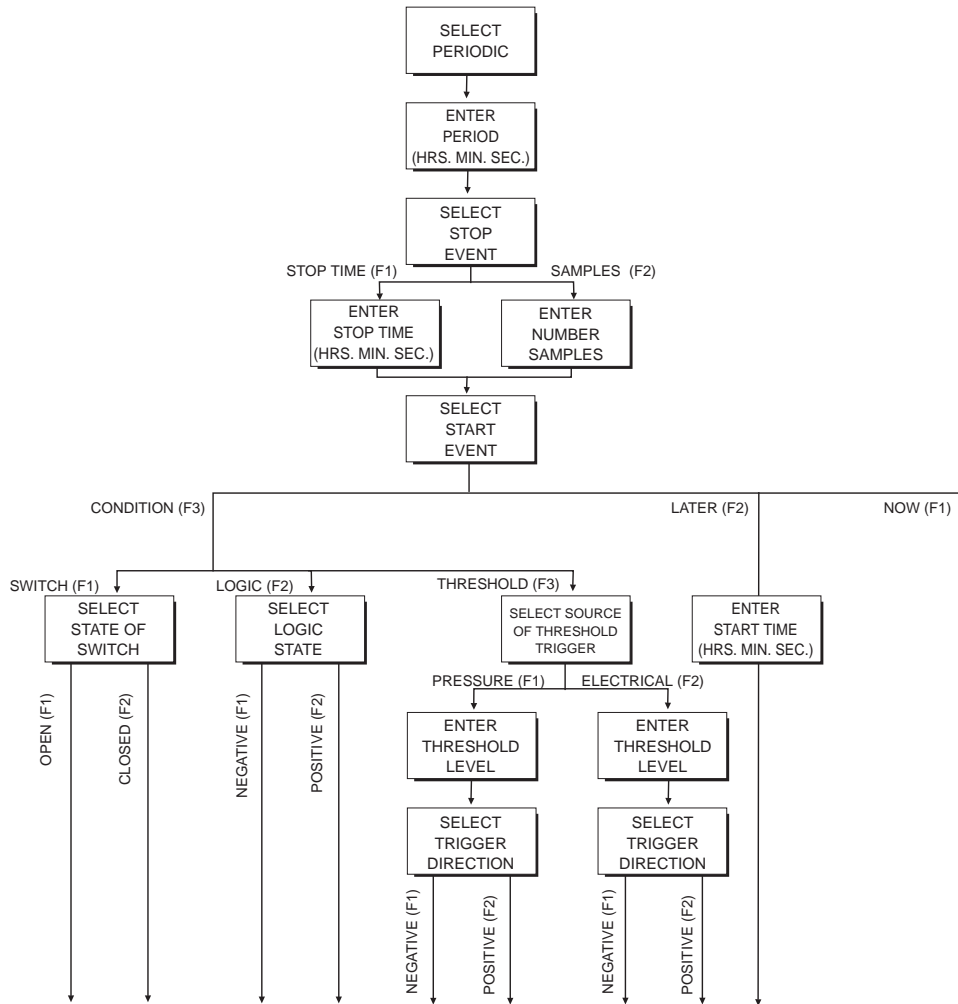

Datalog Parameters		Logging Trigger	
Start:		Logon:	
Stop:			
File ID:			
Continue			Quit

Summary Screen

Figure 4.3 - Periodic Mode

Data Log Parameters	Logging Trigger
Start: Now	Logon: Periodic time 00.00.20
Stop: 14.00	
File ID: CER01	
Continue	Quit

Example 1:

After **Continue** (F1) has been pressed, will log at 20 sec intervals from present time, terminating at 14:00.

Data Log Parameters	Logging Trigger
Start: +Threshold 10.0000 bar	Logon: Periodic time 00.00.30
Stop: 20 samples	
File ID: CER02	
Continue	Quit

Example 2:

After **Continue** (F1) has been pressed, will log at 30 sec intervals starting when pressure rises through 10 bar. Stop after 20 samples have been taken.

Data Log Parameters	Logging Trigger
Start: Switch Test Open	Logon: Periodic time 00.00.30
Stop: at 14:50	
File ID: CER03	
Continue	Quit

Example 3:

After **Continue** (F1) has been pressed, will log at 30 sec intervals, starting when switch contacts (connected between A and B) first open. Stop at 14:50 or following **Stop** command (F4) from key board.

Figure 4.4 - Typical Periodic Mode Summary Screens

4.15.2 Data Log Record Operations (Contd....)

Data Log Parameters	Logging Trigger
Start: at 14:30	Logon: Periodic time 01:00:00
Stop: 12 Samples	
File ID: CER04	
Continue	Quit

Example 4:

After **Continue** (F1) has been pressed, will log at 1 hourly intervals, commencing at 14:30. Stop after 12 Samples or following the **Stop** command (F4). Logger would usually be used with power adaptor where a protracted time scale is involved.

Data Log Parameters	Logging Trigger
Start: Logic Test -ve edge	Logon: Periodic time 00.01.00
Stop: 50 Samples	
File ID: CER05	
Continue	Quit

Example 5:

After **Continue** (F1) has been pressed, log at 1 minute intervals after a negative going logic signal (30 V max to 0V), is first applied between sockets A (+ve) and B (-ve). Stop after 50 Samples have been taken or following Stop command (F4) from key board.

Figure 4.4 - Typical Periodic Mode Summary Screens (Contd.)

DATA LOG	
● Record	
○ Replay	
○ Directory	
○ Delete	
■ Continue	
□ Quit	
△ Periodic	
▲ Event	
+ Stop Time	
+ Samples	

■ Event Mode

The **Event** trigger mode is used where Data Log operations are to be triggered by external events. Three basic event modes are provided **Now** (F1), **Later** (F2) and **Condition** (F3). A manual trigger facility is extended to the F1 function key by the **Now** option and a Data Log operation is recorded every time the **Log** key (F1) is pressed. The function is exited by pressing the **Stop** (F4) key.

A Single Shot timed operation is provided by the **Later** option (F2) and a Data Log operation is recorded at the programmed time.

The **Condition** option (F3) allows the external event trigger to be selected from either a **Switch, Logic** or **Threshold** condition. **Switch** (F1) and **Logic** (F2) provide repetitive trigger actions to the Data Logger and **Threshold** (F3) a 'One Shot' trigger i.e. the first time that a pre-programmed threshold is exceeded in either a positive or a negative direction.

Section 3.11.5, Page 3-29 details the functions associated with the **Event** trigger mode. Figure 4.5 shows the sequence of parameter selection for the Event mode and Fig 4.6, typical summary screen displays.

4.15.2 Data Log Record Operations (Contd....)

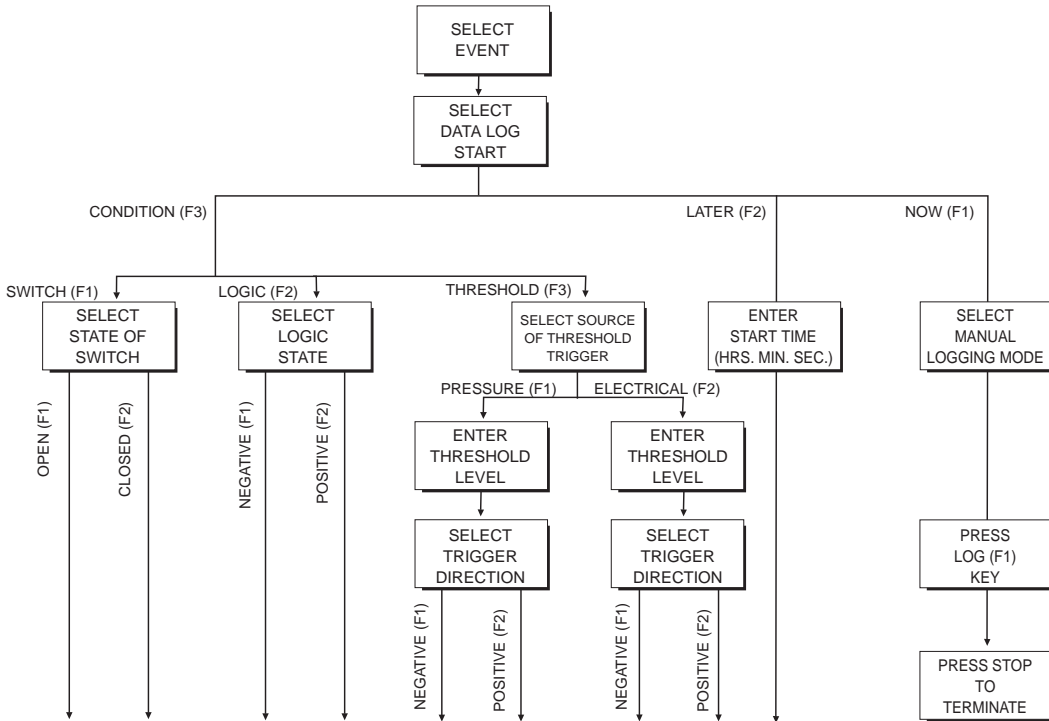

Datalog Parameters		Logging Trigger	
Start:		Logon:	
Stop:			
File ID:			
Continue			Quit

Summary Screen

Figure 4.5 - Event Mode

Test Equipment Depot - 800.517.8431 - 99 Washington Street Melrose, MA 02176

FAX 781.665.0780 - TestEquipmentDepot.com

Data Log Parameters	Logging Trigger
Start: Now	Logon: Switch Test Open
Stop: 14.00	
File ID: CER11	
Continue	Quit

Example 1:

After **Continue** (F1) has been pressed, will log every time the external switch contacts (connected between sockets A and B) open. Logging sequence is terminated by pressing the **Stop** (F4) key.

Data Log Parameters	Logging Trigger
Start: N/A	Logon: + Threshold 12.000 mA
Stop: Single Shot	
File ID: CER12	
Continue	Quit

Example 2:

After **Continue** (F1) has been pressed, will perform a single shot logging operation when the measured electrical signal rises through 12 mA. A File Closed message is displayed to indicate that the logging operation has terminated.

Data Log Parameters	Logging Trigger
Start: N/A	Logon: Login Test -ve edge
Stop: N/A	
File ID: CER13	
Continue	Quit

Example 3:

After **Continue** (F1) has been pressed, will log every time a negative going edge (applied between terminals A (+ve) and D (-ve), occurs. The logging sequence is terminated by pressing the **Stop** (F4) key.

Figure 4.6 - Typical Event Mode Summary Screens

4.15.2 Data Log Record Operations (Contd....)

Data Log Parameters	Logging Trigger
Start: at 16.00	Logon: Start
Stop: Single Shot	
File ID: CER14	
Continue	Quit

Example 4:

After **Continue** (F1) has been pressed, will perform a single shot logging operation at the programmed time (16.00). A File Closed message is then displayed to indicate that the logging operation has terminated.

Data Log Parameters	Logging Trigger
Start: N/A	Logon: - Threshold 10.2500 bar
Stop: Single Shot	
File ID: CER15	
Continue	Quit

Example 5:

After **Continue** (F1) has been pressed, will perform a single shot logging operation when the recorded pressure drops below 10.25 bar. A File Closed message is then displayed to indicate that the logging operation has terminated.

Figure 4.6 - Typical Event Mode Summary Screens (Contd.)

4.15.3 Data Log Replay Operations

To replay **Data Log** results data, select the **Replay** option (F2) from the Data Log menu.

A directory showing the first page of Data Logged files is displayed (e.g.),

File ID (Data Log)	Free Blocks: 10846	
→ AF 26123	22/02/93	9.23.40
AX 27000	22/02/93	9.56.10
AY 28000	22/02/93	11.16.20
Page Up	Page Down	↑ ↓

To replay a Data Log file, select the required file by means of the **Page Up** (F1), **Page Down** (F2), ↑ (F3) or ↓ (F4) cursor keys and press the **ENT** key on the numeric key-pad.

Four display modes are now provided as follows.

Select replay format:

Display Graph Print Upload

- **Display**

Selection of the **Display** option (F1) writes the data associated with the first location of the selected Data Log file to the display (e.g.) .

Location 1 of 20 AY28000
Previous Next 16.07.59 05/08/92

DATA LOG
○ Record
● Replay
○ Directory
○ Delete
■ Display
□ Graph
□ Print
□ Upload
△ Periodic
△ Next

To display the data relating to all subsequent locations, press the **Next** key. If an out of range location is requested, the instrument remains at the current location and flashes an error message **Number out of range**. **Previous** displays, data in the previous location. Repeated pressing of the **Previous** key causes the instrument to step back one location each time. Alternatively, a location can be directly entered via the keyboard and will be displayed when **ENT** is pressed. At the end of file, the following display is printed (e.g.).

20 of 20 End AY 28000
Previous Next 16.08.57 05/08/92

● **Graph**

Selection of the **Graph** option (F2) permits the operator to choose a graphical output of the selected Data Log file to the display. The options available are selected by the function keys F1 to F3 as follows.

- PvT [Pressure v Time] (F1)**
- EvT [Electrical v Time] (F2)**
- PvE [Pressure v Electrical] (F3)**

Selection of one of these function keys (e.g.) **PvT** (F1) will display an appropriate graph as follows (e.g.) .

Graph of Pressure V's Elapsed Time

DATA LOG	
<input type="radio"/>	Record
<input checked="" type="radio"/>	Replay
<input type="radio"/>	Directory
<input type="radio"/>	Delete
<hr/>	
<input type="checkbox"/>	Display
<input checked="" type="checkbox"/>	Graph
<input type="checkbox"/>	Print
<input type="checkbox"/>	Upload
<hr/>	
<input type="checkbox"/>	PvT
<input type="checkbox"/>	EvT
<input type="checkbox"/>	PvE

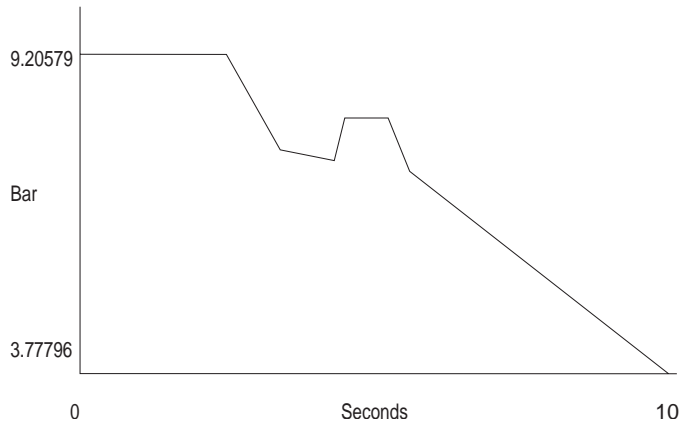

To return to the graph selection menu after displaying the required data, press **EXIT** menu.

● **Print**

DATA LOG	
<input type="radio"/>	Record
<input checked="" type="radio"/>	Replay
<input type="radio"/>	Directory
<input type="radio"/>	Delete
<hr/>	
<input type="checkbox"/>	Display
<input type="checkbox"/>	Graph
<input checked="" type="checkbox"/>	Print
<input type="checkbox"/>	Upload

Selection of the **Print** option (F3) causes all data associated with the selected replay file to be down-loaded to a printer. To make use of this option, a printer must be connected to the RS 232 interface. The instrument software supports two types of printer, a 40 column portable printer and an 80 column printer. The printer types are set-up under the **Set-up** option for **Defaults**. The instrument automatically formats the output file for the type of printer in use. A typical printout is as follows.

```

Calibration Certificate

Test Equipment

DPI 605 Serial No.  :0
DPI 605 S/W Version      :0.53
Last Cal. Date       :17.04.92
Pressure Range       :20 bar g

Device Under Test

File Identity        :2
Date                 :14/07/92
Time                 :9.55.52
Serial Number        :1234
DUT Full Scale       :20.00000
File Type            :AutoCal. File

Test Results

PRESSURE ELECT TIME
bar      Milliamps
0.61675  -0.007  9.55.53
0.59540  -0.007  9.55.56
0.54291  -0.007  9.56.00
0.51893  -0.007  9.56.03

Printed - 9.57.42  14/07/92

Authorised: _____
    
```

Note: In the event of any problems encountered, the **Print** operation can be aborted by operation of the **Exit Menu** key.

● **Upload**

DATA LOG	
<input type="radio"/>	Period
<input checked="" type="radio"/>	Replay
<input type="radio"/>	Directory
<input type="radio"/>	Delete
<hr/>	
<input type="checkbox"/>	Display
<input type="checkbox"/>	Graph
<input type="checkbox"/>	Print
<input checked="" type="checkbox"/>	Upload

Selection of **Upload** option causes all data associated with the selected **Data Log** file to be uploaded to an external system via the RS 232 port. This file is sent as ASCII text and as such is readily readable and importable into common spread-sheets such as Microsoft Excel etc. The RS 232 port is configured from the Set-up menu under the Defaults (Comms) options.

Note: In the event of any problems encountered, the **Upload** operation can be aborted by operation of the **Exit Menu** key.

4.16 Use of AutoCal Facility

The **AutoCal** option enables the instrument to automatically store the results obtained from a large number of calibration runs. The function has two basic modes of operation **Manual** and **Auto**.

The **Auto** option permits the instrument to be programmed, via the RS 232 port, to carry out tests on a number of devices. These programmed tests are used to set-up both the electrical and pressure outputs of the instrument for each test.

In the **Manual** option, the operator must manually set-up the electrical outputs and for calibrator versions of the instrument, use the hand-pump to set the required pressures. For indicator versions of the instrument, the applied pressure must be set-up externally. An **AutoCal Log** operation is then carried out every time the **AutoCal Log** key is operated.

To carry out an AutoCal operation, proceed as follows - refer to fig. 4.1.

- Open the Vent Valve (2) to ensure that the instrument is depressurised.
- Connect the device or system under test to the instrument.
- Switch the instrument ON.
- Set-up the instrument to display the required measurands.
- Press the **ZERO** key.
- Close the Vent Valve (2).
- Select the **AUTOCAL** function. Selection of this function displays the AutoCal menu as follows (e.g.),

AutoCal Menu

Test	Replay	Directory	Delete
------	--------	-----------	--------

- To obtain a listing of the **AutoCal** File names already used, press the **Directory** (F3) key. The Directory utility is described in Section 3.11.9 and the use of the utility in Section 4.15.1.

- Select **Test** (F1) from the AutoCal menu. This action provides a prompt requesting the type of AutoCal operation to be carried out (e.g.),

Select type of AutoCal

Manual **Auto**

- Select the required mode by pressing either the **Manual** (F1) or **Auto** (F2) keys. **Manual** AutoCal procedures are described in Section 4.15.2 and **Auto** AutoCal procedures in 4.15.4. Section 4.15.3 describes the method of replaying AutoCal data.

4.16.1 Use of the AutoCal Directory and Delete Utilities

- Directory Utility**

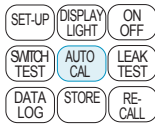

Selection of the **Directory** (F3) option from the AutoCal menu provides access to two directories, a **Tests** directory and a **Results** directory. The relevant directories are selected by the **Tests** (F1) and **Results** (F2) keys. Both directories are listed in the order in which the AutoCal operations were carried out. For **Auto** AutoCal, this means the order in which the tests were programmed and the results collected. Typical directory listings are as follows.

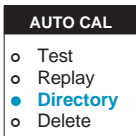

AutoCal Tests	Free Blocks 9212
→ TS15000000000000000001	N1234543670111111112
TS15000000000000000002	N1234543670111111113
TS15000000000000000008	N1234543670111111114
TS15000000000000000032	N1234543670111111115
TS15000000000000000033	N1234543670111111116

Page Up Page Down

Typical Tests Directory

AutoCal Results	Free Blocks 9212
→ TS15000000000000000001	N1234543670111111112 >1
TS15000000000000000002	N1234543670111111113 >1
TS15000000000000000008	N1234543670111111114 >1
TS15000000000000000032	N1234543670111111115 >1
TS15000000000000000033	N1234543670111111116 >1

Page Up Page Down

Typical Results Directory

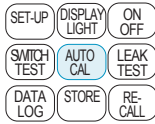

The (e.g.) **Free Blocks 9212** legend gives an indication of remaining memory space and the first five entries in the directory are displayed. The **Page Up** and **Page Down** functions, allocated to the F1 and F2 keys respectively, provide a means of scrolling forward (**Page Down**) or back (**Page Up**) through the directory listing. The **Exit Menu** key is used to return to the main AutoCal menu. When first entering the AutoCal function, it is good practice to interrogate the directory. This will enable the operator to determine what file ID numbers have already been used, since an attempt to use an existing file ID number to record an operation will result in the display of an error message - **File already exists**.

The >1 symbol in the results directory indicates the result obtained from a first test. A >2 symbol indicates the results of the last test on a device.

● **Delete Utility**

This AutoCal function enables files to be deleted from the AutoCal memory. Selection of the AutoCal Delete function initially provides the option to delete files located in either the **Tests** directory or the **Results** directory. The appropriate directory is selected by means of either the **Tests** (F1) or **Results** (F2) keys. Selection of one of these directories produces the appropriate directory listing, typical listings are shown below.

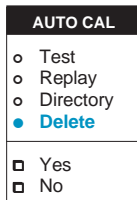

AutoCal Tests	Free Blocks 9212
→ TS150000000000000001	N123454367011111112
TS150000000000000002	N123454367011111113
TS150000000000000008	N123454367011111114
TS150000000000000032	N123454367011111115
TS150000000000000033	N123454367011111116
Page Up	Page Down ↑ ↓

Typical Tests Directory

AutoCal Results	Free Blocks 9212
→ TS150000000000000001	N123454367011111112 >1
TS150000000000000002	N123454367011111113 >1
TS150000000000000008	N123454367011111114 >1
TS150000000000000032	N123454367011111115 >1
TS150000000000000033	N123454367011111116 >1
Page Up	Page Down ↑ ↓

Typical Results Directory

Use the **Page Up** and **Page Down** keys to select the appropriate directory page and the ↑ and ↓ keys to select the file on the relevant page.

To delete a selected file, position the cursor against the file name and press the **ENT** key on the numeric key-pad. Providing the file is not password protected, a pre-delete warning is displayed as follows.

Delete - Are you Sure?

Yes **No**

The file is deleted on subsequent operation of the **Yes** (F3) key or the Delete operation aborted by operation of the **No** (F4) key.

If a file is password protected, following operation of the **Yes** (F3) key, a prompt is given for the corresponding password as follows.

Enter File Protection Number

Enter the password (a number within the range 1 to 9999) followed by **ENT**. The file is then deleted. It should be noted that if a Tests file is password protected, then the corresponding Results file will also be protected by the same password.

4.16.2 AutoCal Manual Operations

To carry out an AutoCal Manual operation, proceed as follows,

AUTO CAL	
●	Test
○	Replay
○	Directory
○	Delete
■	Manual
□	Auto
△	Yes
△	Dial Gauge
◇	AutoCal Log
◇	Stop

- Select **Test** (F1) from the AutoCal menu. A prompt to select either **Manual** or **Auto** is then displayed (e.g.),

Select type of AutoCal

Manual **Auto**

- Select **Manual** (F1). A prompt to log either the current display **Yes** (F1) or to have the facility of manually entering a **Dial Gauge** reading (F2) against the Pressure display is given as follows (e.g.),

Log current display

Yes **Dial Gauge**

Selection of **Yes** (F1) causes Pressure/Electrical measurements to be recorded. Selection of **Dial Gauge** (F2) permits the manual entry of a pressure level to be recorded against the corresponding instrument pressure reading.

- A request for a File ID is now presented as follows (e.g.),

Enter File ID:

Alpha ↑ **Alpha** ↓ ← →

This file number can be either alphabetical, numerical or a combination of both. Alpha character are entered by means of the **Alpha** ↑ (F1), **Alpha** ↓ (F2), ← (F3) and → (F4) keys. **Alpha** ↑ (F1) scrolls forward through the alphabet and **Alpha** ↓ (F2) backwards. Shifting right to the next character position or left to a previous character position is achieved by the → (F4) and ← (F3) keys respectively. Numeric entries are added directly from the numeric key-pad. The full alpha numeric text is added to the file by pressing the **ENT** key.

- Following entry of the file ID, the instrument prompts for a **transducer serial number** (Alpha-numeric) followed by the full scale deflection (FSD) of the transducer under test and the type of transducer (**Absolute, Gauge** or **Differential**). The instrument then enters the logging mode.

An example of a typical dialogue sequence is shown below. After each prompt, the relevant numerical figures should be entered on the keyboard followed by **ENT** (e.g.).

```
ID number: AST 471
Transducer SN: <CER 162>
Enter FSD of transducer:<5>
Transducer Type: F2 (Gauge)
```

After completion of data entry, the pressure calibration tests on the device under test are carried out and at each pressure, the instrument will record all the measured parameters currently on the display, every time the **AutoCal Log** key (F1) is pressed.

- Using the Hand-pump (calibrator versions) or by external pressure control (indicator versions) increase the system pressure until the first calibration pressure is obtained. Use the volume adjuster (calibrator only) to obtain the exact value required.
- If using the Dial Gauge option, enter the dial gauge reading on the numeric key-pad and press **ENT**.

- Record all measured parameters at this calibration pressure by pressing the **AutoCal Log** key (F1).
- Using the Hand-pump (calibrator versions) or by external pressure control (indicator versions) increase the system pressure until the next calibration pressure is obtained entering dial gauge reading (if selected), at each new pressure. Press the **AutoCal Log** key (F1) to store the data.
- Repeat until all the required calibration pressures have been logged. At each way point, the number of points taken during the calibration run is indicated on the display (e.g.),

Manual AutoCal 12	8.35.40	28/02/93
AutoCal Log		Stop

- To terminate the logging sequence, press the **Stop** (F4) key.

After completion of the logging sequence, three options for analysing the results are available. These are **Best Straight Line** (BSL), selected by F1, and **Terminal Straight Line**, selected by F2 and **Absolute Straight Line** (ABS), selected by F3. For each function, the maximum deviation from the straight line is obtained by pressing the **Results** (F2) key. The electrical offset and gradient of the straight line are obtained by pressing the **Details** (F1) key.

- To exit the **Manual AutoCal** mode, press the **Exit** key (F4) at the Analyse results prompt (e.g.),

Analyse results:

BSL	TSL	ABS	Exit
------------	------------	------------	-------------

- To replay the results obtained, refer to Section 4.15.3.

4.16.3 Replay of AutoCal Log Files

To replay an AutoCal file, proceed as follows.

- Select **Replay** (F2) from the AutoCal Menu.

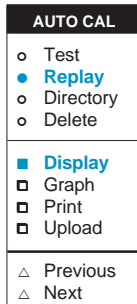

A directory showing the first page of Data Logged files is displayed (e.g.),

AutoCal Results		Free Blocks 9212
→	TS15000000000000000001	N1234543670111111112 >1
	TS15000000000000000002	N1234543670111111113 >1
	TS15000000000000000008	N1234543670111111114 >1
	TS15000000000000000032	N1234543670111111115 >1
	TS15000000000000000033	N1234543670111111116 >1

Page Up Page Down

To replay a Data Log file, select the required file by means of the **Page Up** (F1), **Page Down** (F2), ↑ (F3) or ↓ (F4) cursor keys and press the **ENT** key on the numeric key-pad.

Four display modes are now provided as follows,

Select replay format:

Display Graph Print Upload

■ **Display**

Selection of the **Display** option (F1) writes the data associated with the first location of the selected Auto Cal log file to the display (e.g.) .

1 of 20 AY 28000

Previous Next 16.07.59 28.02.93

To display the data relating to all subsequent locations, press the **Next** key. Alternatively, enter the required location directly from the keyboard and press **ENT**. If an out of range location is requested, the instrument remains at the current location and flashes an error message **Number out of range**. **Previous** displays, previous data. Repeated pressing

of the **Previous** key causes the instrument to step back one location each time. Alternatively, a location can be directly entered via the keyboard and will be displayed when **ENT** is pressed. At the end of file, the following display is printed (e.g.).

Location 20 of 20 AY 28000

Previous Next 16.08.57 25/02/93

■ **Graph**

AUTO CAL	
<input type="radio"/>	Test
<input checked="" type="radio"/>	Replay
<input type="radio"/>	Directory
<input type="radio"/>	Delete
<hr/>	
<input type="checkbox"/>	Display
<input checked="" type="checkbox"/>	Graph
<input type="checkbox"/>	Print
<input type="checkbox"/>	Upload
<hr/>	
<input type="checkbox"/>	Previous
<input type="checkbox"/>	Next

Selection of the **Graph** option (F2) permits the operator to choose a graphical output of the selected Auto Cal log file to the display. The options available are selected by the function keys F1 to F3 as follows.

P Points E Points PvE

These options are **Pressure v Points** (F1), **Electrical v Points** (F2) and **Pressure v Electrical** (F3).

Selection of one of these function keys (e.g.) **PvT** (F1) will display the appropriate graph as follows.

Graph of Pressure Points Recorded

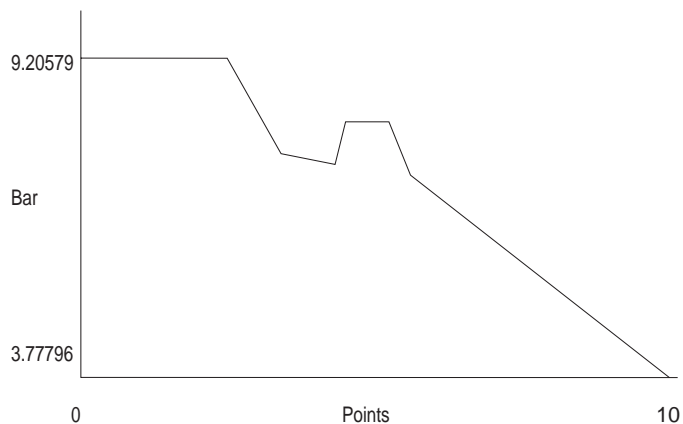

To return to the graph selection menu after displaying the required data, press **Exit Menu**.

4.15.3 Replay of AutoCal Log Files (Contd....)

Note that if the **Dial Gauge** display option was selected for the test under review, E Points gives a graphic output of **Dial I/P v Points** and **PvE, Pressure I/P v Dial Gauge** reading.

■ Print

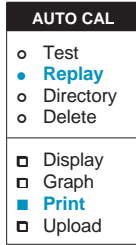

Selection of the **Print** option (F3) causes all data associated with the selected replay file to be downloaded to a printer. To make use of this option, a printer must be connected to the RS 232 interface. The instrument software supports two types of printer, a 40 column portable printer and an 80 column printer. The printer types are set-up under the **Set-up** option for **Defaults**, see Section 3.11.3. The instrument automatically formats the output file for the type of printer in use. A typical printout is shown below.

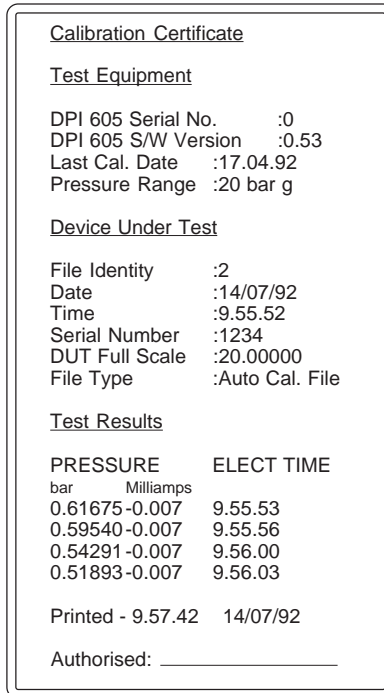

■ Upload

Selection of **Upload** option (F4) causes all data associated with the selected **AutoCal** file to be uploaded to an external system via the RS 232 port. The file is transmitted as ASCII text and as such is readily readable and imported into common spread-sheets such as Microsoft Excel etc. To use the facility, proceed as follows,

- Ensure that the RS 232 port is set-up to the requirements of the external system (refer to Set-up Section 4.5.3.).
- Connect the external system to the instrument RS 232 output socket located on the right hand side panel.

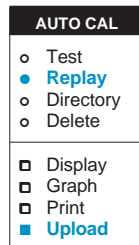

- Select **AUTOCAL**.
- Select **Replay** option (F2) from AutoCal menu and select file to upload.
- Press **Upload** (F4). The corresponding file will now be uploaded to the external system.

4.16.4 Auto AutoCal Procedures

In the Auto AutoCal mode of operation, the user selects a test program which has been downloaded into the instrument via the RS 232 port. Test programs are created external to the instrument on a computer by means of a software tool such as Druck's **InteCal** and **DPI 605 File Manager**. Specific details regarding the building of Test Files are described in Appendix A.

To download a file into the instrument, proceed as follows.

- Connect the instrument to the external computer system by means of the RS 232 adaptor lead.
- Switch the instrument ON.
- Check that the instrument's RS 232 port is set-up to match that of the external system. Communications parameters are configured in the Set-up Mode (Refer to Section 4.5.3).

- Transmit the test file to the DPI 605 instrument.

NOTE: The instrument should not be in the Data Log or AutoCal mode when the data transmission is carried out. When a file has been successfully transferred, the File ID is displayed on the display dialogue line and the file is then available for selection from the AutoCal Tests directory.

To carry out a specific AutoCal test, proceed as follows.

- Select **AUTOCAL**.
- Select **Test** (F1) option from the AutoCal menu.
- Select **Auto** (F2). Selection of Auto displays a Test Menu on the screen (e.g.)

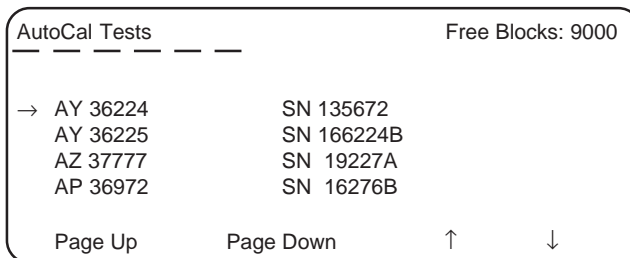

- Select the required test file by means of the **Page Up** (F1), **Page Down** (F2), **↑** (F3) and **↓** (F4) keys and press **ENT**.
- Follow the instructions given on the display, setting up pressures and logging results as requested.

To replay AutoCal log files, refer to Section 4.15.3.

4.17 Use of the RS 232 Port

The instrument is provided with an RS 232 port for the transfer of data to and from the instrument.

The RS 232 port is completely floating with respect to the instruments' electronics, therefore no "earth loop" problems should be encountered.

In the event of any data communication problems being encountered, press the **Exit Menu** key to abort the current operation.

- **Connection to a Printer**

The optional printer for the DPI 605 is a 40 column battery portable device. It is typically used for obtaining "hard copy" of test results or data logged files. The printer is supplied complete with a lead to connect it to the instrument's RS 232 port.

If the instrument's RS 232 port is to be used for connection to the optional printer then the following RS 232 parameters must be set. (All are to be found under the **SET-UP, Comms** function, full details of the use of the comms port SET-UP is given in Section 4.5.3).

Baud Rate	9600
Parity	None
Handshaking	Both

Also under **SET-UP, Defaults, Printer** the DRUCK 40 COL. Printer must be selected.

A standard 80 column printer may be used, 80 column should be selected under **SET-UP, Defaults, Printer** and the parameters of the RS 232 port must be configured to suit the particular printer in use.

What ever printer is used, printing is initiated by key press from within the operating modes of the instrument which facilitate the printing out of files of results, (e.g.) **Data Log** and **AutoCal**.

- **Connection to a Computer**

The instrument may be connected to a computer via its RS 232 port for the purpose of transferring files of test results from Data Log or AutoCal functions to the computer. A lead is supplied with the instrument which functions as an adaptor between the 6 pin Lemo connector on the instrument and the industry standard 9 pin D type connector commonly found modern computers. Prior to connecting the instrument to a computer the parameters of the RS 232 port should be set to match those of the computer, (e.g.) baud rate, parity, handshaking.

Once the connection has been established, two possible techniques for gathering files from the instrument are available.

- **Upload**

If the communication channel into the computer can be “held open” i.e. computer waiting to receive data, then use of the Upload feature to be found in the Data Log and AutoCal modes will cause a file of data to be sent from the instrument. The file is sent as ASCII text and as such is readily readable and importable into common spread sheets such as Microsoft Excel.

Full details of the use of Upload can be found in the Section of this manual detailing the Data Log and AutoCal modes of the instrument (Sections 4.14 and 4.15).

- **Dialogue**

The communications dialogue between the DPI 605 instrument and an external system is carried out over the RS 232 interface using the SCPI protocol. Appendix B of this handbook details the SCPI protocol and command structure.

Figure 4.8 - RS 232 Pin-out

4.18 Memory Reset Option

The memory used for storage of Data Log and AutoCal Results files is non-volatile and is very resistant to corruption, many precautions against corruption having been incorporated within the design of the instrument.

However, under exceptional circumstances, an example of which is rapid unexpected loss of power during data Logging, (but not use of the **ON/OFF** key), may cause corruption of the Results file being created at the time.

The nature of the corruption varies and in rare circumstances it may be necessary to "reset" the instrument's memory. This in no way affects calibration or other parameters.

CAUTION: THE FOLLOWING PROCEDURE WILL ERASE ALL DATA STORED IN THE INSTRUMENT'S MEMORY.

To reset the instrument's memory, proceed as follows.

- Press the **SET-UP** key.
- Select **Cal/Test** (F4) from the Set-up Menu.
- Enter PIN number **13760** and press the **DATA LOG** key. A prompt will now be displayed as follows (e.g.).

All logged data will be lost?

Yes

NOTE: If the **Yes** (F1) function key is pressed, all data stored in the instrument's memory will be deleted.

- To reset the memory, press the **Yes** (F1) key, otherwise, press **Exit Menu**.

4.19 De-contamination Procedures

The DPI 605 instrument is designed to operate by gas compression. Filters are provided in all the inlets and outlets to prevent the ingress of particulate matter.

Every care should be taken to prevent the ingress of fluids (particularly when using the instrument for vacuum applications). In applications where there is a high risk, of fluid ingestion, it is advisable to fit an in-line liquid separator trap between the external system and the instrument.

Should the instrument become contaminated with fluid, proceed as follows (refer to Fig. 4.1).

- Open the Vent Valve (2) and disconnect any connections to the Pressure Port (5).
- Ensure that the instrument is set to Pressure mode (NOT Vacuum mode).
- Switch the instrument OFF.
- Screw the Volume Adjuster (4) fully in (minimum volume) and close the Vent Valve (2).
- Invert the instrument and pump out as much contaminant as possible from the Pressure Port.
- Using a screwdriver, remove the filter from the Pressure Port (5) and the Vent Port (1) (**do not remove the filter in the Breather Port**).
- Seal the pressure port with a suitable blanking plug and pump up the pressure in the instrument to approximately 20 bar. Open the Vent Valve (2) and the contaminant will be blown out through the Vent Port (3). Repeat a number of times until no further contaminant is seen to be blown out.

- Remove the base of the instrument and check that no bubbles of fluid remain in the pipelines.
- Refit filters to the pressure and vent ports and check instrument's reading against a known standard.

4.19.1 Flushing the Instrument's Pneumatic System

In extreme circumstances where the procedure outlined in Section 4.18 does not cure the problem, the instrument's pneumatic system can be flushed out with clean or soapy water. To flush the pneumatic system, proceed as follows - refer to Fig. 4.1.

- Using a screwdriver, remove the filter from the Pressure Port (5) and Vent Port (2) respectively.
- Connect a clean tube to the Breather Port (7) via a G $\frac{1}{8}$ adaptor.
- Switch the instrument on and set it up to Pressure mode (NOT Vacuum mode).
- Place the open end of the tube connected to the breather port into a beaker of water or soapy water as appropriate and operate the Hand-pump (3) to suck the cleaning agent into the instrument's pipe-work.
- Remove the connection to Breather Port (7). Repeat the procedure outlined in Section 4.19.

If the procedures outlined in Sections 4.19 and 4.19.1 fail to remove contamination, the instrument will need to be dismantled, this procedure being outside the scope of this document. Please consult the instrument supplier.

5.0 APPLICATIONS

The DPI 605 can be used in a number of ways to carry out calibration tests on many types of pressure devices. The instrument can generate and monitor both pressures and electrical voltages.

5.1 Form of Test

Generally, devices to be calibrated require one of the following.

- An electrical input to generate a pressure output.
- A pressure input to generate an electrical output.
- An electrical input to produce a pressure display.
- A pressure input to produce a pressure output.

For a specific type of test, the connection to the device will depend upon the device under test.

For all types of device, the calibration set-up between the DPI 605 and the device is as follows.

- Ensure that the vent valve on the instrument is open.
- Make the pressure connection between the instrument and the device under test.
- Make the electrical connections between the instrument and the device under test. Use only the recommended 4mm plug connections to connect to the instrument.
- Switch the instrument to ON by means of the **ON/OFF** key.
- Set-up **Alarm** and **Safety Limits** required for the protection of the device under test.
- Program either Programmable Output (**Prog. output**) or the Analogue Output (**Ana. output**) of the instrument to give the required output and enable the output (refer to Section 5).
- If required, connect the DMM inputs to the device under test.
- Carry out the test.

Table 5.1 details some of the types of test that can be carried out with the DPI 605. The figure number quoted in the table refers to a drawing which shows the corresponding connections to the instrument.

Device Under Test (DUT)	Connection Diagram	
	Calibrator	Indicator
Pressure to Voltage	5.1	5.10
Pressure to Voltage (External)	5.2	5.11
Pressure to Current	5.3	5.12
Voltage to Pressure	5.4	5.13
Current to Pressure (current sourcing)	5.5	5.14
Pressure Switch Test	5.6	5.15
Display Test (current sinking)	5.7	5.16
Display Test (current sourcing)	5.8	5.17
Data Log - Trigger Input	5.9	5.18

Table 5.1 - Typical Calibration Configurations

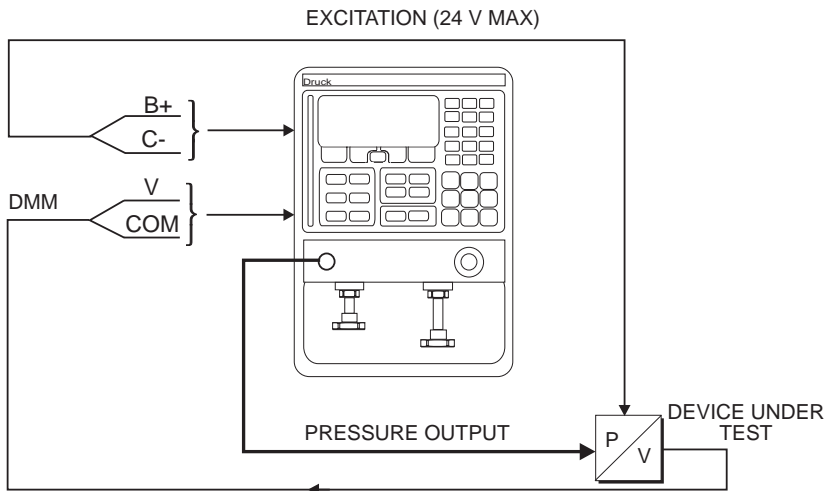

Figure 5.1 - Pressure to Voltage Transducer Calibration

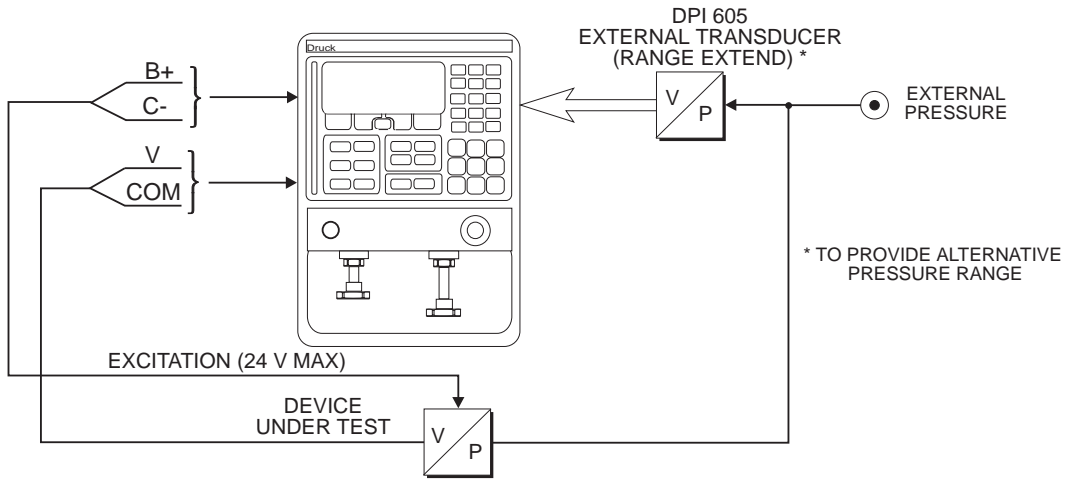

Figure 5.2 - Pressure to Voltage Transducer Calibration (External range)

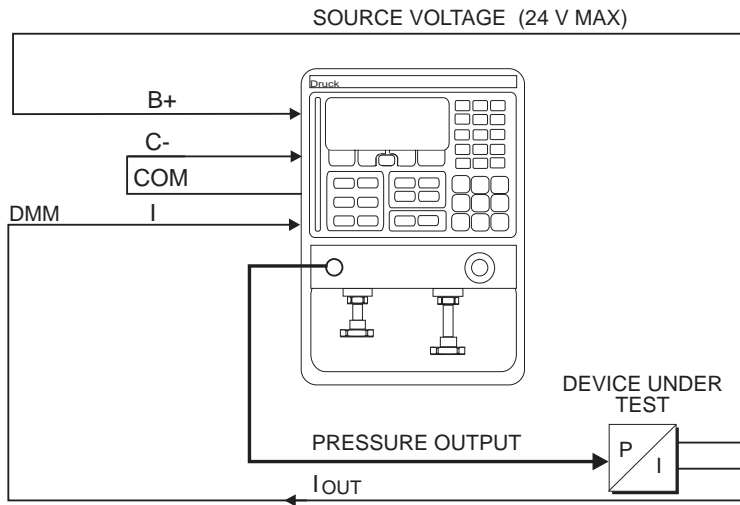

Figure 5.3 - Pressure to Current Transducer Calibration

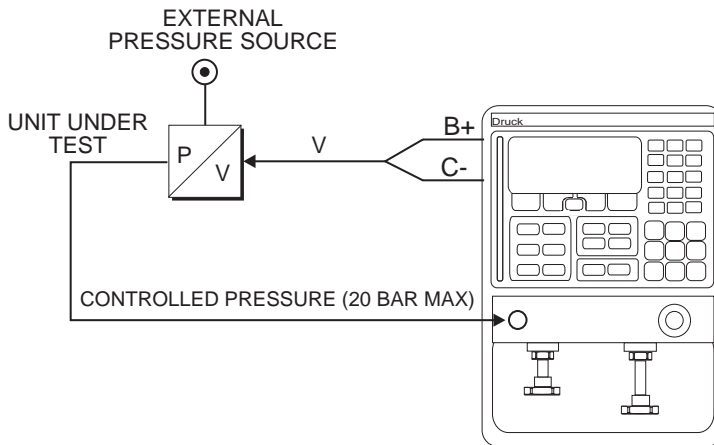

Figure 5.4 - Voltage to Pressure Transducer Calibration

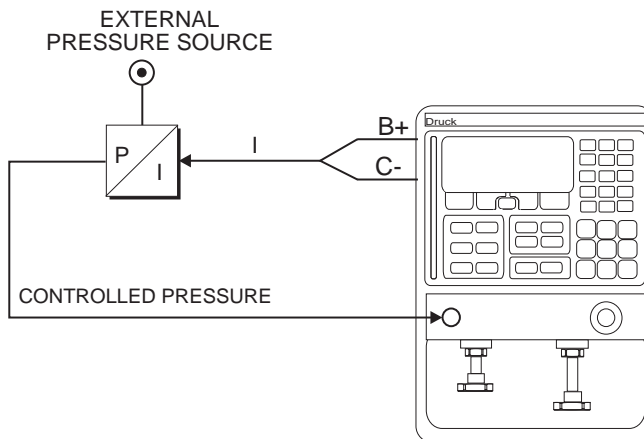

Figure 5.5 - Current to Pressure Transducer (current sourcing)

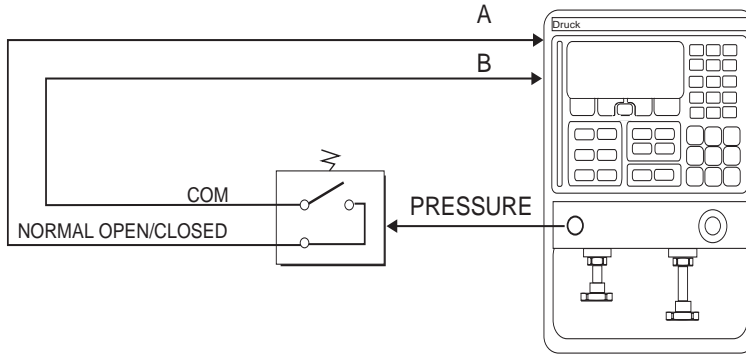

Figure 5.6 - Pressure Switch Test

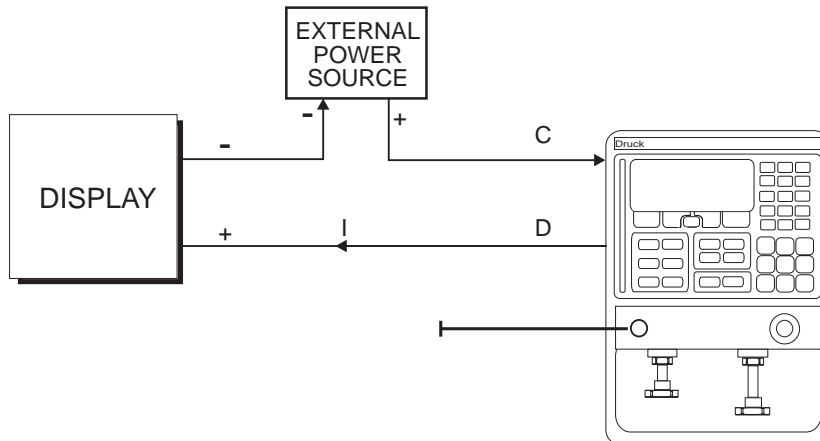

Figure 5.7 - Current Loop Display Test (current sinking)

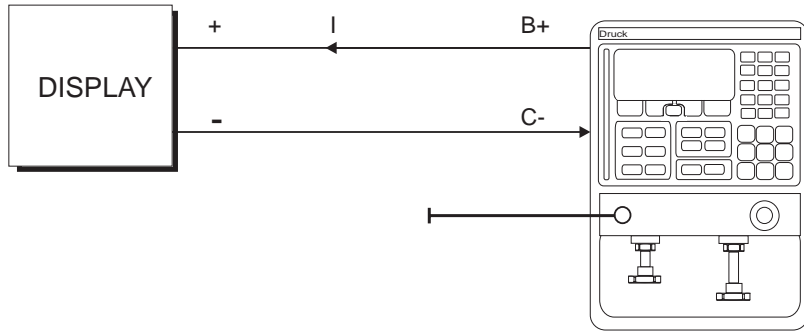

Figure 5.8 - Current Loop Display Test (current sourcing)

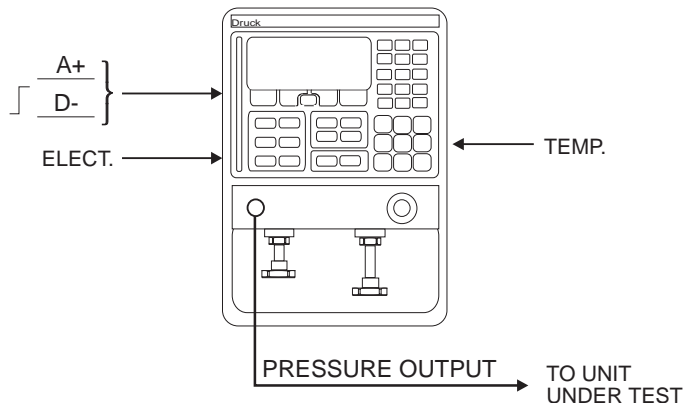

Figure 5.9 - Data Logger (external trigger)

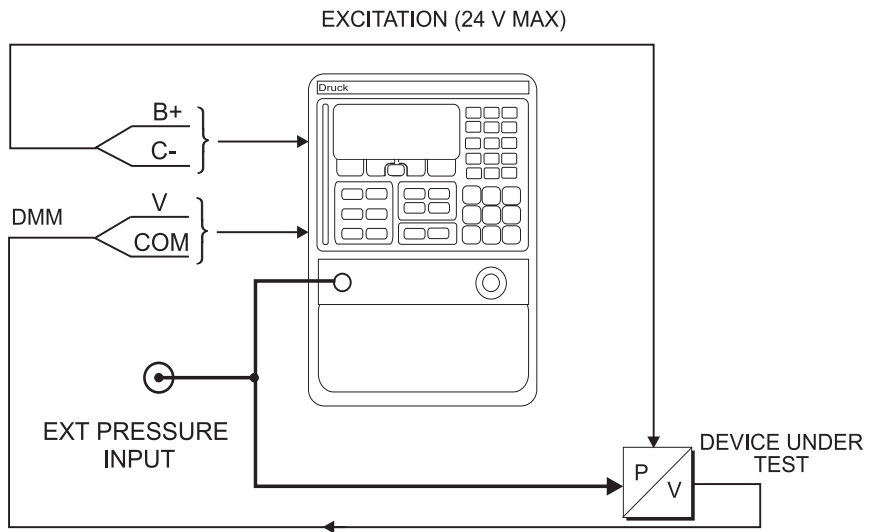

Figure 5.10 - Pressure to Voltage Transducer Calibration (Indicator)

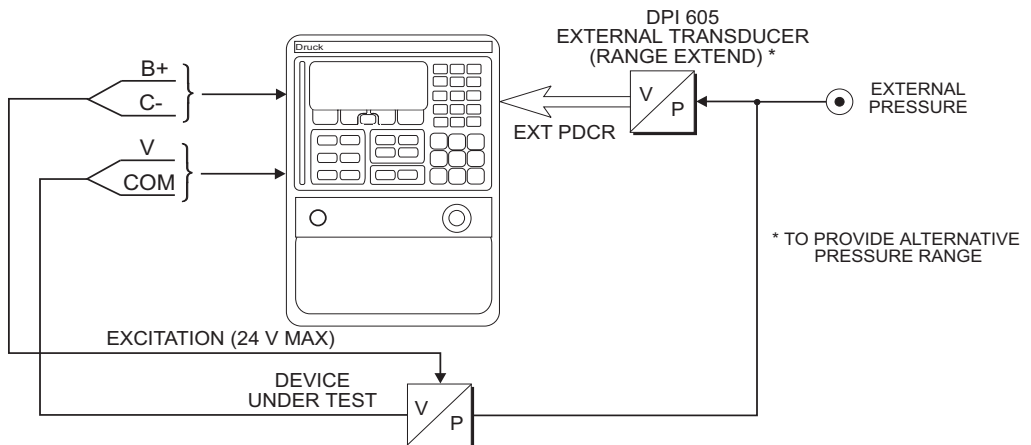

Figure 5.11 - Pressure to Voltage Transducer Calibration (Using Ext Range)

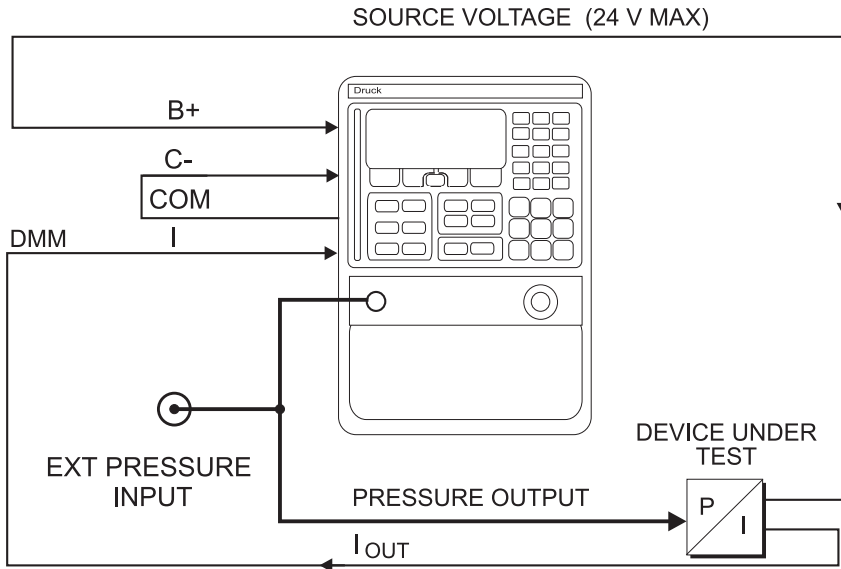

Figure 5.12- Pressure to Current transmitter Calibration (Indicator)

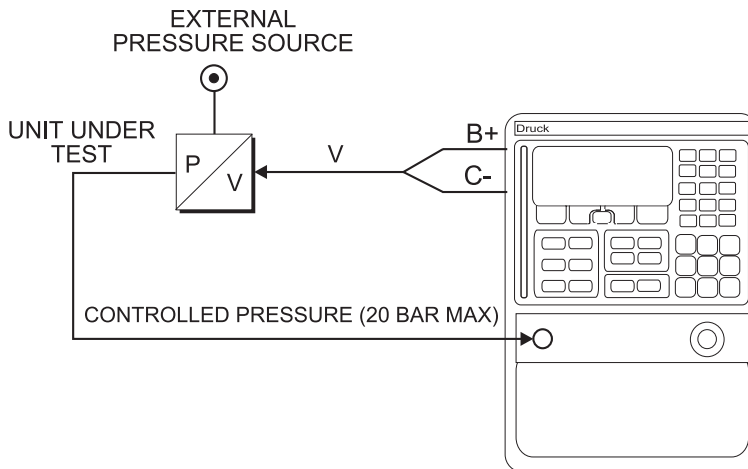

Figure 5.13 - Voltage to Pressure Transducer Calibration (Indicator)

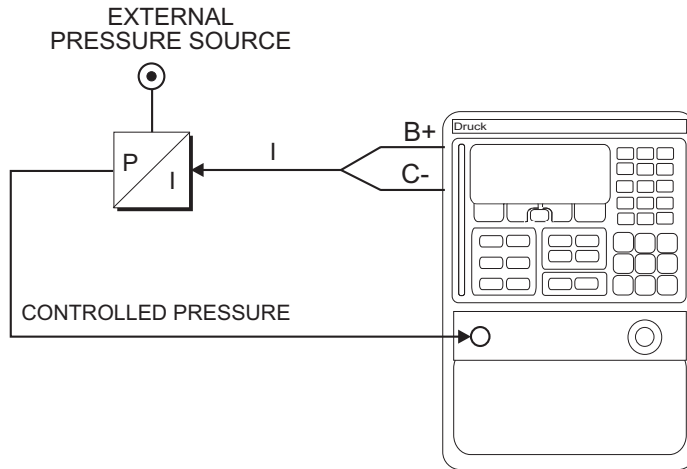

Figure 5.14 - Current to Pressure (Current Sourcing)

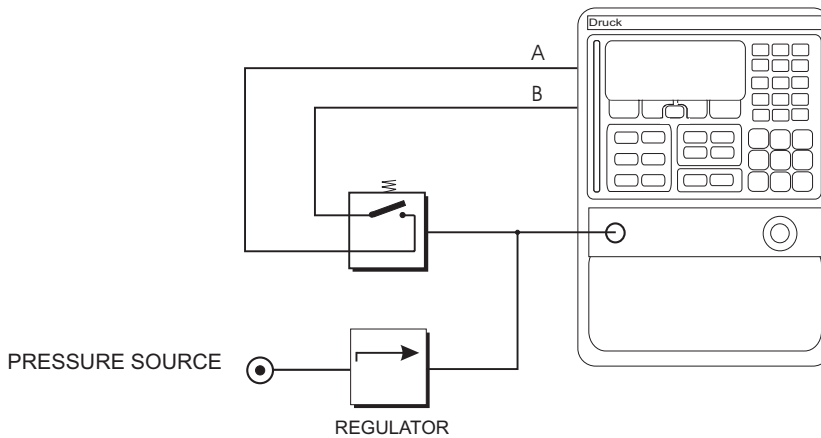

Figure 5.15 - Pressure Switch Test

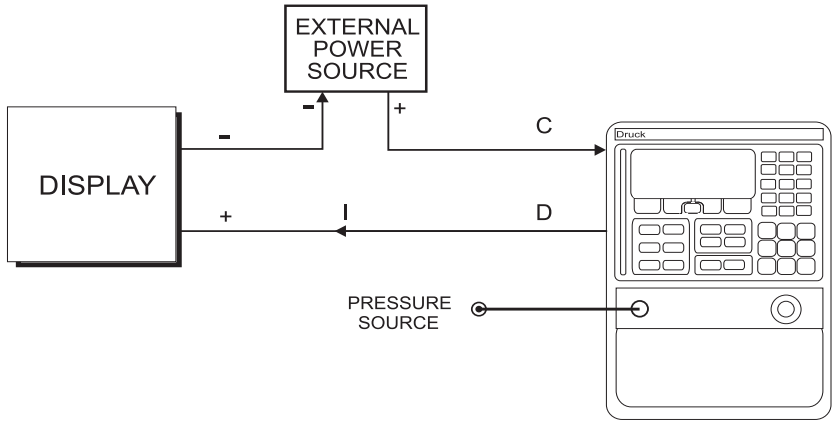

Figure 5.16 - Current to Pressure (Current Sinking)

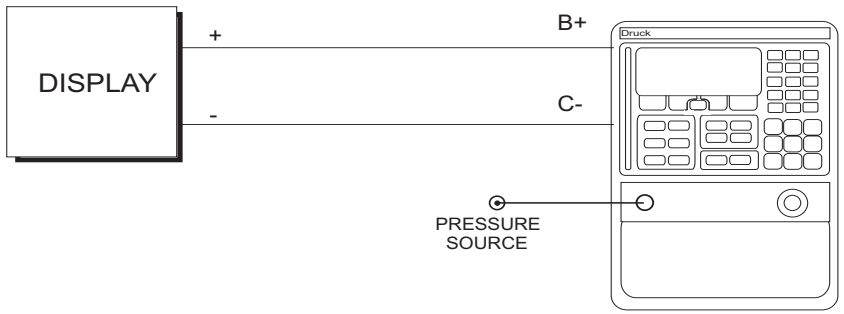

Figure 5.17 - Current to Pressure (Current Sourcing)

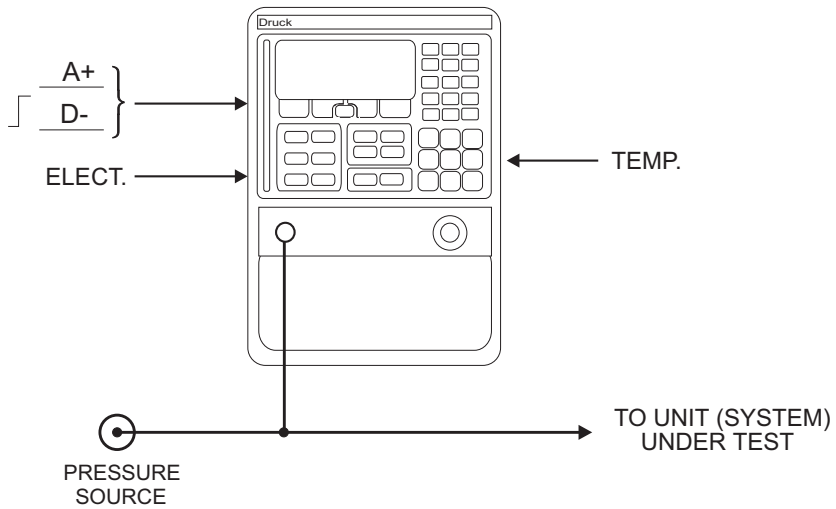

Figure 5.18 - Data Logger (External Trigger)

6 CALIBRATION

The DPI 605 instrument is supplied calibrated, together with its own individual calibration certificates. During the normal course of operation, the instrument does not need to be calibrated and so the built-in calibration routines are protected by a programmable identification number (P.I.N.).

● Selection of Calibration Routines

The calibration routines are entered via an option of the **SET-UP** facility **Cal/Test** (F4). To select the calibration mode, proceed as follows.

- Switch the instrument ON.
- Press the **SET-UP** key.
- Select **Cal/Test** (F4) from the **SET-UP** menu.

The instrument will now prompt for the entry of a PIN number. A typical prompt is shown below.

NOTE: If there is a long delay between the request prompt and entry of the PIN number, the display will "time out" and Set-up will then need to be re-selected.

Cal/Test-Enter pin Number:

Enter the correct P.I.N. number and press **ENT**. Initially, the instrument is supplied with P.I.N. number 123 installed. At the **Enter Pin Number** prompt, enter the P.I.N. number to gain access to the user Cal/Test menu as follows.

User Cal/Test Menu

Cal	Test	New Pin	Keyboard
F1	F2	F3	F4

These three options **Cal** (F1), **Test** (F2) and **New Pin** (F3) provide access to the instrument's calibration **Cal**, **Test** and selection of a new P.I.N. number (new Pin) routines.

CAUTION: IT SHOULD BE NOTED THAT THE FACILITIES UNDER THE TEST (F2) KEY ARE POWERFUL FAULT FINDING AIDS. MISUSE OF THE FACILITIES WILL CAUSE SERIOUS DAMAGE TO THE INSTRUMENT. THEY SHOULD, THEREFORE, ONLY BE USED BY TRAINED SERVICE PERSONNEL.

6.1 Selection of New P.I.N. Number

Access to all the calibration and test routines are protected by a P.I.N. number. Initially, on delivery, P.I.N. number 123 is installed.

The P.I.N. number can be changed, by the **New Pin** option of the user Cal/Test menu. To change a P.I.N. number, proceed as follows.

- Switch the instrument ON.
- Press the **SET-UP** key.
- Select **Cal/Test** from the Set-up menu by pressing the F4 function key.
- Enter the existing P.I.N. number and press **ENT**.
- Select **New Pin** from the user Cal/Test menu by pressing the F3 function key. The instrument now prompts for a new P.I.N. number, a typical dialogue being shown below. The numbers shown in brackets (e.g.) <27> represent keyboard entries made by the operator, followed by operation of the ENT key located on the numerical keyboard.

Enter new P.I.N. number<27>

Enter on its own is no P.I.N.

On entry of the required P.I.N. number, the instrument requests verification of the new pin number prior to setting it. Enter the required new Pin number in response to the following prompt (e.g.)

Verify new P.I.N. number <27>

The same P.I.N. number is entered again and providing the verification P.I.N. number agrees with the requested new P.I.N. number, the instrument accepts the new number giving the message.

Verification OK

If the entered P.I.N. number does not match the required new P.I.N. number, no new P.I.N. number will be set and an error message is displayed as follows.

Pin number does not agree

The instrument then exits from the **SET-UP** mode.

6.2 Instrument Calibration - Pressure

Calibration procedures must be carried out in a controlled environment (e.g.) Standards Laboratory.

To carry-out a pressure calibration, proceed as follows.

- Switch the instrument ON

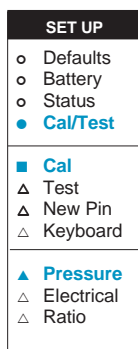

- Press the **SET-UP** key and select **Cal/Test** (F4) from the Set-up menu.
- Enter P.I.N. number and press **ENT**. This will cause the calibration adjustment menu to be displayed (e.g.).

Within the calibration adjustment menu, four options are available.

Calibration adjustment menu

Pressure	Electrical	Ratio	Keyboard
F1	F2	F3	F4

Pressure (F1), **Electrical** (F2) and **Ratio** (F3) options provide facilities for adjusting the calibration of all the measurement ranges within the instrument.

Note:

The instrument can be fitted with an internal CAL LINK. If this link is fitted, the instrument's calibration is protected. Subsequent selection of either Pressure (F1) Electrical (F2) or Ratio (F3) will result in the display of a status message and access to that function will be denied (e.g.),

Cal Disabled - Please Remove Cal Link

When fitted, the Cal Link may be sealed by a Quality Assurance seal, which, if broken, invalidates the instrument's calibration.

- The **Pressure** (F1) option provides access to the calibration adjustment of the pressure ranges of the instrument. The ranges are internal, (made up of Internal 1, used by the instrument to measure pressures in the range 2 to 20 bar and Internal 2 used by the instrument to measure pressures from -1 to 2 bar), Barometer (if the option is fitted) and External.

For **Internal 1**, **Internal 2** and **External**, three types of adjustment are possible.

- **Linearity**

Used to provide linearity correction of the pressure reading. A minimum of 5 points must be entered over the appropriate pressure range (e.g.) -1 to 2 bar for **Internal 2**. The procedure takes the form of applying precisely known pressures and entering the pressures via the key-pad. In the case of **Internal 1** or, **Internal 2**. Positive pressures are applied to the instrument's pressure port and negative pressures for **Internal 2** are simulated by application of a positive pressure to the Reference port.

- **Temperature Compensation (TC)**

Used to provide temperature compensation of the pressure reading. The temperature compensation procedure takes the form of applying zero and nominal full scale pressure to the transducer to be compensated and entering the precise value of the nominal full scale pressure applied via the key-pad. This procedure is repeated at a minimum of four different temperatures over the temperature range of interest.

- **2 Point**

This is a simple span and zero calibration adjustment. Zero pressure and nominal full scale pressure are applied to the transducer to be adjusted, the exact value of full scale pressure applied being typed in via the key-pad. This procedure leaves the linearity and temperature compensation data unchanged.

Under the Barometric option of the Pressure Calibration Adjustment menu, four further options are provided. Because the Barometric transducer works on a resonant principle, which is completely different to the piezo resistive transducers used for the other pressure ranges of the instrument, the calibration adjustment features for the Barometric option are different to those for the other ranges.

The four options are.

- **Constants**

This function provides access to the calibration constants of the Barometric transducer. The constants are derived at the time of manufacture of the transducer and should **NEVER** be altered in any way without reference to the manufacturer.

■ Frequency

This function is used to set-up the internal reference frequency of the instrument. The procedure takes the form of measuring the reference frequency (nominally 10MHz) to be found on the main printed circuit board connector PL14 pin 2 (signal) pin 3 (ground) and entering its value via the key-pad.

■ Diode

The function is used to set-up the measurement of the Barometric transducer diode voltage output. The procedure takes the form of measuring the actual diode voltage output from the Barometric transducer and entering its value via the key-pad. (The voltage is to be found on the main printed circuit board connector PL16 pin 1 (positive) and pin 2 (negative).

■ 1 Point

This function provides the ability to make a single “offset” style correction to the indicated barometric pressure. The procedure is simply to enter the accurately known barometric pressure via the key-pad. This causes the indicated barometric pressure to take on the value entered.

- The **Ratio** (F3) option from the calibration adjustment menu provides the facility to set-up the Ratio Reference within the instrument.

The ratio reference is used by the instrument for measuring the output from the internal transducers (except the barometric transducer) and also any external transducers used. It is therefore important that the ratio reference is correctly set-up prior to any calibration adjustment of the instruments pressure ranges.

The procedure takes the form of measuring “transducer supply”, nominally 5 Volts, and measuring “Span Cal”, nominally 0.1 Volt, and entering these values via the key-pad.

Both signals are to be found on the main printed circuit board connector PL15. Ground for both signals is on pin 3, the transducer supply being on pin 1 and the Span Cal signal on pin 2.

6.2 Instrument Calibration - Pressure (Contd...)

- The **Electrical** (F2) option of the Calibration Adjustment Menu provides access to the calibration adjustment functions for all the electrical ranges of the instrument, namely the voltmeter, ammeter, thermometer, voltage output and current output.

Calibration adjustment of the voltmeter is carried out individually for each of the four voltmeter ranges which comprise the auto-ranging voltmeter. The voltmeter range to be adjusted is selected i.e., 50V, 10V, 1V or 100mV and voltages of zero and nominally full scale are applied. The exact value of applied voltages are entered via the key-pad.

Calibration adjustment of the ammeter takes the form of applying currents of zero and just less than full scale to the ammeter and entering the exact values of the currents via the key-pad.

Calibration adjustment of the thermometer takes the form of applying a resistance of 174 ohms and 82 ohms to the thermometer input (marked PT100 on the system connector panel). The exact value of these resistors is entered via the key-pad.

Calibration adjustment of the voltage output takes the form of measuring two voltages provided between connectors B and C on the device under test connector panel. These two voltages are provided automatically by the instrument when the voltage output calibration function is selected. The values are then entered via the key-pad.

Calibration adjustment of the current output takes the form of measuring two currents provided between connectors B and C on the device under test connector panel. These two currents are provided automatically by the instrument when the current output calibration function is selected. The values are then entered via the key-pad.

6.3 Calibration of an External Pressure Transducer

To calibrate an external pressure transducer, proceed as follows.

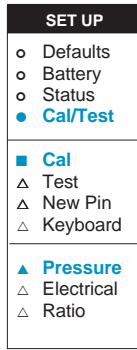

- Switch the instrument to ON.
- Connect the external transducer.
- Press **SET-UP** key and select **Cal/Test** and enter the PIN number.
- Select **Cal** from the Cal/Test Menu.
- Select **Pressure** from the Pressure Cal adjustment menu and select **External**.

Selection of External provides a listing of the external transducers available (e.g.).

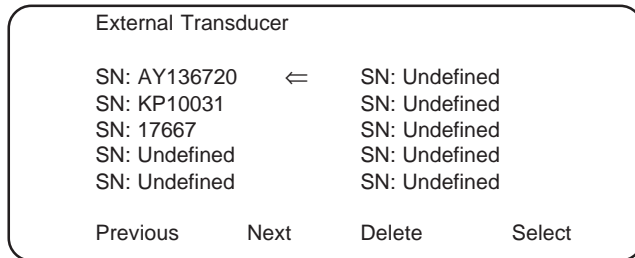

Move the cursor to the required transducer by the means of the **Previous** (F1) and **Next** (F2) keys and press select. If the required transducer is not listed in the directory, enter its parameters as detailed in Section 6.3.4.

The External Pressure Transducer Cal menu will now be displayed (e.g.)

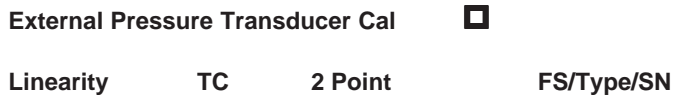

6.3.1 Two Point Calibration

To carry out a two point calibration of an external transducer, proceed as follows.

NOTE: This calibration need not be performed if a linearity Cal routine has been carried out (see Section 6.3.2).

- Select **2 Point** (F3) from the **External Pressure Transducer Cal** menu.
- Connect the external transducer to an external pressure source and pressure measurement standard (deadweight tester).
- Apply lowest pressure to the external transducer and, in response to the prompt.

Enter applied Pressure 1:

Enter the applied pressure (measured on pressure standard) on the numeric key-pad, followed by **ENT**.

- Press the **Accept** (F1) key to accept the entered pressure.
- Apply the highest pressure (F.S.) to the external transducer and in response to the prompt.

Enter applied Pressure 2:

Enter the value of the applied pressure on the numeric key-pad and press **ENT**.

- Press the **Accept** key (F1). The display briefly displays the following message (e.g.).

Calculating Coefficients - Please Wait

before returning to the **Pressure Cal Adjustment** menu.

6.3.3 Temperature Compensation

To carry out a temperature compensation run on an external transducer, proceed as follows.

- Select **TC** from the External Pressure Transducer Cal menu.
- Connect the external pressure transducer to an external pressure source and place transducer in a temperature controlled environment.
- Allow transducer environmental temperature to stabilise at (e.g.) -10°C.
- In response to the prompt (e.g.),

Temperature 1:

Enter the current temperature (e.g.) -10°C and press ENT. Press **Accept** to enter the indicated value into memory.

- In response to the **Enter Zero Pressure 1:** prompt enter the zero pressure and press the **Accept** (F1) key.
- Apply the full scale pressure to the transducer and, in response to the **Enter FS Pressure:** prompt enter the full scale pressure and press the **Accept** (F1) key.
- Repeat the application of zero pressure and full scale pressure for each of the operating temperatures throughout the range of the transducer i.e. +5°C, +23°C and +40°C. A minimum of four operating temperatures must be selected.
- On completion of calibration, press **Cal Done**. If less than four temperature points are entered, an error message will be displayed (e.g.)

At least 4 points needed

6.3.4 External Transducer Parameter Entry

If the parameters of an external transducer are not entered in the **External Transducer** directory, proceed as follows.

- At the External Transducer directory (refer to Paragraph 6.3), position the cursor at an "Undefined" location and press **Select** (F4). If all locations are occupied, one location will need to be deleted by means of the **Delete** (F3) key.
- Select **FS/Type/SN** (F3) from the External Pressure Transducer *Cal* menu.
- Select **FS** (F1) and enter the full scale reading of the transducer on the numerical key-pad and press **ENT**.
- Select **Alter Type** (F2) and select transducer type by pressing **Absolute** (F1), **Gauge** (F2) or **Differential** (F3) as required.
- Select **Serial No.** (F3) from the External Pressure Transducer Cal menu.
- Enter the serial number of the transducer on the numeric key-pad and press **ENT**.
- Press **Exit Menu**.

The External Transducer menu is now displayed from which, the newly specified transducer can now be selected.

APPENDIX A

AUTOCAL



The following sections provide a definition of the functionality provided by the AutoCal feature of the DPI 605.

1 PURPOSE

AutoCal essentially provides the user with the ability to store results (records of displayed values) in a file with a defined file identity. The file can then be printed or uploaded via the RS 232 port to a computer for storage or analysis.

2 OPERATION

Two basic modes of operation are provided.

- **Manual Mode**

Manual Mode enables the user to configure the instrument in any way and store any number of readings. It is perhaps worth mentioning here that the “Electrical Window” may be selected as manual number entry, thereby catering for dial gauge or indicator calibration. The user specifies a *File ID* and a *Serial Number* to identify the file which is created on the instrument in which the results are stored.

The *File ID* may be up to 18 characters long and *Serial Number* may be up to 17 characters long. Both may contain alphabetical and numerical characters. This manual mode of operation could be termed the “unplanned mode”.

- **Program Mode**

Program Mode allows the user to select a *Test Program* to be followed from any number of *Test Programs* previously downloaded to the instrument via the RS 232 port.

The results gathered during execution of the *Test Program* are stored in a file which is named by *File ID* and *Serial Number*.

3 PROGRAM MODE AUTOCAL SYSTEM OVERVIEW

Test Programs are created on a computer. A software tool is necessary to perform this task (and other tasks on the computer required to implement the system). Examples of this tool could be InteCal and DPI 605 File Manager. The *Test Program* is created in “plain English”. A large number of *Test Programs* may be held on the computer at one time.

Once the program has been created, it is stored and can be downloaded to the instrument when required. After the *Test Program* is downloaded to the instrument it can subsequently be executed. Results obtained during the execution of a *Test Program* are stored in a *Results File*. The file (on the instrument) is identified by *File ID* and *Serial Number*.

The first *Results File* created on the instrument for a given *Test Program* has a “>1” symbol appended to the *Serial Number*. This serves as an ‘as found marker’. *Results Files* marked in this way are never overwritten by *Results Files* produced by subsequent executions of the same *Test Program*.

If the same *Test Program* is executed a second time, the *Results File* created is identified by the same *File ID* and the same *Serial Number*, but the *Serial Number* has a “>2” symbol appended. This serves as the ‘as left marker’. *Results Files* marked in this way are always overwritten by *Results Files* produced by subsequent executions of the same *Test Program*.

The *Results File* (and *Test Program*) can then be uploaded to the computer for storage or analysis.

One field in each *Test Program* controls deletion by instrument key press of the *Test Program* itself and any associated *Results Files*. If a PIN number is specified in this field, the PIN number is required to facilitate deletion. If no PIN number is specified then deletion may be made freely.

It is possible to delete any *Test Program* and any *Results File* in the instrument from the computer (using the PIN number if specified).

4 TEST PROGRAM

Test programs contain information on the device to be tested, the required setup of the instrument for performing the test and the details of the test pressures to be used. The *Test Program* may also contain pass/fail criteria for the test.

Test Programs are transferred to the instrument in the form of a file. The structure of the contents of the file is based on the 1992 SCPI Data Interchange Format. The contents of the file is shown below.

- **File Name**

The *Test Program* file name is made up of three fields.

- The first is referred to as the File ID and must be 18 characters long (padded with spaces if necessary).

Two spaces separate the first field from the second field.

- The second field is referred to as the Serial Number and must be 17 characters long (padded with spaces if necessary).
- The last field specifies a 4 digit PIN number which is required to facilitate deletion of the *Test Program* and any associated *Results Files* on the instrument (if the PIN number is 0 or no PIN number is specified then deletion may be made freely without a PIN number).

The file name always starts with ADIF = and an example is shown below.

ADIF = Test file No 12345 PDCR 93/03 4321(P:9999

This represents a file ID of Test file No 12345
and a serial number of PDCR 93/03 4321
and PIN number 9999

- **Header Block**

The data in this block mainly details the device to be tested. The information is displayed on the instrument for the operator to confirm. No commands are contained in the Header Block. The instrument identifies each field in the Header Block by field identifiers, this means that the fields may be in any order and some (or even all) may be omitted. Recognised field identifiers are listed below.

N:	meaning notes may; be up to	40 alpha numeric characters
T:	meaning device type;	G, Gauge, g or gauge meaning gauge
		A, Abs, a or abs meaning absolute
		D, Diff, d or diff meaning differential
FS:	meaning full scale pressure;	up to 17 alpha numeric characters
NO:	meaning nominal output;	up to 15 alpha numeric characters
MP:	meaning maximum pressure;	up to 14 alpha numeric characters
FD:	meaning file creation date;	up to 15 alpha numeric characters
FT:	meaning file creation time;	up to 14 alpha numeric characters

- **Setup Block**

The data in this block is used to set-up the instrument in the way required. The data takes the form of a series of individual SCPI commands for the instrument thereby facilitating the selection of pressure units and electrical range etc. This block is therefore of variable length and content but will include commands to select the following.

Pressure units
Pressure processing
RHS Measurand (V, mA, °C)
Electrical processing
Electrical outputs
Limits

- **Test Block**

The data in this block is used to specify the actual details of the test to be performed on a step by step basis. The data takes the form of a series of individual SCPI commands to, for example, put messages on the display and log readings. This block is therefore of variable length and content. An example of some commands is shown below.

Message “please connect up device under test”
Test Pressure (P, ± limits)
Message “please go to next pressure”
Test Pressure (P, ± limits)
Message “please go to next pressure”
Test Pressure (P, ± limits)

- **End Block**

The data in this block is used to specify any activity required after the completion of the execution of the Test Block. The data takes the form of a series of individual SCPI commands and as such, is of variable length and content. The example below shows the display of a message on the screen and the specification of a BSL test on the results obtained from execution of the Test Block.

Message “please disconnect device under test”
BSL (± limits, units, messages)
Message “if device failed please replace and repeat test”

5 OUTPUT OF TEST RESULTS

Results Files in the instrument may be exported from the instrument via the RS 232 port in any of the three ways detailed below.

- **Print**

Using the instrument keypad the required *Results File* is selected for Replay and the Print option chosen. The instrument then transmits the *Results File* via the RS 232 port. The data is formatted to suit the optional DPI 605 Printer.

- **Upload**

Using the instrument keypad, the required *Results File* is selected for Replay and the Upload option chosen. The instrument then transmits the *Results File* via the RS 232 port. The data is formatted to make it easy to import the file into most common spread sheet packages (e.g.) Excel Quattro Pro etc.

- **SCPI upload**

The required *Results File* can be requested by a computer connected to the RS 232 port using the SCPI protocol detailed elsewhere. In this case, the file is formatted in line with the SCPI Data Interchange protocol.

6 TRANSFERRING FILES TO AND FROM THE INSTRUMENT

Both *Test Programs* and *Results Files* can be uploaded from and downloaded to the instrument by computer via the RS 232 port. The SCPI Standard 1992 protocol is implemented for communication over the RS 232 port. Therefore, SCPI commands are used to control the transferring of either type of file and also for housekeeping tasks such as deleting files in the instrument.

The full SCPI command set for the instrument is detailed elsewhere, but for convenience the relevant commands are explained here also.

- **Downloading Test Programs**

:MEMORY:SAVE<CR><LF> file block

The file block is the *Test Program* starting with the ADIF identifier.

- **Uploading Results Files and Test Programs**

:MEMORY:LOAD 'file name'

Uploads a file from the DPI 605 to a host computer. The file name has to be identical to the name stored in the instrument - including spaces. File are sent in the SCPI data block file format.

(e.g..) To upload a *Test Program*

:MEMORY:LOAD 'TESTING AT DRUCK SN 12345'

To upload a corresponding *Results File*

```
:MEMORY:LOAD 'TESTING AT DRUCK SN 12345 >1'
```

- **Deleting Results Files and Test Programs**

```
:MEMORY:DELETE 'file name', pin protection
```

Files are deleted by issuing the above command. If the incorrect pin protection number is sent, the file is not deleted and an error is placed in the SCPI error buffer. Files with no pin protection should be deleted with a pin protection number of 0.

```
:MEMORY:DELETE 'TESTING AT DRUCK SN 12345 ',9999
```

```
:MEMORY:DELETE:ALL
```

This command should be used with caution since all files stored in the instrument (Data Log, AutoCal Test, AutoCal results) are deleted.

- **Directory listing**

```
:MEMORY:CATLOG:ALL?
```

Sends a directory listing of all the files in the DPI 605.

```
:MEMORY:CATLOG:TEST?
```

Sends a directory listing of all the AutoCal test procedure files in the DPI 605.

```
:MEMORY:CATLOG:AUTOCAL?
```

Sends a directory listing of all the AutoCal test results files in the DPI 605.

```
:MEMORY:CATLOG:DATALOG?
```

Sends a directory listing of all the Data Log files in the DPI 605.
The data comes back as:-

```
DIR (
  TESTING AT DRUCK SN 12345
  TESTING AT DRUCK SN 12345 >1
):MEM:CAT:ALL
```

7 AUTOCAL COMMAND DEFINITIONS

The commands detailed below are *AutoCal* commands. They may be used in *AutoCal*/Test Programs to make the instrument do specific things and also prompts the operator to carry out specific operations.

When a Test Program is executed on the instrument, each individual command is executed, in order, until no more commands remain.

Many commands detailed below put text on the display of the instrument. The most common location for this information is the next to bottom line of the display, called the display message line, (referred to as the DML).

- **:MESS 'argument'**

This command has 1 mandatory argument.

- The argument is a string of up to 40 ASCII characters.

Execution of the command results in the string being displayed on the DML. **Continue** is also displayed over the F1 key and the execution of the Test Program is halted until F1 is pressed.

When F1 is pressed, the string and **Continue** both disappear and execution of the Test Program continues.

The displayed message does not appear on any print out, upload or SCPI upload.

- **:PT arg1,arg2**

This command has 2 mandatory arguments.

- The first argument is a pressure value (in the units as selected in the Setup Block).
- The second argument is a tolerance on the pressure value (in the same units).

Execution of the command results in 'Go To' being displayed at the beginning of the DML followed by the pressure value and its units. Log Point is displayed over the F1 function key.

Test program execution is halted until the F1 function key is pressed.

When F1 is pressed, if the actual pressure is equal the specified pressure value within the specified tolerance the displayed values are recorded and execution of the test program continues.

If, when F1 is pressed, the actual pressure is not within the specified tolerance, then the user is offered the choice of **Accept** (F1 key) and **Retry** (F2 key).

The logged data is presented in printout of results, upload of results and SCPI upload.

- **:GT arg1,arg2**

This command has 2 mandatory arguments.

- The first argument is a pressure value (in the units as selected in the Setup Block).
- The second argument is a tolerance on the pressure value (in the same units).

Execution of the command results in 'Go To' being displayed at the beginning of the DML followed by the pressure value and its units.

Accept is displayed over the F1 function key.

Test program execution is halted until the F1 function key is pressed.

When F1 is pressed, if the actual pressure is equal the specified pressure value within the specified tolerance then execution of the Test Program continues.

If when F1 is pressed the actual pressure is not within the specified tolerance then the user is offered the choices **Accept** (F1 key) and **Retry** (F2 key).

It should be noted that no results are recorded by the GT command.

- **:LEAK arg1,arg2,arg3**

This command has 3 mandatory arguments.

- The first is the wait time for the leak test in seconds.
- The second is the test time for the leak test in seconds.
- The third is the maximum leak rate permissible in pressure units per minute.

After completion of the leak test, if the leak rate is below that specified then the only option offered to the user is to **Continue** (F1). If the leak rate is above that specified then three options are provided, **Accept** (F1) key, **Retry** (F2) key and **Abandon** (F3) key.

All the data for the result of the leak test i.e. start pressure, end pressure, pressure drop and leak rate, together with the specified permissible leak rate and PASS/FAIL statement, are presented in print of results, upload of results and SCPI upload of results.

- **:BSL arg1,arg2,arg3,'arg4','arg5'**

This command has 5 mandatory arguments:

- The first argument is the Full Scale of the transducer under test.
- The second argument is a number representing the specified allowable deviation from the Best Straight Line.
- The third argument is the units of the second argument, (e.g.)

PUNIT To represent selected pressure unit (as specified in the Setup Block).

EUNIT To represent selected electrical unit.

RDG To represent percent of reading.

FS To represent percent of full scale.

- The fourth argument is a string of up to 40 characters which can be displayed when the BSL calculation is completed by the instrument and the specified deviation has been met.
- The fifth argument is also a 40 character string, which can be displayed when the BSL deviation exceeds that specified in 'arg2'.

The BSL command should only be used in the End Block and only if three or more points have been logged during execution of the Test Block.

Execution of the command results in the instrument calculating the Best Straight Line (BSL) through all the logged points according to a least squares fit. The deviation of each actual point from the best straight line is then calculated.

The worst case calculated deviation from the BSL is then displayed together with the specified deviation ('arg2') followed by either 'PASS' or 'FAIL'. Four options are provided;

BSL Accept (F1 Key).

Notes (F2 key - this shows the pass/fail text 'arg4' or 'arg5').

Details (F3 key - Displays Gain/Offset of BSL).

Results (F4 key - displays worst case deviation from the BSL and PASS or Fail).

The results of the BSL calculation i.e. worst case deviation, offset and gradient of the Best Straight Line together with the specified permissible deviation, are presented in printout of results, upload of results and SCPI upload of results.

- **:TSL arg1,arg2,arg3,'arg4','arg5'**

This command has 5 mandatory arguments:

- The first argument is the Full Scale of the transducer under test.
- The second argument is a number representing the specified allowable deviation from the Terminal Straight Line.
- The third argument is the units of the second argument, (e.g.)

PUNIT to represent selected pressure unit (as specified in the Setup Block).

EUNIT to represent selected electrical unit.

RDG to represent percent of reading.

FS to represent percent of full scale.

- The fourth argument is a string of up to 40 characters which can be displayed when the TSL calculation is completed by the instrument and the specified deviation has been met.
- The fifth argument is also a 40 character string, which can be displayed when the TSL deviation exceeds that specified in 'arg2'.

The TSL command can only be used in the End Block and only if three or more points have been logged during execution of the Test Block.

Execution of the command results in the instrument calculating the Terminal Straight Line (TSL) for the logged points. The deviation of each actual point from the TSL is then calculated.

The worst case calculated deviation from the TSL is then displayed together with the specified deviation ('arg2') followed by either 'PASS' or 'FAIL'.

Four options are provided;

TSL Accept (F1 Key).

Notes (F2 key - this shows the pass/fail text 'arg4' or 'arg5').

Details (F3 key - Displays Gain/Offset of TSL).

Results (F4 key - displays worst case deviation from the TSL and PASS or FAIL).

The results of TSL calculation i.e. worst case deviation, offset and gradient of Terminal Straight Line (TSL) together with the specified permissible deviation are presented in print out of results, upload of results and SCPI upload of results.

- **:ABS arg1,arg2,arg3,arg4',arg5,arg6,'arg7,'arg8**

This command has eight mandatory arguments:

- The first argument represents the zero point (pressure) of the transducer under test.
- The second argument represents the zero point of the instrument's electrical output.
- The third argument represents the full scale point (pressure) of the transducer under test.
- The fourth argument represents the full scale point of the instrument's electrical output.
- The fifth argument is a number representing the specified allowable deviation from the Absolute Straight Line.

- The sixth specifies the units of the fifth argument.

PUNIT	To represent selected pressure unit (as specified in the Setup Block).
EUNIT	To represent selected electrical unit.
RDG	To represent percent of reading.
FS	To represent percent of full scale.

- The seventh argument is a string of up to 40 characters which can be displayed when the ABS calculation is completed by the instrument and the specified deviation has been met.
- The eighth argument is also a 40 character string which can be displayed when the ABS deviation exceeds that specified in 'arg5'.

PUNIT	To represent selected pressure unit (as specified in the Setup Block).
EUNIT	To represent selected electrical unit.
RDG	To represent percent of reading.
FS	To represent percent of full scale.

- **:INFO 'argument'**

This command has 1 mandatory argument.

- The argument is a string of up to 40 characters.

Execution of the command results in the string being placed in the Results File and it therefore also appears on a print of the results file, it is also presented in an upload of the results and SCPI upload of results.

The string is never displayed on the instrument.

- **:NOTE 'argument'**

This command has 1 mandatory string argument.

Execution of the command results in the string being displayed at the beginning of the DML. The remainder of the DML is reserved for the operator to enter alpha numeric characters.

Both the argument for the command and the characters entered by the operator are presented on the results printout, results upload and SCPI upload.

The :INFO command is used by the instrument itself to put BSL and TSL analysis data into Result Files.

8 EXAMPLES

Two examples of *Test Programs* together with corresponding *Results Files* extracted from an instrument (in each of the three possible ways) are shown below.

● Example 1

The following example conveys the details below

File ID:	ABCDEFGHIJKLMNOPQR
Serial Number:	12345678901234567
Pin Protection number:	9999

In the Header Block the following details are shown

Type:	gauge
Full Scale:	10 psi
Nominal Output:	100 mV
Max pressure:	15 bar
File time:	15/3/93
File Time:	09:35:50

The setup block does the following things:

- Adds an info line to the result file
- Prompts the use to enter his employee number and adds the prompt and answer to the results file
- Sets the instrument to internal pressure range
- Sets the pressure units to psi
- Selects the voltmeter (The ammeter or thermometer are the other options).
- Sets the *Prog Output Voltage* to 5 volts (without turning it on or bringing it onto the screen)
- Brings the Voltage output onto the screen (in the off state)

The test block does the following things

- Prompts the user to enter the ambient temperature
- Displays the message "Please connect the device under test"
- Turns on the Prog Output Voltage.
- Displays the message "Please check out basic operation"
- Instructs the user to go to 20 psi within 0.1 psi
- Performs a Leak Test with a 5 second Wait Time and a 10 second Test Time
- Instructs the user to go to 9 different pressures the first of which for example 0 psi, ± 0.1 psi
- Displays the message "All results are stored"

The end block does the following things

- Displays the message "Please disconnect the device under test"
- Turns off the Voltage Output
- Performs a BSL analysis on the results, using a fullscale of 10 psi, with a specified permissible maximum deviation of 0.1 psi with the error expressed as a percent of fullscale
- Displays the message "Test is now complete"

- Example 1 - Test Program

```
ADIF = ABCDEFGHIJKLMNOPQR 12345678901234567(P:9999
IDENTIFY(
  N:Situated near main boiler feed
  T:gauge
  FS:10.0 psi
  NO:100 mV
  MP:15.0 psi
  FD:15/3/93
  FT:09:35:50
)
SETUP(
  :INFO 'TEST PROGRAM COMPILED WITH 605 FILE MANAGER'
  :NOTE 'Please enter your employee No '
  :SENSE:PRESSURE:RANGE INTERNAL
  :UNIT PSI
  :SENSE:VOLTAGE
  :SOURCE:VOLTAGE 5.0
  :SYSTEM:KEY 'VOLTSOUT','F3'
)
TEST(
  :NOTE 'Enter ambient temperature '
  :MESS 'Please connect device under test'
  :SOURCE:VOLTAGE:STATUS ON
  :MESS 'Please test out basic operation'
  :GT 20,0.1
  :LEAK 5,10,0.01
  :PT 0.0,0.1
  :PT 2.5,0.1
  :PT 5.0,0.1
  :PT 7.5,0.1
  :PT 10.0,0.1
  :PT 7.5,0.1
  :PT 5.0,0.1
  :PT 2.5,0.1
  :PT 0.0,0.1
  :MESS 'All results are stored'
)
END(
  :MESS 'Please disconnect the device under test'
  :SOURCE:VOLTAGE:STATUS OFF
  :BSL 10,0.1,FS,'Test Passed','Please report failure'
  :MESS 'Test is now complete'
)
)
```

- **Example 1 - Print of Results File**

Calibration Certificate

Test Equipment

DPI 605 Serial No. :0
 DPI 605 S/W Version :2.00
 Pressure Range :20.0 Bar

Device Under Test

File ID :ABCDEFGHIJKLMNQPQR
 Serial No :12345678901234567>1
 Date :16/03/93
 Time :15.39.36
 Device Type :gauge
 DUT Full Scale :10.00000

TEST PROG COMPILED WITH 605 FILE MANAGER

NOTE: Please enter your employee No 171

NOTE: Enter ambient temperature 21

Leaktest Results

End Pressure: -0.0004 psi
 Start Pressure: -0.0003 psi
 Pressure Drop: 0.0001 psi
 Leak Rate: 0.0007 psi /min
 Spec: 0.0100 psi /min PASS

BSL Results

Rslt:0.0059 Spec:0.1 %FS PASS
 Ofst:-2.8e-05 V Grad:-0.071 V/ psi

Test Results

PRESSURE	ELECT	VOLT O/P	TIME
psi	V	V	
-0.0005	-0.00002	5.000	15.40.19
-0.0004	-0.00001	5.000	15.40.20
-0.0003	-0.00001	5.000	15.40.22
-0.0004	-0.00001	5.000	15.40.24
-0.0004	-0.00001	5.000	15.40.25
-0.0005	-0.00001	5.000	15.40.27
-0.0005	0.00005	5.000	15.40.28
-0.0004	0.00004	5.000	15.40.29

Printed - 10.26.09 17/03/93

Authorised: _____

o Example 1 - Upload of Results File

Calibration Certificate

Test Equipment

DPI 605 Serial No. 0
 DPI 605 S/W Version 2.00
 Pressure Range 20.0 Bar

Device Under Test

File ID ABCDEFGHIJKLMNOPQR
 Serial No 12345678901234567>1
 Date 16/03/93
 Time 15:39:36
 Device Type gauge
 DUT Full Scale 10.00000
 TEST PROG COMPILED WITH 605 FILE MANAGER

NOTE: Please enter your employee No 171

NOTE: Enter ambient temperature 21

Leaktest Results

End Pressure -0.0004 psi
 Start Pressure -0.0003 psi
 Pressure Drop 0.0001 psi
 Leak Rate 0.0007 psi /min
 Spec: 0.0100 psi /min PASS

BSL Results

Rslt:0.0059 Spec:0.1 %FS PASS
 Ofst:-2.8e-05 V Grad:-0.071 V/ psi

Test Results

PRESSURE	ELECTRICAL	VOLT O/P	TIME
psi	V	V	
-0.0005	-0.00002	5.000	15:40:19
-0.0004	-0.00001	5.000	15:40:20
-0.0003	-0.00001	5.000	15:40:22
-0.0004	-0.00001	5.000	15:40:24
-0.0004	-0.00001	5.000	15:40:25
-0.0005	-0.00001	5.000	15:40:27
-0.0005	0.00005	5.000	15:40:28
-0.0004	0.00004	5.000	15:40:29

Printed 10:26:30 17/03/93

Authorised: _____



- **Example 1 - SCPI upload of Results File**

```
ADIF = ABCDEFGHIJKLMNOPQR 12345678901234567>1 (P:9999
STD (
  VERSION 1990.0
)
IDENTIFY(
  DATE 16/03/93
  TIME 15.39.36
)
DUTCH(
  DEVICE_TYPE GAUGE
  FULLSCALE 10.00000
)
INFO(
  TEST PROG COMPILED WITH 605 FILE MANAGER
)
NOTE(
  Please enter your employee No 171
)
NOTE(
  Enter ambient temperature 21
)
DIMENSION = LEAK_END(
  TYPE EXPLICIT
  UNITS psi
)
DIMENSION = LEAK_START(
  TYPE EXPLICIT
  UNITS psi
)
DIMENSION = LEAK_DROP(
  TYPE EXPLICIT
  UNITS psi
)
DIMENSION = LEAK_RATE(
  TYPE EXPLICIT
  UNITS psi /min
)
DIMENSION = TIMESTAMP(
  TYPE EXPLICIT
)
DATA(
  ACAL(
    VALUES
    -0.0004,-0.0003, 0.0001, 0.0007,15.40.12))
```

Continued on page A-21.....

Continued from page A-20.....

```
INFO(
  Leaktest Results
)
INFO(
  Spec: 0.0100 psi /min PASS
)
DIMENSION = PRESSURE(
  TYPE EXPLICIT
  UNITS psi
  TRANSDUCER_FS 290.0755
  TRANSDUCER_TYPE GAUGE
)
DIMENSION = ELECTRICAL(
  TYPE EXPLICIT
  UNITS VOLTS
)
DIMENSION = VOLTSOUT(
  TYPE EXPLICIT
  UNITS VOLTS
)
DIMENSION = TIMESTAMP(
  TYPE EXPLICIT
)
DATA(
  ACAL(
    VALUES
    -0.0005,-0.00002, 5.000,15.40.19
    -0.0004,-0.00001, 5.000,15.40.20
    -0.0003,-0.00001, 5.000,15.40.22
    -0.0004,-0.00001, 5.000,15.40.24
    -0.0004,-0.00001, 5.000,15.40.25
    -0.0005,-0.00001, 5.000,15.40.27
    -0.0005, 0.00005, 5.000,15.40.28
    -0.0004, 0.00004, 5.000,15.40.29))
INFO(
  BSL Results
)
INFO(
  Rslt:0.0059 Spec:0.1 %FS PASS
)
INFO(
  Ofst:-2.8e-05 V Grad:-0.071 V/ psi
)
)
```

- **Example 2**

The example below conveys the following details

File ID: Druck PTX500
Serial Number: 987654321
No PIN protection for deletion of the Test Program (and therefore of associated Results Files)

In the Header Block the following details are shown

Full Scale: 7 bar
Type: gauge
Note: Not to be tested on Sundays

The setup block does the following things

- Sets the instrument to internal pressure range
- Sets the pressure units to bar
- Selects the ammeter (as opposed to the voltmeter thermometer)
- Turns on flow processing (square rooting) of the ammeter reading
- Sets the Voltage Output to 24 Volts (without turning it on or bringing it onto the screen)
- Brings the Voltage output onto the screen (in the off state)

The test block does the following things

- Turns on the Voltage Output
- Displays the message "Please check out basic operation"
- Instructs the user to go to 5 different pressures the first of which for example 0 bar ± 0.2 bar

The end block does the following things

- Displays the message "Please disconnect the device under test"
- Turns off the Voltage Output
- Performs a TSL analysis on the results, using a fullscale of 7 bar, with a specified permissible maximum deviation of 0.15 bar with the error expressed in electrical units (mA because the ammeter was selected for the test)
- Displays the message "Dont forget to open the stop valve"

- Example 2 - Test Program

```
ADIF = Druck PTX500    987654321    (  
  IDENTIFY(  
    FS:7 Bar  
    T:gauge  
    N:Not to be tested on Sundays  
  )  
  SETUP(  
    :SENSE:PRESSURE:RANGE INTERNAL  
    :UNIT BAR  
    :SENSE:CURRENT  
    :INPUT2:FLOW:STATUS ON  
    :SOURCE:VOLTAGE 24  
    :SYSTEM:KEY 'VOLTSOUT','F3'  
  )  
  TEST(  
    :SOURCE:VOLTAGE:STATUS ON  
    :MESS 'Please test out basic operation'  
    :PT 0.0,0.2  
    :PT 3.5,0.2  
    :PT 7,0.2  
    :PT 3.5,0.2  
    :PT 0.0,0.2  
  )  
  END(  
    :MESS 'Please disconnect the device under test'  
    :SOURCE:VOLTAGE:STATUS OFF  
    :TSL 7,0.15,EUNIT,'ITS A GOOD ONE','ITS BAD '  
    :MESS 'Dont forget to open the stop valve'  
  )  
)
```

○ Example 2 - Print of Results File

Calibration Certificate

Test Equipment

DPI 605 Serial No. :0
 DPI 605 S/W Version :2.00
 Pressure Range :20.0 Bar

Device Under Test

File ID :Druck PTX500
 Serial No :987654321 >1
 Date :18/03/93
 Time :13.54.17
 Device Type :gauge
 DUT Full Scale :7.00000

TSL Results

Rslt:0.095 Spec:0.15 mA PASS
 Ofst:-5e+94 mA Grad:1e+99 mA/ bar

Test Results

PRESSURE	ELECT	VOLT O/P	TIME
bar	mA	V	
0.00005	0.093	24.000	13.54.50
0.00005	0.093	24.000	13.54.51
0.00005	0.093	24.000	13.54.52
0.00005	0.094	24.000	13.54.53
0.00005	0.095	24.000	13.54.54

Printed - 14.29.29 18/03/93

Authorised _____

o Example 2 - Upload of Results File

Calibration Certificate

Test Equipment

DPI 605 Serial No. 0
 DPI 605 S/W Version 2.00
 Pressure Range 20.0 Bar

Device Under Test

File ID Druck PTX500
 Serial No 987654321 >1
 Date 18/03/93
 Time 13:54:17
 Device Type gauge
 DUT Full Scale 7.00000

TSL Results

Rslt:0.095 Spec:0.15 mA PASS
 Ofst:-5e+94 mA Grad:1e+99 mA/ bar

Test Results

PRESSURE	ELECT	VOLT O/P	TIME
bar	mA	V	
0.00005	0.093	24.000	13:54:50
0.00005	0.093	24.000	13:54:51
0.00005	0.093	24.000	13:54:52
0.00005	0.094	24.000	13:54:53
0.00005	0.095	24.000	13:54:54

Printed 13:55:23 18/03/93

Authorised: _____



- **Example 2 - SCPI upload of Result File**

```

ADIF = Druck PTX500    987654321    >1 (P:0
  STD (
    VERSION 1990.0
  )
  IDENTIFY(
    DATE 18/03/93
    TIME 13.54.17
  )
  DUTCH(
    DEVICE_TYPE GAUGE
    FULLSCALE 7.00000
  )
  DIMENSION = PRESSURE(
    TYPE EXPLICIT
    UNITS bar
    TRANSDUCER_FS 20.00000
    TRANSDUCER_TYPE GAUGE
  )
  DIMENSION = ELECTRICAL(
    TYPE EXPLICIT
    UNITS mA
    FLOW ON
  )
  DIMENSION = VOLTSOUT(
    TYPE EXPLICIT
    UNITS VOLTS
  )
  DIMENSION = TIMESTAMP(
    TYPE EXPLICIT
  )
  DATA(
    ACAL(
      VALUES
        0.00005, 0.093, 24.000,13.54.50
        0.00005, 0.093, 24.000,13.54.51
        0.00005, 0.093, 24.000,13.54.52
        0.00005, 0.094, 24.000,13.54.53
        0.00005, 0.095, 24.000,13.54.54))
  INFO(
    TSL Results
  )
  INFO(
    Rslt:0.095 Spec:0.15 mA PASS
  )
  INFO(
    Ofst:-5e+94 mA Grad:1e+99 mA/ bar
  )
)

```

APPENDIX B
SCPI
COMMUNICATIONS
PROTOCOL



1 INTRODUCTION

The instrument's RS 232 port provides for connection of a printer and also for connection of a computer.

When the instrument is connected to a printer printing is initiated by pressing a key on the instrument. The data transmitted as a result is ASCII text formatted to suit most printers. (The only exception to this is the screen print facility which uses graphics mode to suit the DPI 605 optional printer and therefore may not suit all printers).

When the instrument is connected to a computer, bi-directional transfer of data can take place. AutoCal Test Procedures, AutoCal Results Files and Data Log Results Files may be down loaded to and uploaded from the instrument. The instrument may also be controlled via the RS 232 port. It can be instructed to take readings and measurement ranges can be selected for example. In fact full remote control of the instrument is possible, anything that can be done via the instrument's key-pad can be done via the RS 232 port as well.

For this bi-directional communication, the instrument uses the SCPI Communications Protocol. SCPI (pronounced skippy) stands for Standard Commands for Programmable Instrumentation. As the name suggests it is a language for communication with "clever" instruments. All instruments which adhere to the SCPI standard can be "talked to" with the same words. These words are called SCPI Commands.

The commands understood by the DPI 605 are part sub-set and part super-set of those defined by the SCPI standard because the instrument does not have all the facilities which are catered for by SCPI but it does have some additional facilities are not. In the fullness of time the commands which are at present specific to the DPI 605 may be officially adopted by the SCPI Consortium and it seems likely that the SCPI Standard itself will be adopted by the Institute of Electrical and Electronic Engineers to form an extension to the IEEE 488 standard.

All features, facilities and functions of the instrument are available via the SCPI protocol. The actual command words are in many cases not instantly identifiable with the instrument facilities to which they relate. Essentially this is because SCPI protocol was devised for a very generalised instrument and not specifically for the DPI 605.

Most functions of the instrument have explicit SCPI commands which relate to them, however not every aspect of the instrument is covered in this way. The most notable exception is that the calibration of the instrument itself has no explicit SCPI commands. This does not mean that the process of calibrating the instrument cannot be controlled over the RS 232 port (instead of conventionally by the keyboard). The pressing of any key on the instrument's keyboard can be simulated via the RS 232 port using the SCPI key press simulation command and in this way access to all the features not having explicit SCPI commands can be gained.

The user may realise that in principle, virtually all of the SCPI commands, with the notable exception of those which return readings, could be made redundant by using the key press simulation commands. This, however, has a number of disadvantages. One is that in general more individual commands have to be sent using key press commands than using explicit commands. More significantly, however, the explicit commands will always perform the intended function no matter where the instrument is in its menu structure when the commands are issued, regardless of the instrument's software version with (version 2.00 or above). The same is not true for the key press simulation approach, therefore, it is recommended that, where possible, use of the key press simulation command should be avoided.

Use of the SCPI commands may seem rather complex particularly to those that are not familiar with the operation of the instrument. In this document the SCPI commands are explained but explanation of the instrument functions which they control is to be found elsewhere. It is therefore strongly recommended that those wishing to use the instrument via the RS 232 port should first become competent at using the instrument via the keyboard (refer to Sections 3 and 4).

For those new to the SCPI standard, the book *A Beginners Guide To SCPI* by Barry Eppler, Published by Addison-Wesley Publishing Company Inc. for Hewlett Packard (ISBN 0-201-56350-9) is a good introduction to the subject.

2 COMMAND SYNTAX

The individual commands take the form of one word in upper or lower case, almost always preceded by a colon, for a few special commands the preceding character is a *.

Some commands may be ended with a question mark, this is the query form of the command and instructs the instrument to return a value. The returned value is always preceded by the return of the command string which caused it.

For example

```
:READ:PRESSURE?
```

would return

```
:READ:PRESS <value>
```

It should be noted that the returned command string always contains all default commands and also that the returned commands are in short form (see Section 3 of this Appendix, (Command Tree), for an explanation of short form and default commands).

The returned message is always ended with carriage return and line feed characters.

Commands are executed immediately upon receipt of a line feed character (ASCII code 10).

Several commands are typically strung together to achieve a certain objective.

For example

```
:READ:PRESSURE?
```

causes the current pressure reading to be returned by the instrument as seen above.

(Note that no spaces are included anywhere in the command string).

For some commands values have to be included within the command. For example, to set the programmable voltage output to 5 Volts the following command would be used.

```
:SOURCE:VOLTAGE 5
```

Where numbers are to be specified they are preceded by a space and may be in any format. So all the following are acceptable;

```
:SOURCE:VOLTAGE 5
:SOURCE:VOLTAGE 5.0
:SOURCE:VOLTAGE 0.5e1
```

3 COMMAND TREE

The following command tree lists all the commands which the instrument understands in a structured way.

Commands shown in rounded boxes are those which have values associated with them (even if the value is simply ON or OFF). These commands can always be ended with a question mark (making the query form of the command and instructing the instrument to return a value).

Commands shown in square boxes have no values associated with them.

The first few letters of each command are in capitals, this is the short form of the command and is returned by the instrument in response to a query. For example, :READ:BATTERY? returns :READ:BATT <value>. The full command should always be used when communicating with the instrument.

Commands shown in square brackets are default commands. This means that they will be assumed to be present when omitted. (e.g.).

```
:READ?
```

has the same meaning as

```
:READ:PRESSURE?
```

because :PRESSURE is a default command

Commands which are shown ending in <2> are those which can apply to either the electrical capabilities of the instrument or the pressure capabilities. When these commands are used they are ended with 1 to indicate pressure and 2 to indicate electrical e.g..

```
:SENSE:CURRENT
:INPUT2:ZERO
```

would select the ammeter and zero it and the following command (e.g.)

```
:INPUT1:ZERO
```

would zero the pressure range that was selected at the time of issuing the command.

In fact the number 1 is a default value and so may be omitted therefore

```
INPUT:ZERO
```

has the same meaning as the last example.

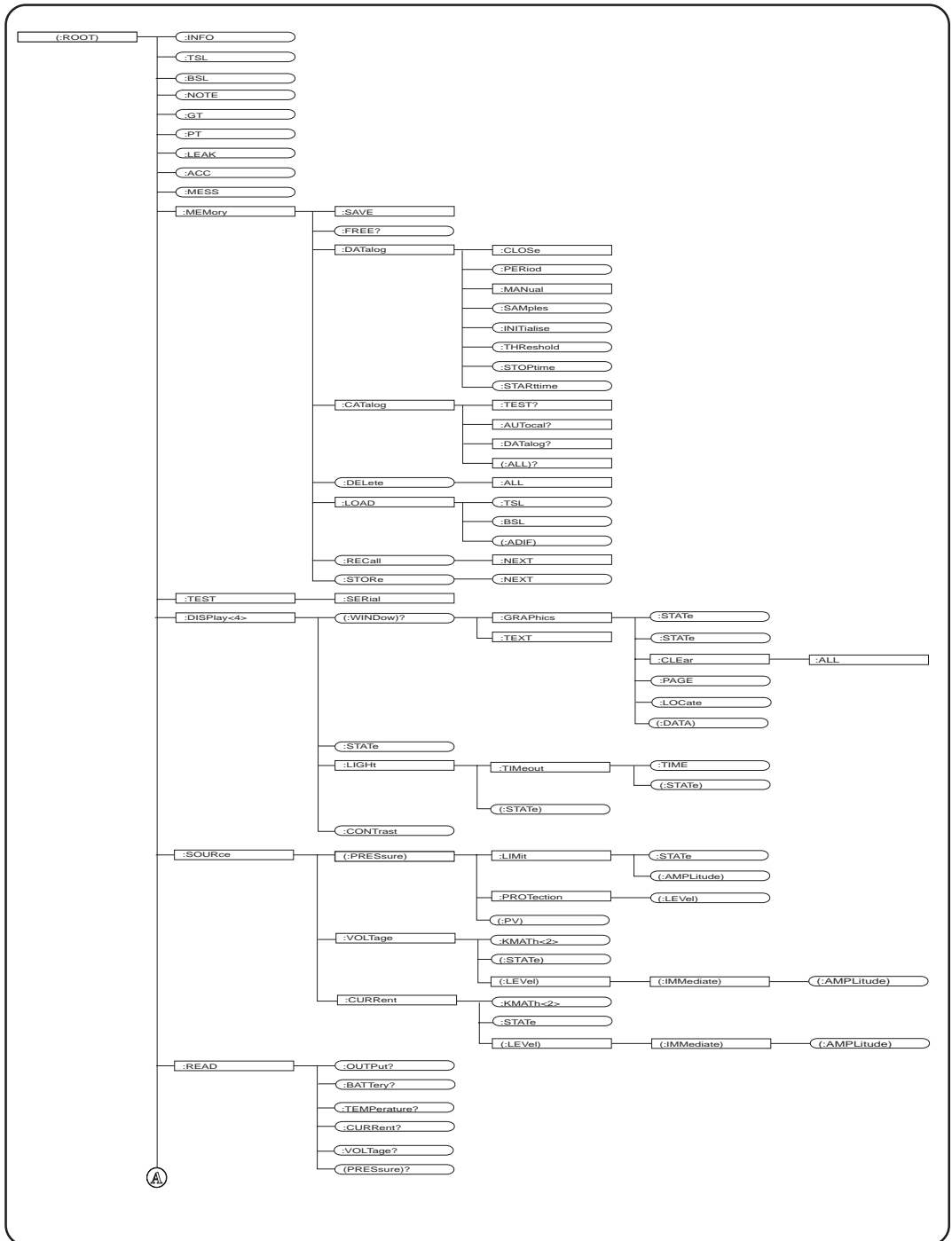

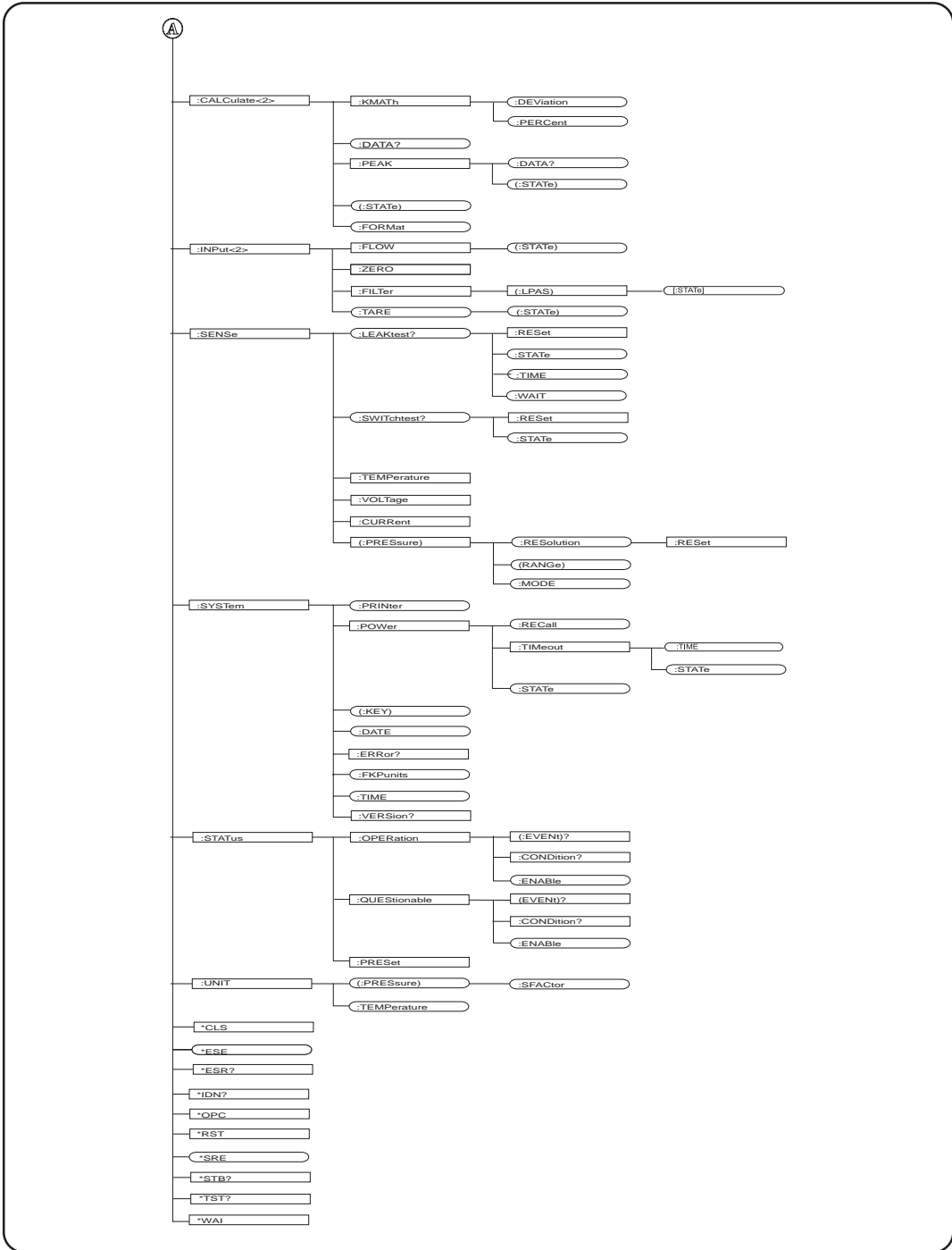

Test Equipment Depot - 800.517.8431 - 99 Washington Street Melrose, MA 02176

FAX 781.665.0780 - TestEquipmentDepot.com

4 COMMAND DEFINITIONS

There are over 150 commands in the command tree many of which are self explanatory, indeed one of the benefits of SCPI is that the actual command words do convey some meaning.

The following description describes the more important and useful commands. This should be the starting point for the newcomer to using the SCPI protocol. It does not detail every command or every facet of each command. Together with the Command Tree, however, it should provide all the information required to perform most common operations such as selecting measurement ranges and taking readings etc.

All commands follow the syntax rules and no harm can be done to the instrument by sending incorrect commands. A small amount of experimentation with an instrument should therefore successfully answer any simple queries encountered.

It should be noted that in the many examples listed below, for the sake of clarity, no use has been made of default commands and short form command names.

- :INFO,:TSL,:BSL,:NOTE,:GT,:PT,:LEAK,:ACC,:MESS

These commands all relate the AutoCal mode of operation of the instrument, they are generally only of use in AutoCal Test Procedures and definitions of them can be found elsewhere.

- :MEMORY

Relates to all memory related operations of the instrument

:MEMORY:SAVE

is used to send AutoCal Test Programs to the instrument (Refer to Appendix A - AutoCal)

:MEMORY:FREE?

returns the number of bytes of data memory available and the number of bytes used. Data memory is used for storing AutoCal Test Programs, AutoCal Results Files and Data Log Results Files. (One reading on the display occupies 4 bytes when stored and for each stored display the time is also stored which takes a further 4 bytes).

:MEMORY:DATALOG

is used in conjunction with the commands following it to set up the Data Log function of the instrument.

:MEMORY:CATALOG

is used to provide a list of files contained in the instrument. Three file types exist, AutoCal Test Programs, AutoCal Result Files and Data Log Result files.

:MEMORY:DELETE

is used to delete files contained in the instrument either by individual name or collectively.

:MEMORY:LOAD

is used to upload files from the instrument. The file must be specified by its name in single or double quotes. ADIF is the name of the SCPI file format used by the instrument and it should be noted that it is the default command following :LOAD. To upload a file called TESTFILE1, the following command string would be used

:MEMORY:LOAD 'TESTFILE1'

The :TSL and :BSL commands can be used when uploading AutoCal Results Files to perform TSL and BSL calculations on the results if these were not performed as part of the test itself (see AutoCal Description Appendix A).

:MEMORY:RECALL

provides a means of uploading the contents of the memory locations found under the STORE and RECALL buttons on the keyboard. A specific location may be specified by a number between 1 and 20 or simply the next location may be specified.

:MEMORY:STORE

provide a means of using the STORE function of the instrument. A specific location is specified by a number between 1 and 20. A text string follows the number and is added as a note to the stored data. The string must be in single or double quotes and separated from the number by a comma.

For example

```
:MEM:STORE 6,'This is good data'  
:MEMORY:STORE:NEXT
```

simply stores the contents of the display in the next location, together with the specified note added.

For example

```
:MEM:STORE:NEXT 'This is good data'
```

- :TEST

This is a self test facility and should not be used.

- :DISPLAY

provides complex very advanced features to control the instrument's display. It is not recommended for normal use.

- :SOURCE:PRESSURE:LIMIT

provides access to the setting of the instrument pressure alarm limit. The limit may be set to a value via the :AMPLITUDE command and enabled or disabled using the :STATE command. For example

```
:SOURCE:PRESSURE:LIMIT:STATE OFF
```

turns the limit off

```
:SOURCE:PRESSURE:LIMIT:AMPLITUDE 15.0
```

sets the limit to 15 in the current pressure units

```
:SOURCE:PRESSURE:LIMIT:STATE ON
```

turns the limit on.

```
:SOURCE:VOLTAGE:KMATH<2>
```

provides the ability to set programmable voltage output for use as an analogue output. The number 1 is appended to the :KMATH command to specify the signal source for the analogue output to be the pressure currently being

measured by the instrument.

The number 2 is appended to the :KMATH command to specify the signal source for the analogue output to be the electrical parameter currently being measured by the instrument.

Four parameters follow the :KMATH command, they are

- The low input signal value
- The corresponding low voltage output value
- The high input signal value
- The corresponding high voltage output value

For example (assuming the current pressure units were psi)

```
:SOURCE:VOLTAGE:KMATH1 3,1,15,5
```

sets the voltage output to represent pressure with 3 psi corresponding to 1 Volt and 15 psi corresponding to 5 Volts.

```
:SOURCE:STATE
```

is used to turn the voltage output on and off.

For example

```
:SOURCE:STATE ON
```

turns the output on.

```
:SOURCE:VOLTAGE:LEVEL:IMMEDIATE:AMPLITUDE
```

is used to set the value of the programmable output simply by following the command string with the desired value

```
:SOURCE:CURRENT
```

provides identical facilities for the current output to those provided for the voltage output by :SOURCE:VOLTAGE.

- :READ

provides access to values measured by the instrument.

For example

```
:READ:PRESSURE?
```

returns the current pressure reading

```
:READ:TEMPERATURE?
```

would return the current reading of temperature. If temperature was not being measured by the instrument at the time then the value returned is undefined, and an error message is placed in the error queue (see :SYSTEM:ERROR).

```
:CALCULATE<2>:KMATH:DEVIATION
```

is used to set up the Deviation function found under the Process key. Four parameters follow the :Deviation command, they are

- The lower pressure value
- The corresponding electrical value
- The higher pressure value
- The corresponding electrical value

```
:CALCULATE<2>:KMATH:PERCENT
```

is used to set up the Percent Function found under the Process key. Two parameters follow the :Percent command, they are the measurand value corresponding to zero percent the measurand value corresponding to 100 percent

```
:CALCULATE<2>:FORMAT
```

is used to select which of the mutually exclusive Processing functions is activated. The possibilities are NONE, PERCENT, DEVRDNG,DEVPUNITS, DEVFS, DEVEUNITS.

```
:CALCULATE<2>:STATE
```

is used to turn the selected processing functions ON and OFF

:CALCULATE<2>:DATA?

returns the pressure or electrical reading (effectively the same as the :READ command)

:CALCULATE<2>:PEAK

provides access to the Peak function found under the Process key. (Note that this is not mutually exclusive with the other processing functions).

- :INPUT<2>

provides access to the Flow, Zero, Filter and Tare functions found under the Process keys of the instrument.

For example

:INPUT1:FILTER:LPAS:STATE ON

would turn on the filter on the pressure reading.

and

:INPUT2:TARE 4.0

:INPUT2:TARE:STATE ON

would set the electrical Tare value to 4 and turn it on (on whatever range was currently selected for display on the electrical side of the instrument).

- :SENSE:LEAKTEST

provides access to setting up the Leak Test mode of the instrument and also to the results of a Leak Test.

:SENSE:SWITCHTEST

provides access to setting up the Switch Test mode of the instrument and also to the results of a Switch test.

:SENSE:TEMPERATURE

selects temperature as the electrical measurand.

```
:SENSE:VOLTAGE
```

selects voltage as the electrical measurand.

```
:SENSE:CURRENT
```

selects current as the electrical measurand.

```
:SENSE:PRESSURE:RESOLUTION
```

is used to set the resolution of the pressure display (defined by the number of decimal places).

```
:SENSE:PRESSURE:RANGE
```

is used to select the pressure range to be displayed. One of three may be specified, INTERNAL,EXTERNAL or ATMOSPHERIC.

For example

```
:SENSE:PRESSURE:RANGE:ATMOSPHERIC
```

would select the Barometric Reference for display.

```
:SENSE:PRESSURE:MODE
```

is used to select the pressure mode as either Gauge Differential or, Absolute

For example

```
:SENSE:PRESSURE:MODE GAUGE
```

would select the current pressure range as gauge if available

- :SYSTEM

provides access to various functions.

:SYSTEM:KEY

is used for key press simulation, and is followed by one or more of the key names below in single or double quotes. More than one key press can be achieved simultaneously by stringing key names together separated by a comma.

"F1",
"F2",
"F3",
"F4",
"EXIT",
"RANGE",
"UNITS",
"LIMITS",
"PPROCESS",
"ZERO",
"VOLTS",
"MA",
"TEMP",
"EPROCESS",
"VOLTSOUT",
"MAOUT",
"LIGHT",
"SETUP",
"DATALOG",
"LEAKTEST",
"SWITCHTEST",
"PV",
"STORE",
"RECALL",
"AUTOCAL",
"0",
"1",
"2",
"3",
"4",
"5",
"6",
"7",
"8",
"9",
".",
"DEL",
"-",
"ENT"

For example

```
:SYSTEM:KEY 'SETUP','F4'
```

is the equivalent of pressing the Setup key followed by the F4 key.

```
:SYSTEM:ERROR?
```

returns the last error message to be placed in the error queue and removes it from the queue. The error queue retains the most recent five errors. If the queue overflows then a queue overflow error message is added to the queue (as the sixth entry in the queue).

- **:STATUS**

is a command provided by SCPI which is essentially only relevant where connection to the instrument is made in IEEE 488 style not RS 232.

This command should not therefore be used.

- **:UNIT:PRESSURE**

provides the ability to set the pressure display to one of the following units

bar	kg/m ²	torr	ftH ₂ O
Pa - F4	mmHg - F3	atm	ftH ₂ O ⁴
hPa	cmHg	psi - F2	Spec'l
kPa	mHg	lb/ft ²	Blank
MPa	mmH ₂ O	inHg	Blank
mbar - F1	cmH ₂ O	inH ₂ O	Blank
kg/cm ²	mH ₂ O	inH ₂ O ⁴	

For example

```
:UNIT:PRESSURE TORR
```

would configure the instrument to display pressure in Torr.

```
:UNIT:PRESSURE:SFACTOR
```

provides the ability to set the scaling factor for the special pressure unit.

:UNIT:TEMPERATURE

provides the ability to set the temperature measurement to be displayed in °C or °F

For example

:UNIT:TEMPERATURE F

would configure the instrument to display temperature in °F.

- Special Commands

These commands begin with an asterisk instead of a colon. They are called common commands by the SCPI standard. Of the 10 standard common commands shown in the Command Tree only two are usefully implemented in the DPI 605.

- *IDN?

This returns a string identifying the manufacturer of the instrument, the instrument type, its serial number and its software version number.

- *RST

This command resets the instruments display to the default condition, i.e., displaying the main Internal Pressure Range on the left hand side of the display and the Ammeter on the right. No processing functions are activated and the programmable outputs are de-activated.

5 EXAMPLE USE OF COMMANDS

The following example provides the commands to do the following.

- Set the instrument to read barometric pressure
- Set the pressure units to mbar
- Select the ammeter for the electrical measurement
- Set the programmable voltage output to 24 Volts
- Turn on the programmable voltage output
- Request a reading of pressure
- Request a reading of current

(The response from the instrument are shown in italic)

```
:SENSE ATMOSPHERIC<LF>  
:UNIT MBAR<LF>  
:SENSE:CURRENT<LF>  
:SOURCE:VOLTAGE 24<LF>  
:SOURCE:VOLTAGE:STATE ON<LF>  
:READ?<LF>  
:READ:PRES 993.85<CR><LF>  
:READ:CURRENT?  
:READ:CURR -0.0095<CR><LF>
```

6 COMMAND AND VARIABLE LISTINGS

The following two listings are provided for the advanced user. They detail all commands and give information on the variable used by each command. It is stressed that these listings are intended for the serious computer literate user who wishes to use the SCPI protocol to its full. The slightly less ambitious user may however, having thoroughly read the preceding Sections of this manual, find some helpful information contained in the listings.

The Function Listing has a entry for every path through the command tree from the root to the tip of each branch. Each path represents a command sequence. The entries are listed in alphabetical order (but starting with the so called Common Commands). Each path or command sequence is usually followed by a pseudo description. For example the command sequence :SYSTEM:KEY is followed by the pseudo description “simulate_key_cmd”. After the pseudo description the names used internally by the instrument for variables associated with the command sequence are given in order. Also provided is the type of each variable, for example Boolean, String, Numeric_Real or Enumeric (meaning enumerated).

The Variable Listing has a entry for every variable found in the Function Listing and provides further details for each one. The details provided include the maximum, minimum, default and reset values together with the defined values for enumerated types.

FUNCTION LISTING

```

/*****
* SPECTRUM SOLUTIONS - SCPI INTERPRETER *
* Copyright 1991, 1992 *
* Title: PARSER\DRUCK2.MAP *
*****/

`FUNCTION NAME          TYPE
-----          ----

*CLS
  SS_cls_cmd

*ESE
  SS_ese_cmd
    StatusEnable          NUMERIC_INT    SINGLE

*ESE?
  SS_ese_qry

*ESR?
  SS_esr_qry

*IDN?
  SS_idn_qry

*OPC
  SS_opc_cmd

*OPC?
  SS_opc_qry

*RST
  SS_rst_cmd

*SRE
  SS_sre_cmd
    ServiceReg          NUMERIC_INT    SINGLE

*SRE?
  SS_sre_qry

*STB?
  SS_stb_qry

*TST?
  SS_tst_qry

*WAI
  SS_wai_cmd

```

```

:ACC
  autocal_acc_cmd
    acc_str          STRING      SINGLE

:BSL
  autocal_bsl_cmd
    acal_bsl_fs      NUMERIC_REAL SINGLE
    acal_bsl_dev     NUMERIC_REAL SINGLE
    acal_bsl_type    ENUMERIC    SINGLE
    bsl_pass_str     STRING      SINGLE
    bsl_fail_str     STRING      SINGLE

:CALCulate:DATA?
Header Suffix: 2 1
  calc_data_qry
    calc_data_value  NUMERIC_REAL SINGLE

:CALCulate:FORMat
Header Suffix: 2 1
  calc_format_cmd
    calc_form        ENUMERIC    SINGLE

:CALCulate:FORMat?
Header Suffix: 2 1
  calc_format_qry

:CALCulate:KMATH:DEVIation
Header Suffix: 2 1 1
  deviation_cmd
    lower_pressure   NUMERIC_REAL SINGLE
    lower_electrical NUMERIC_REAL SINGLE
    upper_pressure   NUMERIC_REAL SINGLE
    upper_electrical NUMERIC_REAL SINGLE

:CALCulate:KMATH:DEVIation?
Header Suffix: 2 1 1
  deviation_qry

:CALCulate:KMATH:PERCent
Header Suffix: 2 1 1
  percent_cmd
    percent_zero     NUMERIC_REAL SINGLE
    percent_fs       NUMERIC_REAL SINGLE

:CALCulate:KMATH:PERCent?
Header Suffix: 2 1 1
  percent_qry

:CALCulate:PEAK:DATA?
Header Suffix: 2 1 1
  peak_data_qry
    peak_data_high   NUMERIC_REAL SINGLE
    peak_data_low    NUMERIC_REAL SINGLE

```

```

:CALCulate:PEAK[:STATe]
Header Suffix: 2 1 1
  peak_state_cmd
    peak_stat          BOOLEAN    SINGLE

:CALCulate:PEAK[:STATe]?
Header Suffix: 2 1 1
  peak_state_qry

:CALCulate[:STATe]
Header Suffix: 2 1
  calc_state_cmd
    calc_stat          BOOLEAN    SINGLE

:CALCulate[:STATe]?
Header Suffix: 2 1
  calc_state_qry

:DISPlay:CONTRast
Header Suffix: 4 1
  contrast_cmd
    contrast_value     NUMERIC_REAL SINGLE

:DISPlay:CONTRast?
Header Suffix: 4 1
  contrast_qry

:DISPlay:LIGHt:TIMEout:TIME
Header Suffix: 4 1 1 1
  time_value_cmd
    time_val           NUMERIC_REAL SINGLE

:DISPlay:LIGHt:TIMEout:TIME?
Header Suffix: 4 1 1 1
  time_value_qry

:DISPlay:LIGHt:TIMEout[:STATe]
Header Suffix: 4 1 1 1
  timeout_state_cmd
    timeout_stat       BOOLEAN    SINGLE

:DISPlay:LIGHt:TIMEout[:STATe]?
Header Suffix: 4 1 1 1
  timeout_state_qry

:DISPlay:LIGHt[:STATe]
Header Suffix: 4 1 1
  light_state_cmd
    light_stat         BOOLEAN    SINGLE

:DISPlay:LIGHt[:STATe]?
Header Suffix: 4 1 1
  light_state_qry

```

```

:DISPlay:STATe
Header Suffix: 4 1
  display_state_cmd
  display_stat          BOOLEAN    SINGLE

:DISPlay:STATe?
Header Suffix: 4 1
  display_state_qry

:DISPlay[:WINDow]:GRAPhics:STATe
Header Suffix: 4 1 1 1
  graphics_display_cmd
  graphics_state       BOOLEAN    SINGLE

:DISPlay[:WINDow]:GRAPhics:STATe?
Header Suffix: 4 1 1 1
  graphics_display_qry

:DISPlay[:WINDow]:TEXT:CLEar
Header Suffix: 4 1 1 1
  display_clear_cmd

:DISPlay[:WINDow]:TEXT:CLEar:ALL
Header Suffix: 4 1 1 1 1
  text_clear_all_cmd

:DISPlay[:WINDow]:TEXT:LOCate
Header Suffix: 4 1 1 1
  display_locate_cmd
  display_x            NUMERIC_REAL  SINGLE
  display_y            NUMERIC_REAL  SINGLE

:DISPlay[:WINDow]:TEXT:LOCate?
Header Suffix: 4 1 1 1
  display_locate_qry

:DISPlay[:WINDow]:TEXT:PAGE
Header Suffix: 4 1 1 1
  display_page_cmd
  display_page_val     NUMERIC_REAL  SINGLE

:DISPlay[:WINDow]:TEXT:PAGE?
Header Suffix: 4 1 1 1
  display_page_qry

:DISPlay[:WINDow]:TEXT:STATe
Header Suffix: 4 1 1 1
  text_display_cmd
  text_state           BOOLEAN    SINGLE

:DISPlay[:WINDow]:TEXT:STATe?
Header Suffix: 4 1 1 1
  text_display_qry

```

```

:DISPlay[:WINDow]:TEXT[:DATA]
Header Suffix: 4 1 1 1
  display_text_str_cmd
    text_string          STRING          SINGLE

:DISPlay[:WINDow]:TEXT[:DATA]?
Header Suffix: 4 1 1 1
  display_text_str_qry

:DISPlay[:WINDow]?
Header Suffix: 4 1
  window_qry
    disp_string          STRING          SINGLE

:GT
  autocal_goto_cmd
    goto_value           NUMERIC_REAL  SINGLE
    goto_limit           NUMERIC_REAL  SINGLE

:INFO
  info_cmd
    info_string          STRING          SINGLE

:INPut:FILTer[:LPAS]
Header Suffix: 2 1 1

:INPut:FILTer[:LPAS][:STATe]
Header Suffix: 2 1 1 1
  filter_state_cmd
    filter_stat          BOOLEAN        SINGLE

:INPut:FILTer[:LPAS][:STATe]?
Header Suffix: 2 1 1 1
  filter_state_qry

:INPut:FLOW[:STATe]
Header Suffix: 2 1 1
  flow_cmd
    flow_state           BOOLEAN        SINGLE

:INPut:FLOW[:STATe]?
Header Suffix: 2 1 1
  flow_qry

:INPut:TARE
Header Suffix: 2 1
  tare_value_cmd
    tare_value           NUMERIC_REAL  SINGLE

:INPut:TARE:STATe
Header Suffix: 2 1 1
  tare_state_cmd
    state                BOOLEAN        SINGLE

```

```

:INPut:TARE:STATe?
Header Suffix: 2 1 1
tare_state_qry

:INPut:TARE?
Header Suffix: 2 1
tare_value_qry

:INPut:ZERO
Header Suffix: 2 1
input_zero_cmd

:LEAK
autocal_leak_cmd
acal_wait          NUMERIC_REAL  SINGLE
acal_time          NUMERIC_REAL  SINGLE
acal_leak_error    NUMERIC_REAL  SINGLE

:MEMory:CATalog:AUTocal?
cat_autocal_qry

:MEMory:CATalog:DATalog?
cat_dataalog_qry

:MEMory:CATalog:TEST?
cat_test_qry

:MEMory:CATalog:[ALL]?
cat_all_qry

:MEMory:DATalog:CLOSE
dlog_close_cmd

:MEMory:DATalog:INITialise
dlog_init_log_cmd
dlog_init_str      STRING          SINGLE
dlog_init_type     ENUMERIC         SINGLE

:MEMory:DATalog:MANual
dlog_manual_cmd

:MEMory:DATalog:PERiod
dlog_period_cmd
period_hrs         NUMERIC_REAL  SINGLE
period_mins       NUMERIC_REAL  SINGLE
period_secs       NUMERIC_REAL  SINGLE

:MEMory:DATalog:PERiod?
dlog_period_qry

:MEMory:DATalog:SAMPles
dlog_samples_cmd
dlog_samples_val   NUMERIC_REAL  SINGLE

:MEMory:DATalog:SAMPles?
dlog_samples_qry

```

```

:MEMory:DATalog:STARttime
  dlog_start_time_cmd
  dlog_start_hrs      NUMERIC_REAL  SINGLE
  dlog_start_mins    NUMERIC_REAL  SINGLE

:MEMory:DATalog:STARttime?
  dlog_start_time_qry

:MEMory:DATalog:STOPtime
  dlog_stop_time_cmd
  dlog_stop_hrs      NUMERIC_REAL  SINGLE
  dlog_stop_mins    NUMERIC_REAL  SINGLE

:MEMory:DATalog:STOPtime?
  dlog_stop_time_qry

:MEMory:DATalog:THReshold
  dlog_threshold_value_cmd
  dlog_threshold_val  NUMERIC_REAL  SINGLE

:MEMory:DATalog:THReshold?
  dlog_threshold_value_qry

:MEMory:DELeTe
  delete_name_cmd
  delete_nam          STRING        SINGLE
  file_pin            NUMERIC_REAL  SINGLE

:MEMory:DELeTe:ALL
  delete_all_cmd

:MEMory:FREE?
  mem_free_qry
  bytes_avail         NUMERIC_REAL  SINGLE
  bytes_used          NUMERIC_REAL  SINGLE

:MEMory:LOAD:BSL
  bsl_load_cmd
  bsl_type            ENUMERIC      SINGLE
  bsl_fullscale       NUMERIC_REAL  SINGLE
  bsl_name            STRING        SINGLE

:MEMory:LOAD:TSL
  tsl_load_cmd
  tsl_type            ENUMERIC      SINGLE
  tsl_fullscale       NUMERIC_REAL  SINGLE
  tsl_name            STRING        SINGLE

:MEMory:LOAD[:ADIF]
  adif_value_cmd
  adif_val            STRING        SINGLE

:MEMory:RECall
  recall_value_cmd
  recall_val          NUMERIC_REAL  SINGLE

```

:MEMory:RECall:NEXT recall_next_cmd			
:MEMory:RECall? recall_value_qry			
:MEMory:SAVE file_save_cmd			
:MEMory:STORE store_value_cmd			
store_val	NUMERIC_REAL	SINGLE	
store_val_txt	STRING	SINGLE	
:MEMory:STORE:NEXT store_next_cmd			
store_next_txt	STRING	SINGLE	
:MESS autocal_mess_cmd			
mess_str	STRING	SINGLE	
:NOTE note_cmd			
note_string	STRING	SINGLE	
:PT autocal_point_cmd			
point_value	NUMERIC_REAL	SINGLE	
point_limit	NUMERIC_REAL	SINGLE	
:READ:BATTery? bat_value_qry			
bat_val	NUMERIC_REAL	SINGLE	
:READ:CURRent? read_current_qry			
current_value	NUMERIC_REAL	SINGLE	
:READ:OUTPut? output_qry			
op_value	NUMERIC_REAL	SINGLE	
:READ:TEMPerature? read_temperature_qry			
temperature_value	NUMERIC_REAL	SINGLE	
:READ:VOLTage? read_voltage_qry			
voltage_value	NUMERIC_REAL	SINGLE	
:READ[:PRESSure]? read_pressure_qry			
pressure_value	NUMERIC_REAL	SINGLE	

:SENSe:CURRent			
select_current_cmd			
:SENSe:LEAKtest:RESet			
leaktest_reset_cmd			
:SENSe:LEAKtest:STATe			
leaktest_state_cmd			
leaktest_stat	BOOLEAN	SINGLE	
:SENSe:LEAKtest:STATe?			
leaktest_state_qry			
:SENSe:LEAKtest:TIME			
leaktime_value_cmd			
leaktime_hrs	NUMERIC_REAL	SINGLE	
leaktime_mins	NUMERIC_REAL	SINGLE	
leaktime_secs	NUMERIC_REAL	SINGLE	
:SENSe:LEAKtest:TIME?			
leaktime_value_qry			
:SENSe:LEAKtest:WAIT			
wait_value_cmd			
wait_hrs	NUMERIC_REAL	SINGLE	
wait_mins	NUMERIC_REAL	SINGLE	
wait_secs	NUMERIC_REAL	SINGLE	
:SENSe:LEAKtest:WAIT?			
wait_value_qry			
:SENSe:LEAKtest?			
leaktest_value_qry			
leak_para	STRING	SERIES	
:SENSe:SWITChtest:RESet			
switchtest_reset_cmd			
:SENSe:SWITChtest:STATe			
switchtest_state_cmd			
switchtest_stat	BOOLEAN	SINGLE	
:SENSe:SWITChtest:STATe?			
switchtest_state_qry			
:SENSe:SWITChtest?			
switchtest_value_qry			
switch_para	STRING	SERIES	

Test Equipment Depot - 800.517.8431 - 99 Washington Street Melrose, MA 02176

FAX 781.665.0780 - TestEquipmentDepot.com

```

:SENSe:TEMPerature
  select_temperature_cmd

:SENSe:VOLTage
  select_voltage_cmd

:SENSe[:PRESSure]

:SENSe[:PRESSure]

:SENSe[:PRESSure]:MODE
  set_pressure_mode_cmd
  "// Select Pressure measurement mode [gauge, absolute, differential]"
  p_mode          ENUMERIC    SINGLE

:SENSe[:PRESSure]:MODE?
  set_pressure_mode_qry
  "// Select Pressure measurement mode [gauge, absolute, differential]"

:SENSe[:PRESSure]:RESolution
  res_value_cmd
  res_val          NUMERIC_REAL  SINGLE

:SENSe[:PRESSure]:RESolution:RESet
  res_reset_cmd

:SENSe[:PRESSure]:RESolution?
  res_value_qry

:SENSe[:PRESSure][::RANGe]
  set_pres_range_cmd
  pressure_range   ENUMERIC      SINGLE

:SENSe[:PRESSure][::RANGe]?
  set_pres_range_qry

:SOURce:CURRent:KMATH
Header Suffix: 1 1 2
  current_analogue_cmd
  ac_low           NUMERIC_REAL  SINGLE
  ac_low_current   NUMERIC_REAL  SINGLE
  ac_high          NUMERIC_REAL  SINGLE
  ac_high_current  NUMERIC_REAL  SINGLE

:SOURce:CURRent:KMATH?
Header Suffix: 1 1 2
  current_analogue_qry

:SOURce:CURRent:STATe
  op_i_state_cmd
  current_op_state  ENUMERIC      SINGLE

```

```

:SOURce:CURRent:STATe?
  op_i_state_qry

:SOURce:CURRent[:LEVel]

:SOURce:CURRent[:LEVel][:IMMediate]

:SOURce:CURRent[:LEVel][:IMMediate][:AMPLitude]
  current_output_cmd
    op_current_value      NUMERIC_REAL  SINGLE

:SOURce:CURRent[:LEVel][:IMMediate][:AMPLitude]?
  current_output_qry

:SOURce:VOLTage:KMATH
Header Suffix: 1 1 2
  volts_analogue_cmd
    av_low      NUMERIC_REAL  SINGLE
    av_low_volts NUMERIC_REAL  SINGLE
    av_high     NUMERIC_REAL  SINGLE
    av_high_volts NUMERIC_REAL  SINGLE

:SOURce:VOLTage:KMATH?
Header Suffix: 1 1 2
  volts_analogue_qry

:SOURce:VOLTage:STATe
  op_v_state_cmd
    voltage_op_state      ENUMERIC  SINGLE

:SOURce:VOLTage:STATe?
  op_v_state_qry

:SOURce:VOLTage[:LEVel]

:SOURce:VOLTage[:LEVel][:IMMediate]

:SOURce:VOLTage[:LEVel][:IMMediate][:AMPLitude]
  voltage_output_cmd
    op_voltage_value      NUMERIC_REAL  SINGLE

:SOURce:VOLTage[:LEVel][:IMMediate][:AMPLitude]?
  voltage_output_qry

:SOURce[:PRESSure]

:SOURce[:PRESSure]:LIMit:STATe
  alarm_state_cmd
    alarm_stat      BOOLEAN  SINGLE

```

```

:SOURce[:PRESSure]:LIMit:STATe?
  alarm_state_qry

:SOURce[:PRESSure]:LIMit[:AMPLitude]
  alarm_limit_cmd
  alarm_value          NUMERIC_REAL  SINGLE

:SOURce[:PRESSure]:LIMit[:AMPLitude]?
  alarm_limit_qry

:SOURce[:PRESSure]:PROTection[:LEVel]
  protection_cmd
  protect_level       NUMERIC_REAL  SINGLE

:SOURce[:PRESSure]:PROTection[:LEVel]?
  protection_qry

:SOURce[:PRESSure][:PV]
  source_pv_cmd
  pv_source           ENUMERIC     SINGLE

:SOURce[:PRESSure][:PV]?
  source_pv_qry

:STATus:OPERation:CONDition?
  SS_status_opr_cond_qry

:STATus:OPERation:ENABle
  SS_status_opr_enable_cmd
  StatOperEnab       NUMERIC_INT  SINGLE

:STATus:OPERation:ENABle?
  SS_status_opr_enable_qry

:STATus:OPERation[:EVENT]?
  SS_status_opr_event_qry

:STATus:PRESet
  SS_status_preset_cmd

:STATus:QUEStionable:CONDition?
  SS_status_quest_cond_qry

:STATus:QUEStionable:ENABle
  SS_status_quest_enable_cmd
  StatQuesEnab      NUMERIC_INT  SINGLE

:STATus:QUEStionable:ENABle?
  SS_status_quest_enable_qry

:STATus:QUEStionable[:EVENT]?
  SS_status_quest_event_qry

```

```

:SYSTem:DATE
  date_cmd
// Set or obtain date
  year          NUMERIC_INT  SINGLE
  month         NUMERIC_INT  SINGLE
  day           NUMERIC_INT  SINGLE

:SYSTem:DATE?
  date_qry
// Set or obtain date

:SYSTem:ERRor?
  SS_system_error_qry

:SYSTem:FKPunits
  fnkeyunits_cmd
// Set or read pressure units assigned to units function keys.
  fnkey         ENUMERIC     SINGLE
  fkunits       SUFFIX_DATA  SINGLE

:SYSTem:FKPunits?
  fnkeyunits_qry
// Set or read pressure units assigned to units function keys.

:SYSTem:POWer:RECall
  recall_state_cmd
  recall_stat          BOOLEAN  SINGLE

:SYSTem:POWer:RECall?
  recall_state_qry

:SYSTem:POWer:TIMEout:TIME
  powertime_value_cmd
  powertime_val          NUMERIC_REAL  SINGLE

:SYSTem:POWer:TIMEout:TIME?
  powertime_value_qry

:SYSTem:POWer:TIMEout[:STATe]
  powerdown_state_cmd
  powerdown_stat          BOOLEAN  SINGLE

:SYSTem:POWer:TIMEout[:STATe]?
  powerdown_state_qry

:SYSTem:POWer[:STATe]
  power_state_cmd
  power_stat          BOOLEAN  SINGLE

:SYSTem:PRINter
  printer_value_cmd
  printer_val          NUMERIC_REAL  SINGLE

```

```

:SYSTem:PRINter?
  printer_value_qry

:SYSTem:TIME
  time_cmd
    hour          NUMERIC_INT  SINGLE
    minute        NUMERIC_INT  SINGLE
    second        NUMERIC_INT  SINGLE

:SYSTem:TIME?
  time_qry

:SYSTem:VERSion?
  SS_system_version_qry

:SYSTem[:KEY]
  simulate_key_cmd
    key_string    STRING      SERIES

:TEST:SERial
  serial_test_cmd

:TSL
  autocal_tsl_cmd
    aca_tsl_fs    NUMERIC_REAL  SINGLE
    aca_tsl_dev   NUMERIC_REAL  SINGLE
    aca_tsl_type  ENUMERIC     SINGLE
    tsl_pass_str  STRING      SINGLE
    tsl_fail_str  STRING      SINGLE

:UNIT:TEMPerature
  temperature_units_cmd
    temp_units    ENUMERIC     SINGLE

:UNIT:TEMPerature?
  temperature_units_qry

:UNIT[:PRESSure]
  pressure_unit_cmd
    presr_unit    SUFFIX_DATA  SINGLE

:UNIT[:PRESSure]:SFACtor
  special_factor_cmd
    ScaleFactor   NUMERIC_REAL  SINGLE

:UNIT[:PRESSure]:SFACtor?
  special_factor_qry

:UNIT[:PRESSure]?
  pressure_unit_qry

```

VARIABLE LISTING

```

/*****
* SPECTRUM SOLUTIONS - SCPI INTERPRETER *
* Copyright 1991, 1992 *
* Title: PARSER\DRUCK2.MAP *
*****/

```

VARIABLE NAME	TYPE		
vmin	vmax	vdeft	vreset
ac_high.....	NUMERIC_REAL		SINGLE
-1.00e+011	1.00e+011	0.00	0.00
ac_high_current.....	NUMERIC_REAL		SINGLE
-1.00e+011	1.00e+011	0.00	0.00
ac_low.....	NUMERIC_REAL		SINGLE
-1.00e+011	1.00e+011	0.00	0.00
ac_low_current.....	NUMERIC_REAL		SINGLE
-1.00e+011	1.00e+011	0.00	0.00
acal_bsl_dev.....	NUMERIC_REAL		SINGLE
-1.00e+011	1.00e+011	0.00	0.00
acal_bsl_fs.....	NUMERIC_REAL		SINGLE
-1.00e+011	1.00e+011	0.00	0.00
acal_bsl_type.....	ENUMERIC		SINGLE
EUNit FS RDG PUNit			
Default: PUNit			
acal_leak_error.....	NUMERIC_REAL		SINGLE
-1.00e+011	1.00e+011	0.00	0.00
acal_time.....	NUMERIC_REAL		SINGLE
1.0000	359999.00	60.00	60.00
acal_tsl_dev.....	NUMERIC_REAL		SINGLE
-1.00e+011	1.00e+011	0.00	0.00
acal_tsl_fs.....	NUMERIC_REAL		SINGLE
-1.00e+011	1.00e+011	0.00	0.00
acal_tsl_type.....	ENUMERIC		SINGLE
EUNit FS RDG PUNit			
Default: PUNit			

acal_wait.....	NUMERIC_REAL	SINGLE
1.0000	359999.00 300.00	300.00
acc_str.....	STRING	SINGLE
adif_val.....	STRING	SINGLE
alarm_stat.....	BOOLEAN	SINGLE
Default: OFF		
alarm_value.....	NUMERIC_REAL	SINGLE
-1.00e+011	1.00e+011 0.00	0.00
av_high.....	NUMERIC_REAL	SINGLE
-1.00e+011	1.00e+011 0.00	0.00
av_high_volts.....	NUMERIC_REAL	SINGLE
-1.00e+011	1.00e+011 0.00	0.00
av_low.....	NUMERIC_REAL	SINGLE
-1.00e+011	1.00e+011 0.00	0.00
av_low_volts.....	NUMERIC_REAL	SINGLE
-1.00e+011	1.00e+011 0.00	0.00
bat_val.....	NUMERIC_REAL	SINGLE
0.00	10.00 7.50	7.50
bsl_fail_str.....	STRING	SINGLE
bsl_fullscale.....	NUMERIC_REAL	SINGLE
-1.00e+011	1.00e+011 0.00	0.00
bsl_name.....	STRING	SINGLE
bsl_pass_str.....	STRING	SINGLE
bsl_type.....	ENUMERIC	SINGLE
PUNit RDG FS EUNit		
Default: PUNit		
bytes_avail.....	NUMERIC_REAL	SINGLE
0.00	65536.00 65536.00	65536.00
bytes_used.....	NUMERIC_REAL	SINGLE
0.00	65536.00 0.00	0.00
calc_data_value.....	NUMERIC_REAL	SINGLE
-1.00e+011	1.00e+011 0.00	0.00

```

calc_form..... ENUMERIC          SINGLE
  NONE  PERCent  DEVRdng  DEVPunits
  DEVFs  DEVeunits
Default: NONE

calc_stat..... BOOLEAN          SINGLE
Default: OFF

contrast_value..... NUMERIC_REAL    SINGLE
  0.00    1.0000    0.5000    0.5000

current_op_state..... ENUMERIC          SINGLE
  ELECtrical  ON    PRESsure  OFF
Default: OFF

current_value..... NUMERIC_REAL    SINGLE
  -1.00e+011  1.00e+011  0.00    0.00

day..... NUMERIC_INT          SINGLE
  1    31    1    1

delete_nam..... STRING          SINGLE

disp_string..... STRING          SINGLE

display_page_val..... NUMERIC_REAL    SINGLE
  0.00    8.00    0.00    0.00

display_stat..... BOOLEAN          SINGLE
Default: ON

display_x..... NUMERIC_REAL    SINGLE
  0.00    39.00    0.00    0.00

display_y..... NUMERIC_REAL    SINGLE
  0.00    7.00    6.00    6.00

dlog_init_str..... STRING          SINGLE

dlog_init_type..... ENUMERIC          SINGLE
  ELN    NSP    NSAMp    NE
  LSP    LSAMp    LE    ETPP
  ETPN    ETEP    ETEN    ESO
  ESC    ELP
Default:

```

```

dlog_samples_val..... NUMERIC_REAL    SINGLE
0.00  9999.00  0.00  0.00

dlog_start_hrs..... NUMERIC_REAL    SINGLE
0.00  23.00  0.00  0.00

dlog_start_mins..... NUMERIC_REAL    SINGLE
0.00  59.00  0.00  0.00

dlog_stop_hrs..... NUMERIC_REAL    SINGLE
0.00  23.00  0.00  0.00

dlog_stop_mins..... NUMERIC_REAL    SINGLE
0.00  59.00  0.00  0.00

dlog_threshold_val..... NUMERIC_REAL    SINGLE
-1.00e+010  1.00e+010  0.00  0.00

file_pin..... NUMERIC_REAL    SINGLE
0.00  9999.00  0.00  0.00

filter_stat..... BOOLEAN    SINGLE
Default: OFF

fkunits..... SUFFIX_DATA    SINGLE
ATM  CMH2O  CMHG  FTH2O
FTH2O4  HPA  INH2O  INH2O4
INHG  KG/CM2  KG/M2  KPA
LB/FT2  MBAR  MH2O  MHG
MMH2O  MMHG  MPA  PA
PSI  SPECIAL  TORR  BAR
Default: BAR

flow_state..... BOOLEAN    SINGLE
Default: OFF

fnkey..... ENUMERIC    SINGLE
F2  F3  F4  F1
Default:

goto_limit..... NUMERIC_REAL    SINGLE
-1.00e+011  1.00e+011  0.00  0.00

goto_value..... NUMERIC_REAL    SINGLE
-1.00e+011  1.00e+011  0.00  0.00

graphics_state..... BOOLEAN    SINGLE
Default: ON

```

```

hour..... NUMERIC_INT    SINGLE
  0      23      0      0

info_string..... STRING    SINGLE

key_string..... STRING    SERIES

leak_para..... STRING    SERIES

leaktest_stat..... BOOLEAN    SINGLE
Default: OFF

leaktime_hrs..... NUMERIC_REAL    SINGLE
  0.00  99.00  0.00  0.00

leaktime_mins..... NUMERIC_REAL    SINGLE
  0.00  59.00  1.0000  1.0000

leaktime_secs..... NUMERIC_REAL    SINGLE
  0.00  59.00  0.00  0.00

light_stat..... BOOLEAN    SINGLE
Default: OFF

lower_electrical..... NUMERIC_REAL    SINGLE
 -1.00e+011  1.00e+011  0.00  0.00

lower_pressure..... NUMERIC_REAL    SINGLE
 -1.00e+011  1.00e+011  0.00  0.00

mess_str..... STRING    SINGLE

minute..... NUMERIC_INT    SINGLE
  0      59      0      0

month..... NUMERIC_INT    SINGLE
  1      12      1      1

note_string..... STRING    SINGLE

op_current_value..... NUMERIC_REAL    SINGLE
  0.00  55.00  0.00  0.00

op_value..... NUMERIC_REAL    SINGLE
  0.00  60.00  0.00  0.00

op_voltage_value..... NUMERIC_REAL    SINGLE
  0.00  24.00  0.00  0.00

p_mode..... ENUMERIC    SINGLE
ABSolute DIFFerential GAUGE GAGE
Default: GAGE
    
```

Test Equipment Depot - 800.517.8431 - 99 Washington Street Melrose, MA 02176

FAX 781.665.0780 - TestEquipmentDepot.com

```

peak_data_high..... NUMERIC_REAL      SINGLE
-1.00e+011  1.00e+011  0.00  0.00

peak_data_low..... NUMERIC_REAL      SINGLE
-1.00e+011  1.00e+011  0.00  0.00

peak_stat..... BOOLEAN      SINGLE
Default: OFF

percent_fs..... NUMERIC_REAL      SINGLE
-1.00e+011  1.00e+011  0.00  0.00

percent_zero..... NUMERIC_REAL      SINGLE
-1.00e+011  1.00e+011  0.00  0.00

period_hrs..... NUMERIC_REAL      SINGLE
0.00  99.00  0.00  0.00

period_mins..... NUMERIC_REAL      SINGLE
0.00  59.00  1.0000  0.00

period_secs..... NUMERIC_REAL      SINGLE
0.00  59.00  0.00  0.00

point_limit..... NUMERIC_REAL      SINGLE
-1.00e+011  1.00e+011  0.00  0.00

point_value..... NUMERIC_REAL      SINGLE
-1.00e+011  1.00e+011  0.00  0.00

power_stat..... BOOLEAN      SINGLE
Default: ON

powerdown_stat..... BOOLEAN      SINGLE
Default: ON

powertime_val..... NUMERIC_REAL      SINGLE
1.0000  500.00  30.00  30.00

presr_unit..... SUFFIX_DATA      SINGLE
ATM  CMH2O  CMHG  F1UNIT
F2UNIT  F3UNIT  F4UNIT  FTH2O
FTH2O4  HPA  INH2O  INH2O4
INHG  KG/CM2  KG/M2  KPA
LB/FT2  MBAR  MH2O  MHG
MMH2O  MMHG  MPA  PA
PSI  SPECIAL  TORR  BAR
Default: BAR

```

pressure_range.....	ENUMERIC	SINGLE
INTERNAL EXTernal ATMospheric		
Default: INTERNAL		
pressure_value.....	NUMERIC_REAL	SINGLE
-1.00e+011 1.00e+011 0.00 0.00		
printer_val.....	NUMERIC_REAL	SINGLE
1.0000 99.00 1.0000 1.0000		
protect_level.....	NUMERIC_REAL	SINGLE
-1.00e+011 1.00e+011 0.00 0.00		
pv_source.....	ENUMERIC	SINGLE
PRESSure VACuum		
Default: PRESSURE		
recall_stat.....	BOOLEAN	SINGLE
Default: OFF		
recall_val.....	NUMERIC_REAL	SINGLE
1.0000 20.00 1.0000 1.0000		
res_val.....	NUMERIC_REAL	SINGLE
0.00 5.00 5.00 5.00		
ScaleFactor.....	NUMERIC_REAL	SINGLE
0.00 1.00e+009 1.0000 0.00		
second.....	NUMERIC_INT	SINGLE
0 59 0 0		
ServiceReg.....	NUMERIC_INT	SINGLE
0 255 0 0		
state.....	BOOLEAN	SINGLE
Default: OFF		
StatOperEnab.....	NUMERIC_INT	SINGLE
0 65535 0 0		
StatQuesEnab.....	NUMERIC_INT	SINGLE
0 65535 0 0		
StatusEnable.....	NUMERIC_INT	SINGLE
0 255 0 0		
store_next_txt.....	STRING	SINGLE

```

store_val..... NUMERIC_REAL      SINGLE
  1.0000    20.00    1.0000    1.0000

store_val_txt..... STRING          SINGLE

switch_para..... STRING          SERIES

switchtest_stat..... BOOLEAN      SINGLE
Default: OFF

tare_value..... NUMERIC_REAL      SINGLE
 -1.00e+011  1.00e+011  0.00    0.00

temp_units..... ENUMERIC          SINGLE
  C    FAR    F    CEL
Default:

temperature_value..... NUMERIC_REAL SINGLE
 -1.00e+011  1.00e+011  0.00    0.00

text_state..... BOOLEAN          SINGLE
Default: ON

text_string..... STRING          SINGLE

time_val..... NUMERIC_REAL        SINGLE
  1.0000    9999.00  5.00    5.00

timeout_stat..... BOOLEAN          SINGLE
Default: ON

tsl_fail_str..... STRING          SINGLE

tsl_fullscale..... NUMERIC_REAL    SINGLE
 -1.00e+011  1.00e+011  0.00    0.00

tsl_name..... STRING             SINGLE

tsl_pass_str..... STRING          SINGLE

tsl_type..... ENUMERIC            SINGLE
  PUNit  RDG   FS   EUNit
Default: PUNit

upper_electrical..... NUMERIC_REAL  SINGLE
 -1.00e+011  1.00e+011  0.00    0.00

upper_pressure..... NUMERIC_REAL    SINGLE
 -1.00e+011  1.00e+011  0.00    0.00

```

voltage_op_state.....	ENUMERIC	SINGLE
ELECtrical ON	PRESsure OFF	
Default: OFF		
voltage_value.....	NUMERIC_REAL	SINGLE
-1.00e+011	1.00e+011	0.00
0.00		0.00
wait_hrs.....	NUMERIC_REAL	SINGLE
0.00	99.00	0.00
0.00		0.00
wait_mins.....	NUMERIC_REAL	SINGLE
0.00	59.00	5.00
0.00		5.00
wait_secs.....	NUMERIC_REAL	SINGLE
0.00	59.00	0.00
0.00		0.00
year.....	NUMERIC_INT	SINGLE
1992	2999	1992
1992		1992

Test Equipment Depot - 800.517.8431 - 99 Washington Street Melrose, MA 02176

FAX 781.665.0780 - TestEquipmentDepot.com