

INSTRUCTION
MANUAL

BK PRECISION®

Model 9110

**Model 9110
100W Multi Range 60V/5A DC Power Supply**



WARNING

Safety Regulations

To avoid electrical shock, do not open the cabinet. Refer servicing to qualified personnel only.

To avoid injuries, always disconnect power, discharge circuits, and remove external voltage sources before touching components.

KEEP AWAY FROM LIVE CIRCUITS.

We cannot accept responsibility for any direct or indirect financial damage or loss of profit that might occur when using the power supply.

The instrument chassis and cover must be connected to an electrical ground.

Compliance Statements

Disposal of Old Electrical & Electronic Equipment (Applicable in the European Union and other European countries with separate collection systems)



This product is subject to Directive 2002/96/EC of the European Parliament and the Council of the European Union on waste electrical and electronic equipment (WEEE), and in jurisdictions adopting that Directive, is marked as being put on the market after August 13, 2005, and should not be disposed of as unsorted municipal waste. Please utilize your local WEEE collection facilities in the disposition of this product and otherwise observe all applicable requirements.

Safety Symbols



Protective Ground (Earth terminal)

Front Panel layout

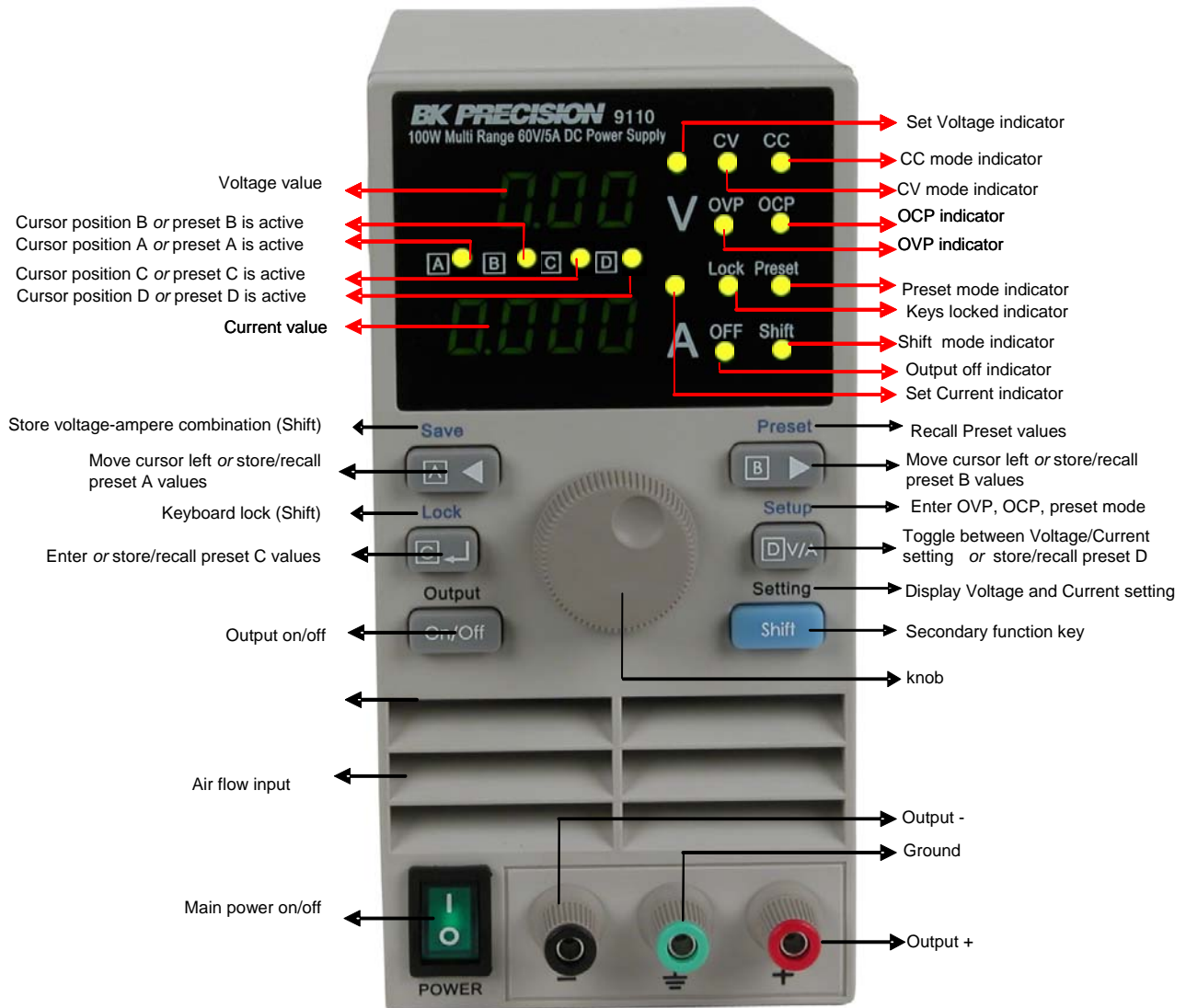

Introduction

The 9110 is a new type of power supply. Unlike conventional power supplies with fixed output ratings, the 9110 automatically recalculates voltage/current limits for each setting, forming a constant power hyperbolic shaped boundary as illustrated in the diagram below. Any Volt/Amp combination that doesn't exceed 100W, 60V or 5A can be set. By providing greatly expanded choices of maximum power volt-ampere combinations, users can cut down on the number of power supplies required and free up valuable bench space.

Example:

When setting the voltage to the maximum value of 60V, the max. current value is $100\text{W} / 60\text{V} = 1.66\text{A}$. For a 10V setting, the max current is limited to 5A, in which case the maximum output power is only 50W.

A maximum output power of 100W is possible for all V/A combination that lie on the hyperbolic curve.

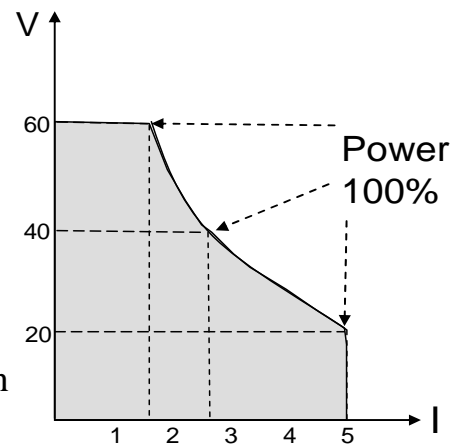

Features

- Digitally controlled, mixed linear/switching mode DC power supply
- 10mV/1mA resolution over the full range
- Bright, easy to read display
- Low ripple and noise
- Very compact size and light weight
- Output ON/OFF Control
- High reliability due to OVP, OCP and OTP (over voltage, over current, over temperature) protection
- CV (Constant Voltage) and CC (Constant Current) operation
- Store/Recall 100 groups with 4 sets of Volt/Amp memories each

Installation

Unpacking the instrument

This instrument was carefully inspected before shipment. Upon receipt, inspect the instrument for damage that might have occurred in transit. If any sign of damage is found, notify your B+K Precision distributor.

Check the list of supplied items

Verify that you have received the following items with your power supply. If anything is missing, contact your authorized B+K Precision distributor.

- Power cord
- Instruction manual

Power Requirements

The 9110 can operate on 110V AC or 220V AC. Before connecting the power cord to an AC outlet, make sure the voltage selector in the rear is set to the correct line voltage.

If necessary, replace fuses according to this table.

Line voltage	Range	Fuse
110V AC	198V to 242V	T0 3.15A, 250V
220V AC	109V to 121V	T0 2.5A, 250V

The instrument power fuse is located in a fuse compartment below the AC input receptacle. To access the fuse, first disconnect the power cord and then remove the fuse cartridge.

Power-on procedure

Turn on the instrument by pressing the main power switch on the front panel of the unit. The instrument will automatically revert to the last setting before the power was turned off.

Note

The 9 pin D-sub connector in the rear is for factory use only!

This instrument does not offer a remote control interface.

Quick Start

Set Voltage

Press the **[V/A]** key to turn the “V” indicator on. Now you can set the voltage value. Use the cursor keys **[A] [B]** to highlight the desired digit then adjust its value with the knob.

In this example the cursor is set to position **[B]** and the voltage value can be adjusted in 1V increments.

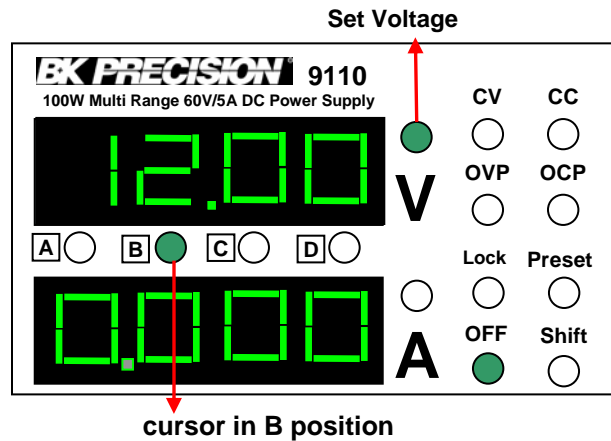

Set Current

Press the **[V/A]** key to turn on the “A” indicator. Now you can set the current value. Use cursors **[A] [B]** to highlight the desired digit then adjust its value with the knob.

In this example the cursor is set to position **[A]** and the current value can be adjusted in 1A increments.

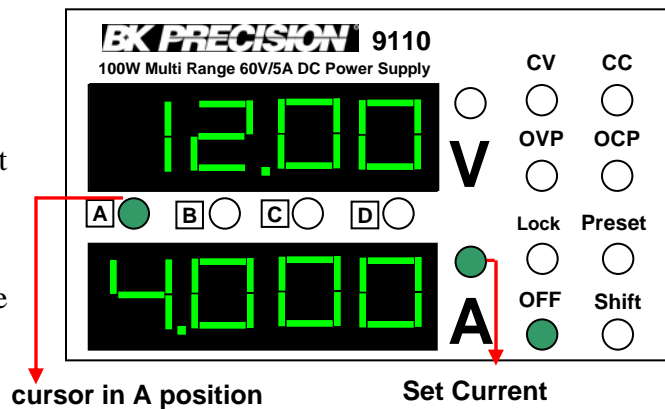

Turn output On/Off

Press **[On/Off]** to toggle the output between ON or OFF. The OFF LED is lit when the output is turned off. Each time you press the **[On/Off]** key, the display will blink for 3 seconds and the set value for Volts and Amps is displayed. Afterwards, if the instrument has been set to ON, the actual output values for voltage and current are displayed.

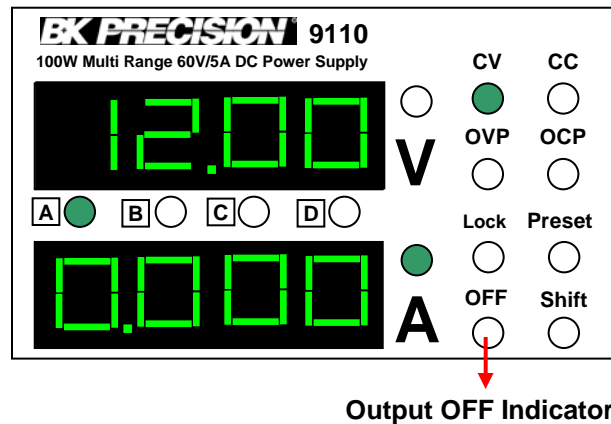



Cursor Position and Step Size

Cursor position	Voltage step size	Current step size
A		1A
B	1V	0.1A
C	0.1V	0.01A
D	0.01V	0.001A



Check the Set Voltage and Set Current Value



The power supply usually displays the actual voltage and current value. Press  twice to check the set value for voltage and current. The display will blink for 3 seconds while displaying the set values.

Key Lock Function





This function locks the keyboard to prevent unintended modification of power supply settings. Press  (Shift LED will be lit), followed by the  (Lock) key. Now the keys and the knob are locked and the Lock LED is lit. Press the Shift key followed by the Lock key again to disable the Lock function.

OVP Function

Press  then press and hold the  (Setup) key for 3 seconds.

Afterwards the LCD will display OVP and you can adjust the OVP value using the cursor keys   and the knob.

OCP Function

After the OVP value is set, press  to enter OCP mode. Use the cursor keys   and the knob  to set the OCP value.

Note

The output of the power supply will automatically turn off if the OVP and OCP value are less than the actual voltage and current value. Default setting are OVP=61V and OCP=5.1A.

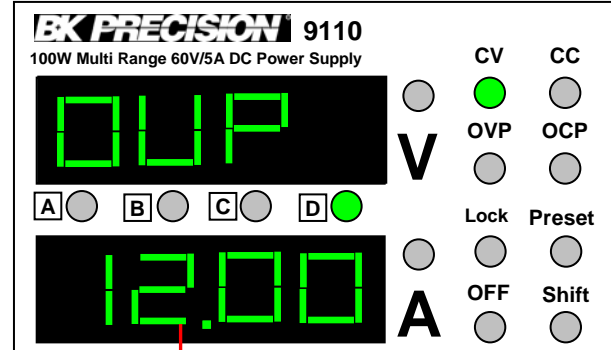



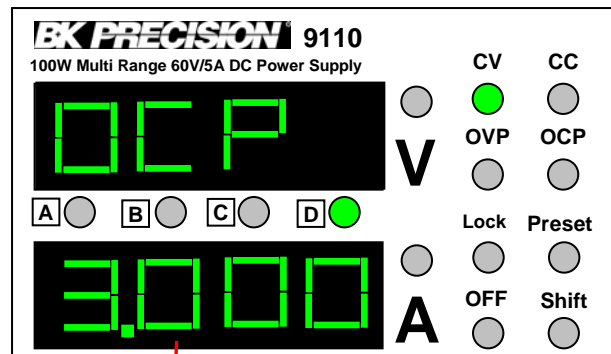

OVP Value







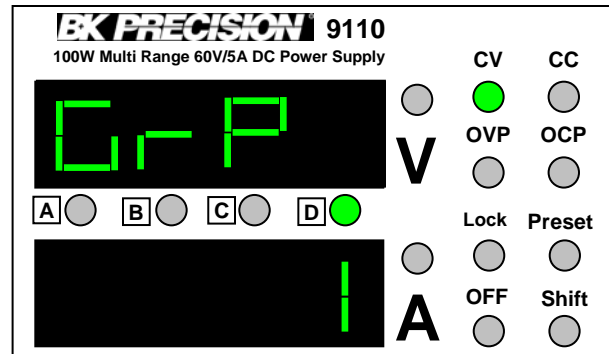

OCP Value

Selecting a Group Number









To enter this mode, you have to step through the OVP and OCP mode first, see previous 2 paragraphs. From OCP mode, press, press  to enter group mode. Use the cursors keys   and the knob  to select a group number. There are 100 groups, each group can store 4 sets of voltage/current values. Press  to confirm the entry of the selected group number.



Storing Voltage/Current sets

Store up to four sets of voltage/current values to the group number assigned in the previous paragraph. Press  followed by the  (Save) key. All 4 cursor LEDs  will blink simultaneously. Press one of the     keys to assign one of the 4 available memory location within this group. Proceed accordingly for the other 3 sets.

Preset Mode

Press  followed by the  (Preset) key. The Preset LED will turn on to indicate that the Preset mode is now active. The most recently selected group number will automatically be activated. To activate the preset values from a different group, follow the instructions in “Selecting a group number”. Press one of the     keys to recall one of the corresponding stored Volt/Amp sets assigned in the previous step. In this mode, the cursor functionality of the A,B,C, D keys is disabled. To exit this mode, press  then  (Preset).

Trouble shooting hints

If the output is disabled

1. Check if the voltage and current values are zero. If set to zero, set the voltage and current value again.
2. Check if the OFF indicator is lit. If so, press the  key to turn the output on.
3. Check if the OCP or OVP indicator is lit. If so, set the OVP or OCP value appropriately.

If keys are disabled

Check the Lock LED. If it is lit, disable the Lock function.

Specification

Model 9110

Output Rating	Voltage	0~60V
	Current	0~5A
	Power	100W
Load Regulation	Voltage	<0.01%+3mV
	Current	<0.01%+3mA
Line Regulation	Voltage	<0.01%+3mV
	Current	<0.1%+3mA
Setting Accuracy	Voltage	<0.05%+10mV
	Current	<0.2%+2mA
Display Accuracy	Voltage	<0.05%+10mV
	Current	<0.1%+2mA
Ripple	Voltage	<2.0mV rms
	Current	<5mA rms
Dimension (mm)	WxHxD	88mm x 175mm x 282mm
Weight information.	Net	5.9 lbs (2.65Kg)

Warranty

Service Information

Warranty Service: Please return the product in the original packaging with proof of purchase to the address below. Clearly state in writing the performance problem and return any leads, probes, connectors and accessories that you are using with the device.

Non-Warranty Service: Return the product in the original packaging to the address below. Clearly state in writing the performance problem and return any leads, probes, connectors and accessories that you are using with the device. Customers not on open account must include payment in the form of a money order or credit card. For the most current repair charges please visit www.bkprecision.com and click on “service/repair”.

Return all merchandise to B&K Precision Corp. with pre-paid shipping. The flat-rate repair charge for Non-Warranty Service does not include return shipping. Return shipping to locations in North American is included for Warranty Service. For overnight shipments and non-North American shipping fees please contact B&K Precision Corp.

B&K Precision Corp.
22820 Savi Ranch Parkway
Yorba Linda, CA 92887
www.bkprecision.com
714-921-9095

Include with the returned instrument your complete return shipping address, contact name, phone number and description of problem.

Limited One-Year Warranty

B&K Precision Corp. warrants to the original purchaser that its products and the component parts thereof, will be free from defects in workmanship and materials for a period of one year from date of purchase.

B&K Precision Corp. will, without charge, repair or replace, at its option, defective product or component parts. Returned product must be accompanied by proof of the purchase date in the form of a sales receipt.

To obtain warranty coverage in the U.S.A., this product must be registered by completing a warranty registration form on www.bkprecision.com within fifteen (15) days of purchase.

Exclusions: This warranty does not apply in the event of misuse or abuse of the product or as a result of unauthorized alterations or repairs. The warranty is void if the serial number is altered, defaced or removed.

B&K Precision Corp. shall not be liable for any consequential damages, including without limitation damages resulting from loss of use. Some states do not allow limitations of incidental or consequential damages. So the above limitation or exclusion may not apply to you.

This warranty gives you specific rights and you may have other rights, which vary from state-to-state.

B&K Precision Corp.
22820 Savi Ranch Parkway
Yorba Linda, CA 92887
www.bkprecision.com
714-921-9095