

# **BK PRECISION<sup>®</sup>**

## **USER MANUAL**

### **8500 SERIES DC ELECTRONIC LOADS**

Models 8500, 8502, 8510, 8512, 8514, 8518, 8520,  
8522, 8524 & 8526



# Safety

The following general safety precautions must be observed during all phases of operation of this instrument. Failure to comply with these precautions or with specific warnings elsewhere in this manual violates safety standards of design, manufacture, and intended use of the instrument. B&K Precision assumes no liability for the customer's failure to comply with these requirements.

Verify that all safety precautions are taken. Note the instrument's external markings described under "Safety Symbols".

This product is a Safety Class 1 instrument, which means it is provided with a protective earth terminal. To minimize shock hazard, the instrument chassis and cover must be connected to an electrical ground. The instrument must be connected to the AC line power through a grounded power cable, with the ground wire firmly connected to an electrical ground (safety ground) at the power outlet. Note: Any interruption of the protective (grounding) conductor or disconnection of the protective earth terminal will cause a potential shock hazard that could result in personal injury.

**DO NOT OPERATE THE INSTRUMENT IN AN EXPLOSIVE ATMOSPHERE OR IN THE PRESENCE OF FUMES OR FLAMMABLE GASES.**

**KEEP AWAY FROM LIVE CIRCUITS.**







Operating personnel must not remove instrument covers. Component replacement and internal adjustments must be made only by qualified service personnel. Do not replace components with the power cable connected. Under certain conditions, dangerous voltages may exist even with the power cable removed. To avoid injuries always disconnect power, discharge circuits and capacitors, and remove external voltage sources before touching components.

**DO NOT SERVICE OR ADJUST ALONE.**

Do not try to perform internal service or adjustment unless another person capable of rendering first aid and resuscitation is present.

## Safety Symbols

Note the instrument's external markings as follows:

	Direct current
	Alternating current
	Both direct and alternating current
	Protective earth (ground) terminal
	Caution (refer to accompanying documents)
	The WARNING sign denotes a hazard. It calls attention to a procedure, practice, or the like which, if not correctly performed or adhered to, could result in personal injury. Do not proceed beyond a WARNING sign until the indicated conditions are fully understood and met.
	The CAUTION sign denotes a hazard. It calls attention to an operating procedure, or the like, which, if not correctly performed or adhered to, could result in damage to or destruction of part or all of the product. Do not proceed beyond a CAUTION sign until the indicated conditions are fully understood and met.

# Table of Contents

<a href="#">Safety</a> .....	2
<a href="#">Safety Symbols</a> .....	2
<a href="#">Notation</a> .....	5
<a href="#">Quick reference</a> .....	6
<a href="#">Model numbers covered by this document</a> .....	6
<a href="#">Options and accessories</a> .....	6
<a href="#">Overview of instrument</a> .....	6
<a href="#">Typical tasks</a> .....	7
<a href="#">Front panel</a> .....	7
<a href="#">Standard display</a> .....	9
<a href="#">Front panel keys</a> .....	9
<a href="#">Rear panel</a> .....	10
<a href="#">Display annunciators</a> .....	11
<a href="#">Menus</a> .....	11
<a href="#">Specifications</a> .....	15
<a href="#">Environmental Conditions</a> .....	16
<a href="#">Internal Resistances</a> .....	17
<a href="#">Operational power curve</a> .....	17
<a href="#">Low Voltage Characteristics</a> .....	18
<a href="#">Slew rate</a> .....	19
<a href="#">Glossary</a> .....	21
<a href="#">Installation</a> .....	23
<a href="#">Inspection</a> .....	23
<a href="#">Items you should have received</a> .....	23
<a href="#">Instrument location</a> .....	23
<a href="#">Outline Drawings</a> .....	23
<a href="#">Bench operation</a> .....	26
<a href="#">First turn-on checkout</a> .....	27
<a href="#">Operational introduction</a> .....	28
<a href="#">Power-on state</a> .....	29
<a href="#">Constant current mode</a> .....	29
<a href="#">Constant voltage mode</a> .....	30
<a href="#">Constant power mode</a> .....	30
<a href="#">Constant resistance mode</a> .....	31
<a href="#">Timed operation</a> .....	31
<a href="#">Changing display resolution</a> .....	32
<a href="#">Increasing current resolution</a> .....	32
<a href="#">Increasing voltage resolution</a> .....	32
<a href="#">Short</a> .....	32
<a href="#">Battery test</a> .....	32
<a href="#">Transient operation</a> .....	33
<a href="#">Continuous transient operation</a> .....	33
<a href="#">Pulse transient operation</a> .....	34
<a href="#">Toggled transient operation</a> .....	35
<a href="#">Toggle between two test values</a> .....	36
<a href="#">Lists (dynamic condition)</a> .....	36
<a href="#">Test files</a> .....	37

<a href="#">Triggering</a> .....	39
<a href="#">Voltage threshold operation</a> .....	40
<a href="#">Passwords</a> .....	40
<a href="#">Protection features</a> .....	40
<a href="#">Over Voltage protection</a> .....	41
<a href="#">Over Current protection</a> .....	41
<a href="#">Over Power protection</a> .....	41
<a href="#">Reverse voltage protection</a> .....	41
<a href="#">Over Temperature protection</a> .....	42
<a href="#">Remote sensing</a> .....	42
<a href="#">Saving and Recalling settings</a> .....	43
<a href="#">Remote operation</a> .....	44
<a href="#">Communication cables</a> .....	44
<a href="#">RS232 to TTL serial converter cable IT-E131 (standard)</a> .....	44
<a href="#">USB to TTL serial converter cable IT-E132 (option)</a> .....	44
<a href="#">RS-232 settings</a> .....	45
<a href="#">Overview of DC Load programming</a> .....	45
<a href="#">Packet structure</a> .....	45
<a href="#">Status packets</a> .....	46
<a href="#">Chapter organization</a> .....	48
<a href="#">Summary of commands</a> .....	49
<a href="#">Command details</a> .....	51
<a href="#">Serial number and firmware version</a> .....	71
<a href="#">In case of trouble</a> .....	72
<a href="#">Instrument won't turn on</a> .....	72
<a href="#">Error messages during power-up</a> .....	72
<a href="#">Keypad unlock procedure (Keypad was accidentally locked)</a> .....	72
<a href="#">Appendix: Service and warranty information</a> .....	74
<a href="#">Index</a> .....	75

## Notation

<b>I-set</b>	Represents a key on the front panel. Note that some of these may be accessed in combination with the <b>Shift</b> key.
<b>OFF</b>	Annunciator, value, or message shown on the vacuum fluorescent display.
<b>CONFIG</b>	Menu item
<b>OFF</b>	Default menu item

## Quick reference

### Model numbers covered by this document

The B&K Precision DC Loads covered by this manual are:

- 8500
- 8502
- 8510
- 8512
- 8514
- 8518
- 8520
- 8522
- 8524
- 8526

Unless otherwise noted, this document will refer to all of these instruments as the DC Load. Instrument differences, where appropriate, will be noted.

### Options and accessories

The items included with the instrument are:

1. Power cord
2. User manual
3. Installation CD with application software PV8500 and USB driver for optional TTL to USB adapter
4. TTL to RS232 serial converter IT-E131
5. Test report

Optional accessories are:

6. rack mount kit IT-E151
7. TTL to USB serial adapter IT-E132

### Overview of instrument

The DC Load is a two terminal device that can be connected to DC sources. Here, a DC source is a voltage that is always positive on the DC Load's + terminal referenced to the - terminal.

DC Electronic Loads are used for design, manufacturing and evaluation of DC power supplies, batteries, and power components. Other applications include fuel-cell and photovoltaic cell test. The DC Load can operate under the following modes:

- Draw a constant voltage from a DC source.
- Draw a constant current from a DC source.
- Draw a constant power from a DC source.
- Present a constant resistance to the DC source (this behavior simulates a perfect resistor)

whose resistance doesn't change as a function of current or voltage).

The DC Load can present dynamically changing loads to the DC source with millisecond switching times. The DC Load can be remotely programmed via a serial interface (RS-232 or USB). Versatile triggering options allow the dynamic load behavior to be synchronized with other events.

A battery test mode is provided that will measure the ampere\*hour (A\*hr) characteristic of a battery. Shorts can be simulated by either the front panel or custom programming. The DC source or other components can be protected from excessive voltage, current, or power, which will cause the DC Load to shut down if excessive levels or reverse polarity are detected.

Dynamic profiles and last instrument states can be stored in non-volatile memory.

The DC Load is a versatile instrument for static and dynamic testing of power supplies, batteries, DC to DC converters, and battery chargers.

## Typical tasks

To perform the following tasks, consult the indicated sections

<b>Task</b>	<b>Section(s)</b>
Manual on/off CC, CV, CW, or CR test	<b><i>Constant current mode</i></b> <b><i>Constant voltage mode</i></b> <b><i>Constant power mode</i></b> <b><i>Constant resistance mode</i></b>
Timed on/off CC, CV, CW, or CR test	<b><i>Constant current mode</i></b> <b><i>Constant voltage mode</i></b> <b><i>Constant power mode</i></b> <b><i>Constant resistance mode</i></b> <b><i>Timed operation</i></b>
Triggered CC, CV, CW, or CR test	<b><i>Constant current mode</i></b> <b><i>Constant voltage mode</i></b> <b><i>Constant power mode</i></b> <b><i>Constant resistance mode</i></b> <b><i>Triggering</i></b>
Constant load with one transient	<b><i>Transient operation</i></b>
Load with multiple transients	<b><i>Lists (dynamic condition)</i></b>
Determine A*hr characteristic of battery	<b><i>Battery test</i></b>
Run a sequence of tests	<b><i>Test files</i></b>

## Front panel

The following picture is the front panel for the 8510 DC Load. All models have the same front panel, only the terminal section will vary based on the model.

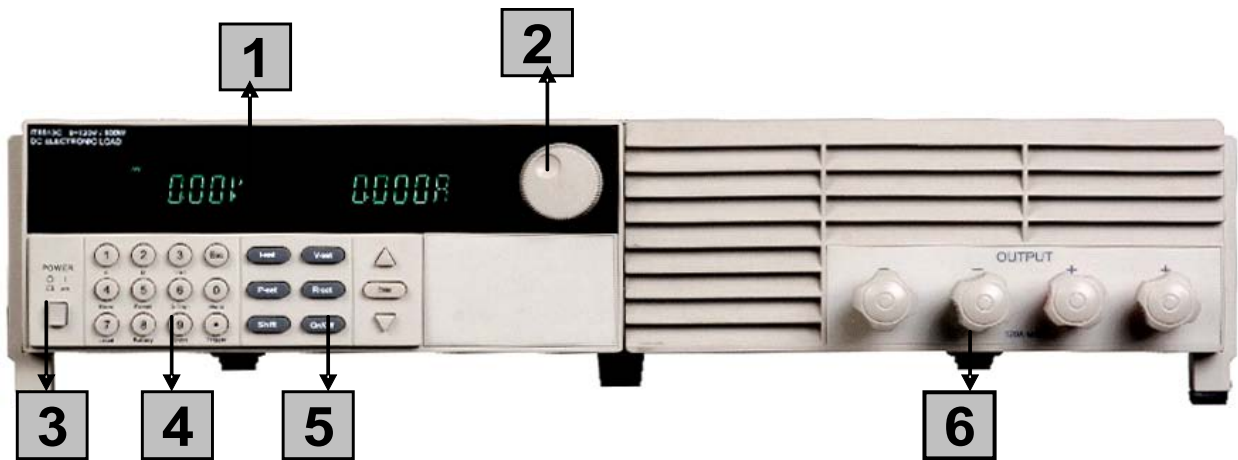

Button	Function(s)
	16-character display shows voltage and current measurements.
	Rotary knob. Turn to adjust a setting value. Press in to toggle between setting the currently-selected mode's value and reading the voltage and current, as shown in the above picture.
	Power switch to turn the instrument on or off.
	Numeric keypad: Numeric entry keys. Secondary key functions.
	Keypad: Enable/disable input. Set up the current, voltage, power, and resistance modes. Scroll through menus and options.
	<p>Input terminals. Depending on the model, you will have different types and numbers of input terminals.</p> <p><u>Models 8500/8502</u> come with one plus and one minus terminal</p> <p><u>Models 8510/8512</u> come with two positive and two negative terminals however each terminal is able to sink the maximum current supported by the instrument. Thus, it is not necessary to double up on the wires when sinking a high current unless you wish to.</p> <p><u>Models 8514/8518</u> also come with two positive and two negative terminals however it is required to <b>double up on the wires</b> when sinking a <b>current exceeding 120A</b>.</p> <p><u>Models 852x</u> come with a screw terminal block to connect the wires</p>



## Standard display

The standard display for the instrument is the voltage and current at the instrument's terminals. You may press the  $\Delta$  or  $\nabla$  keys to see the instantaneous power and the mode's parameter setting.

Standard display



## Front panel keys

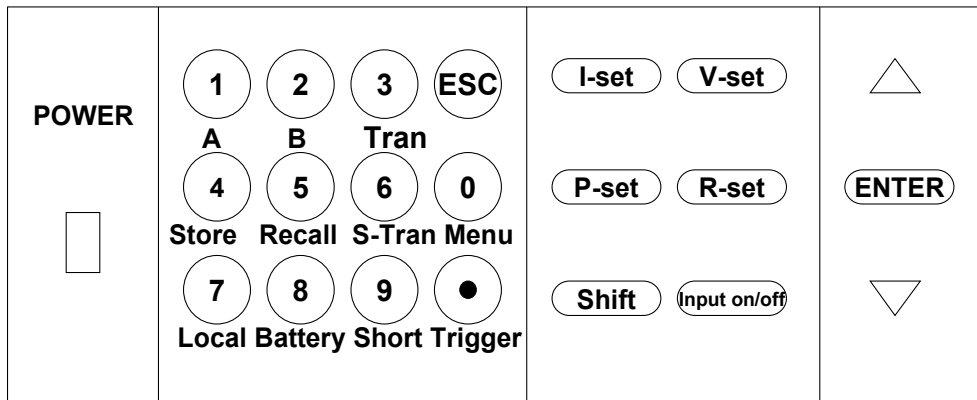

<b>V-set</b>	Choose constant voltage mode.
<b>I-set</b>	Choose constant current mode.
<b>P-set</b>	Choose constant power mode.
<b>R-set</b>	Choose constant resistance mode.
<b>Shift + A</b>	Set the current mode's load value from the A value of the corresponding transient operation. See the <b>Transient operation</b> section. This key does not work when the <b>TRAN</b> annunciator is on.
<b>Shift + B</b>	Set the current mode's load value from the B value of the corresponding transient operation. See the <b>Transient operation</b> section. This key does not work when the <b>TRAN</b> annunciator is on.
<b>Shift + Store</b>	Store the DC Load state in non-volatile memory. You may store 25 different states.
<b>Shift + Recall</b>	Recall the DC Load state from non-volatile memory. You may recall 25 different states.

<b>Shift + Menu</b>	Enter the instrument's menu system.
<b>Shift + Short</b>	Turn short circuit on or off.
<b>Shift + Tran</b>	Start or stop transient condition.
<b>Shift + Trigger</b>	Causes an immediate trigger.
<b>Shift + Battery</b>	Turn on or off battery testing function (measures battery capacity in ampere*hours).
<b>Shift + S-Tran</b>	Set transient condition parameters.
<b>On/Off</b>	Turns DC Load ON or OFF (OFF is high impedance state).
<b>Shift</b>	The shift key is used to select the alternate operation of a key, indicated by the word under the key.
▲	Scroll up key.
▼	Scroll down key.
<b>0 to 9</b>	Enter the digits 0 to 9.
.	Decimal point.
<b>Esc</b>	The escape key. It can be used to exit keyboard entry or move up a level in the menu.
<b>Enter</b>	Enter the selected value or setting.

## Rear panel

Your instrument's rear panel may look different from the following figure, but the same functionality will be present.

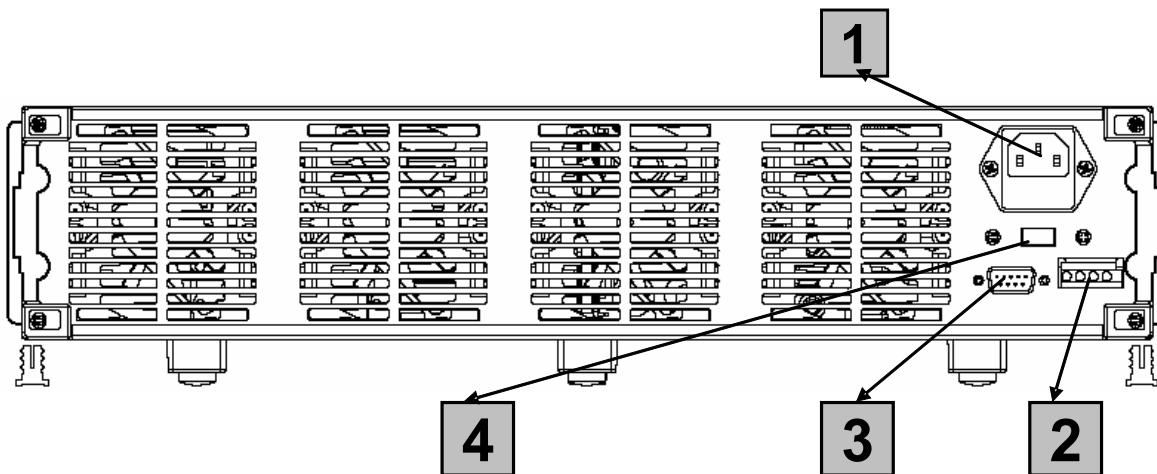

<b>1</b>	3 pin IEC320 AC input connector.
<b>2</b>	4 pin trigger and remote sensing connector.
<b>3</b>	9-Pin serial port interface connector. NOTE: This port's terminals utilize 5 volt TTL logic signals. <u>Do NOT connect an RS-232 cable with standard RS-232 voltages on the cables connectors.</u> Doing so may damage the instrument and is

	<b>not</b> covered by warranty.
4	Line voltage selection switch (110 VAC or 220 VAC)

## Display annunciators

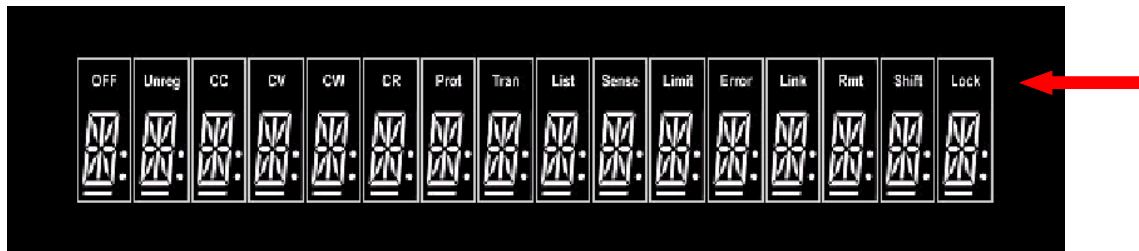

Annunciator	Meaning
<b>OFF</b>	The load is off.
<b>UNREG</b>	The input is unregulated.
<b>CC</b>	Constant current mode.
<b>CV</b>	Constant voltage mode.
<b>CW</b>	Constant power mode.
<b>CR</b>	Constant resistance mode.
<b>PROT</b>	Not used.
<b>TRAN</b>	Transient operation is enabled.
<b>LIST</b>	List mode is initiated or running.
<b>SENSE</b>	Remote sensing is on.
<b>LIMIT</b>	Not used.
<b>ERROR</b>	An error has occurred.
<b>LINK</b>	The instrument is communicating with an IT-E131 or IT-E132 communications adapter. This annunciator will stay lit for approximately 3 seconds after the last remote communication with the DC Load.
<b>RMT</b>	Instrument is in the remote state. The only active key is the <b>Local</b> key. This is set with the 0x20 remote command (see the <b>Remote programming</b> section).
<b>SHIFT</b>	The <b>Shift</b> key has been pressed.
<b>LOCK</b>	The keyboard is locked by a password.

## Menus

Use **Shift** + **Menu** to enter the menus. “Lvl” indicates the menu level, which is also indicated by the indentation of the menu item text. Scroll through the menu items using the **Δ** and **∇** keys. Return to a previous menu level by pressing the **Esc** key. Words in the heavy font such as **OFF** indicate the default menu selection.

Lvl	Menu item	Function
1	<b>CONFIG</b>	

Lvl	Menu item	Function
2	<b>INITIAL CONFIG</b>	Return instrument to factory default settings.
2	<b>POWER-ON RECALL</b>	Power on state of instrument.
3	<b>ON</b>	Remembers state at last power-down.
3	<b>OFF</b>	Does not remember state at last power-down.
2	<b>INPUT RECALL</b>	Remember whether load was ON
3	<b>ON</b>	If load was ON prior to turning the power off, the ON state will be resumed after power on. POWER-ON RECALL must also be on for this to work.
3	<b>OFF</b>	After power on, the instrument will be in the OFF state.
2	<b>KEY SOUND SET</b>	
3	<b>ON</b>	Enable audible beep when key is pressed.
3	<b>OFF</b>	No sound when key is pressed.
2	<b>KNOB LOCK SET</b>	
3	<b>ON</b>	Rotary knob is non-functional.
3	<b>OFF</b>	Rotary knob is functional.
2	<b>SHORT CUT RECALL</b>	Quickly recall a setup register by pressing a number key.
3	<b>ON</b>	Allows quick recall of a setup by pressing the number key.
3	<b>OFF</b>	Pressing a number key does not recall a setup.
2	<b>RANGE SELECT</b>	Change the precision of displayed values.
3	<b>ON</b>	Allows the user to select the instrument's range, giving better voltage and/or current resolution. Press <b>Shift</b> + <b>▲</b> or <b>Shift</b> + <b>▼</b> to toggle resolutions.
3	<b>OFF</b>	Current and voltage measurement resolution are fixed.
2	<b>REMOTE SENSE</b>	See the <i>Remote sense</i> section.
3	<b>ON</b>	Remote sensing is on.
3	<b>OFF</b>	Remote sensing is off.
2	<b>ADC UPDATE RATE</b>	Set the rate at which the display is updated.
3	<b>HIGH</b>	
3	<b>LOW</b>	
2	<b>TRIGGER SOURCE</b>	How the instrument is triggered.
3	<b>IMMEDIATE</b>	Triggered from the <b>Shift</b> + <b>Trigger</b> key.
3	<b>EXTERNAL</b>	Triggered from a TTL high signal (longer than 5 ms) at the trigger connector on rear panel.
3	<b>BUS</b>	Triggered from a serial bus command.
2	<b>CONNECT MODE</b>	
3	<b>MAXTIPLEXING</b>	Not supported with this hardware. (Should actually say "multiplexing".)
3	<b>SEPARATE</b>	

Lvl	Menu item	Function
2	<b>BAUDRATE SET</b>	Set the serial bus connection speed.
3	<b>4800</b>	
3	<b>9600</b>	
3	<b>19200</b>	
3	<b>38400</b>	
2	<b>COMM. PARITY SET</b>	Serial connection parity.
3	<b>NONE</b>	
3	<b>EVEN</b>	
3	<b>ODD</b>	
2	<b>ADDRESS SET</b>	Set the instrument's address. Must be an integer between 0x00 and 0xFE inclusive.
2	<b>KEY LOCK SET</b>	Set the instrument's password to 1 - 4 digits. Press the Enter key without any data entry to remove the password. <u>If you accidentally locked the keyboard, follow instructions at the end of this manual, chapter "in case of trouble" to unlock the keypads.</u>
2	<b>EXIT</b>	Return to prior menu level.
1	<b>SYSTEM SET</b>	
2	<b>MAX CURRENT SET</b>	Set the maximum allowed current. Exceeding this value will cause the load to shut off. This value also becomes the maximum current you can set.
2	<b>MAX POWER SET</b>	Set the maximum allowed power. Exceeding this value will cause the load to shut off. This value also becomes the maximum power you can set.
2	<b>MAX VOLTAGE SET</b>	Set the maximum allowed voltage. Exceeding this value will cause the load to shut off. This value also becomes the maximum voltage you can set.
2	<b>VOLTAGE ON SET</b>	Used to set an ON voltage threshold. See the <b><i>Voltage threshold</i></b> section.
2	<b>VOLTAGE OFF SET</b>	Used to set an OFF voltage threshold. See the <b><i>Voltage threshold</i></b> section.
2	<b>EXIT</b>	Return to prior menu level.
1	<b>LIST SET</b>	Lists are programmed sequences of load values.
2	<b>MODE SET</b>	
3	<b>FIXED MODE</b>	Load characteristics set by front panel.
3	<b>LIST MODE</b>	Load characteristics are dynamic and controlled by a list stored in memory.
2	<b>CALL LIST FILE</b>	Recall an existing list from nonvolatile memory.
3	<b>RECALL N</b>	N is list number.
2	<b>EDIT LIST FILE</b>	Note that each list file has four lists, one for each operation mode (CC, CV, CW, CR).
3	<b>CURRENT LIST</b>	
4	<b>ONCE</b>	List is executed once per trigger.

<b>Lvl</b>	<b>Menu item</b>	<b>Function</b>
4	<b>REPEAT</b>	List is repeatedly executed after the trigger is received.
3	<b>VOLTAGE LIST</b>	
4	<b>ONCE</b>	List is executed once per trigger.
4	<b>REPEAT</b>	List is repeatedly executed after the trigger is received.
3	<b>POWER LIST</b>	
4	<b>ONCE</b>	List is executed once per trigger.
4	<b>REPEAT</b>	List is repeatedly executed after the trigger is received.
3	<b>RESISTANCE LIST</b>	
4	<b>ONCE</b>	List is executed once per trigger.
4	<b>REPEAT</b>	List is repeatedly executed after the trigger is received.
2	<b>CALL TEST FILE</b>	Recalls a stored test file (see <b>Test files</b> section).
3	<b>RECALL N</b>	N is file number.
2	<b>EDIT TEST FILE</b>	See <b>Test files</b> section for more details.
2	<b>LIST STORE MODE</b>	Set how the nonvolatile memory is partitioned to store lists. You can choose between numerous short lists or fewer longer lists.
3	<b>8 X 120 STEPS</b>	
3	<b>4 X 250 STEPS</b>	
3	<b>2 X 500 STEPS</b>	
3	<b>1 X 1000 STEPS</b>	
2	<b>EXIT</b>	Return to prior menu level.
1	<b>LOAD ON TIMER</b>	Enable a timed load.
2	<b>TIMER STATE</b>	
3	<b>ON</b>	When the load timer is enabled by this menu element, the load is turned on when the <b>On/Off</b> key is pressed. After the set time period has elapsed, the load is turned off.
3	<b>OFF</b>	When the load is turned on via the <b>On/Off</b> key, the load stays ON indefinitely.
2	<b>TIMER SET</b>	Set the time period from 1 to 60000 s for the load to be on.
2	<b>EXIT</b>	Return to prior menu level.
1	<b>EXIT</b>	Return to standard display.

## Specifications

### Models 8500 & 8502 (300 W)

Parameter		8500	8502
Input rating	Voltage	0 to 120 V	0 to 500 V
	Current	1 mA to 30 A	1 mA to 15 A
	Power	300 W	

8500/8502 common characteristics				
Parameter	Range		Accuracy	Resolution
	8500	8502		
CV Mode Regulation	0.1-18 V		$\pm(0.05\%+0.02\% \text{ FS})$	1 mV
	0.1 – 120 V	0.1 – 500 V	$\pm(0.05\%+0.025\% \text{ FS})$	10 mV
CC Mode Regulation	0 – 3 A	0 – 3 A	$\pm(0.1\%+0.1\% \text{ FS})$	0.1 mA
	0 – 30 A	0 – 15 A	$\pm(0.2\%+0.15\% \text{ FS})$	1 mA
Current Measurement	0 – 3 A	0 – 3 A	$\pm(0.1\% + 0.1\% \text{ FS})$	0.1 mA
	0 – 30 A	0 – 15 A	8500: $\pm(0.2\%+0.15\% \text{ FS})$ 8502: $\pm(0.2\%+0.3\% \text{ FS})$	1 mA
Voltage Measurement	0-18 V		$\pm(0.02\% + 0.02\% \text{ FS})$	1 mV
	0-120 V	0 – 500 V	$\pm(0.02\% + 0.025\% \text{ FS})$	10 mV

### Models 8510/8512/8514/8518 (1200 & 2400 W)

Parameter		8510	8512	8514	8518
Input rating	Voltage	0 – 120 V	0 – 500 V	0 – 120 V	0 – 60 V
	Current	0 – 120 A	0 – 30 A	0 – 240 A	0 – 240 A
	Power	600 W		1200 W	

8510/8512/8514/8518 common characteristics					
Parameter	Range			Accuracy	Resolution
	8510	8512	8514 / 8518		
CV Mode Regulation	0.1-18 V			$\pm(0.05\%+0.02\% \text{ FS})$	1 mV
	0.1 V to Vmax			$\pm(0.05\%+0.025\% \text{ FS})$	10 mV
CC Mode Regulation	0-12 A	0-3 A	0-24 A	$\pm(0.1\%+0.1\% \text{ FS})$	1 mA
	0 – max Current			$\pm(0.2\%+0.15\% \text{ FS})$	10 mA
Current Measurement	0-12 A	0-3 A	0-24 A	$\pm(0.1\% + 0.1\% \text{ FS})$	1 mA
	0 – max. Current			$\pm(0.2\%+0.15\% \text{ FS})$	10 mA
Voltage Measurement	0 – 18 V			8510/8514: $(0.02\% + 0.025\% \text{ FS})$ 8512/8518: $(0.02\% + 0.02\% \text{ FS})$	1 mV
	0 - Vmax			$\pm(0.02\% + 0.025\% \text{ FS})$	10 mV

## Models 8520/8522/8524/8526 (2400W & 5000W)

Parameter		8520	8522	8524	8526
Input rating	Voltage	0 – 120 V	0 – 500 V	0 – 60 V	0 – 500 V
	Current	0 – 240 A	0 – 120 A	0 – 240 A	0 – 120 A
	Power	2400 W		5000 W	

8520/8522/8524/8526 common characteristics						
Parameter	Range				Accuracy	Resolution
	8520	8522	8524	8526		
CV Mode Regulation	0.1-18 V				$\pm(0.05\%+0.02\% \text{ FS})$	1 mV
	0.1 V to Vmax				$\pm(0.05\%+0.025\% \text{ FS})$	10 mV
CC Mode Regulation	0-24 A	0-12 A	0-24 A	0-12 A	$\pm(0.1\%+0.1\% \text{ FS})$	1 mA
	0 – max Current				$\pm(0.2\%+0.15\% \text{ FS})$	10 mA
Current Measurement	0-12 A	0-3 A	0-24 A	0-12 A	$\pm(0.1\% + 0.1\% \text{ FS})$	1 mA
	0 – max. Current				$\pm(0.2\%+0.15\% \text{ FS})$	10 mA
Voltage Measurement	0 – 18 V				8522/8526: $(0.02\% + 0.02\% \text{ FS})$	1 mV
	0 - Vmax				8520/8524: $(0.02\% + 0.025\% \text{ FS})$	10 mV

## All DC load models

common characteristics for all DC load models			
Parameter	Range	Accuracy	Resolution
CR Mode Regulation Input current $\geq$ FS 10% Input Voltage $\geq$ FS 10%	0.1 -10 $\Omega$	$\pm(1\%+0.3\% \text{ FS})$	0.001 $\Omega$
	10-99 $\Omega$	$\pm(1\%+0.3\% \text{ FS})$	0.01 $\Omega$
	100-999 $\Omega$	$\pm(1\%+0.3\% \text{ FS})$	0.1 $\Omega$
	1K-4 K $\Omega$	$\pm(1\%+0.8\% \text{ FS})$	1 $\Omega$
CW Mode Regulation Input current $\geq$ FS 10% Input Voltage $\geq$ FS 10%	0-100 W	$\pm(1\%+0.1\% \text{ FS})$	1 mW
	100 W – max Power	$\pm(1\%+0.1\% \text{ FS})$	100 mW
Power Measurement Input current $\geq$ FS 10% Input Voltage $\geq$ FS 10%	0-100 W	$\pm(1\%+0.1\% \text{ FS})$	1 mW
	100-max Power	$\pm(1\%+0.1\% \text{ FS})$	100 mW
Battery testing function	Input=0.1 V – 120 V      Max measurement capacity= 999 A/H Resolution =10 mA      Timer range=1~60000 sec		
Transition Mode	Range of Frequency 0.1 Hz-1 kHz      Frequency error rate < 0.5%		

**NOTE:** Specifications and information are subject to change without notice. Please visit [www.bkprecision.com](http://www.bkprecision.com) for the most current product information.

## Environmental Conditions

This instrument is intended for indoor use in a pollution degree 2 environment. Operating environmental limits are as follows:

Parameter	Specification
Humidity	≤ 95% relative humidity, non-condensing
Altitude	≤ 2000 m
AC Line voltage	<b>220 AV±10% , 47 ~ 63 Hz</b> <b>110 AV±10% , 47 ~ 63 Hz</b>
Operating temperature	<b>0 – 40 °C</b>
Storage temperature	<b>-10 – 60 °C</b>

### **Internal Resistances**

The internal resistances of the DC load models are less than or equal to the following values:

Model	Internal Resistance(mΩ)
8500	≤ 35
8502	≤ 200
8510	≤ 15
8512	≤ 100
8514	≤ 8
8518	≤ 5
8520	≤ 45
8522	≤ 30
8524	≤ 6.5
8526	≤ 15

### **Operational power curve**

The DC load's output follows a power curve illustrated below:

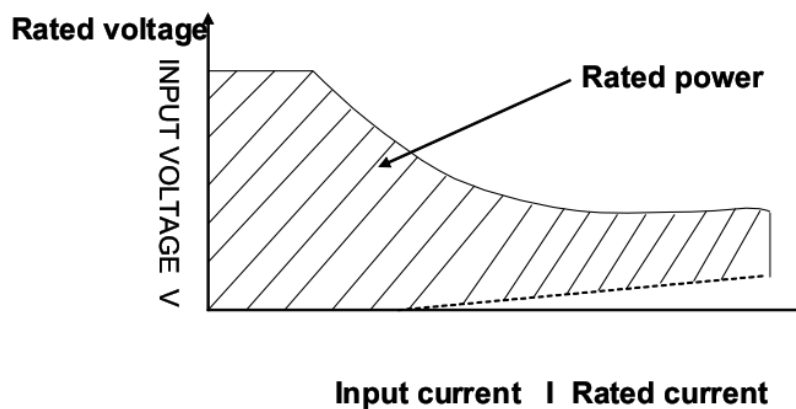

The curved portion is where the dissipated power is at the rated power of the instrument (and is actually a hyperbolic shape). When you use the menu to set lower-than-maximum power or current, the operating region may look like the following:

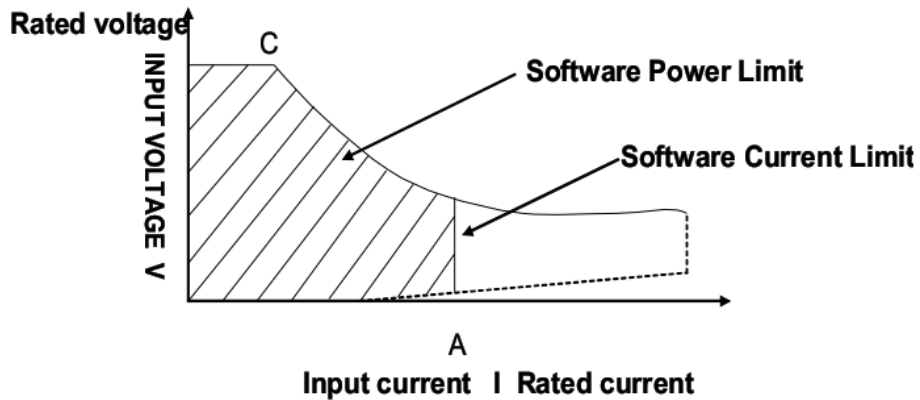

Note the gap between the operating region and the current axis for lower voltages. More detail is described in the following section.

### Low Voltage Characteristics

The following graphs show the voltage/current relationships for low voltages:

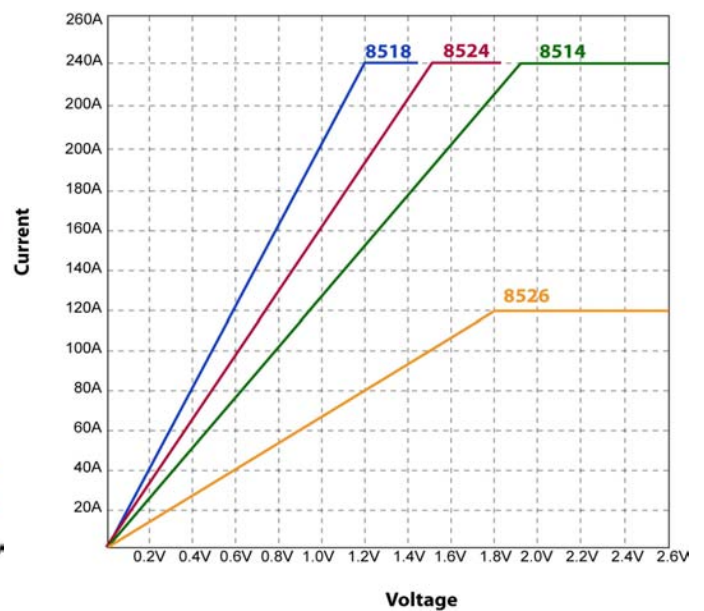
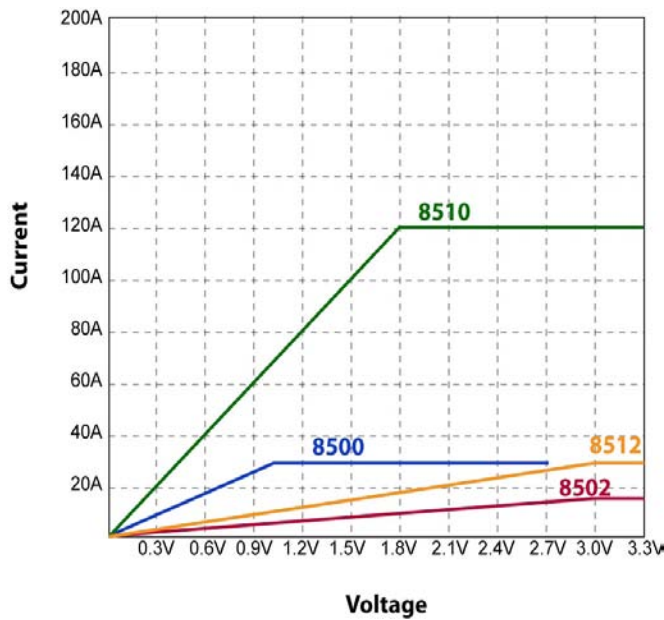

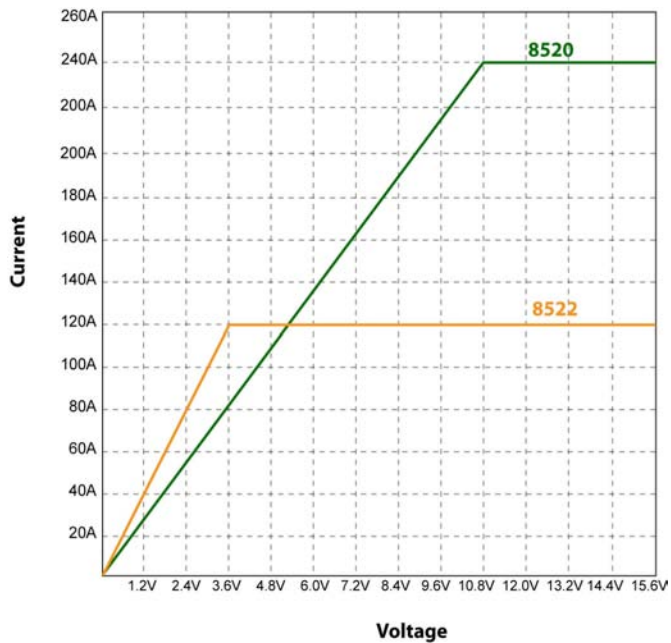

### Slew rate

The slew rate for each DC load varies from model to model. The variations are also dependent on the different regions measured for each individual load. In general, the slew rate for low current transitions, say 0 to 0.5 A, is significantly lower than slew rate for current transitions from 30 to 70 A. The provided table below indicates measured slew rates based on the maximum range of current transition of the models are capable of. For example, model 8500's slew rate would be measured with current transition from 0 A to 30 A.

*Note: The graph below illustrates slew rate measurements. In general, the indicated slew rates in the table below are measured based on the maximum current range each model is able to handle. Between the 10% and 90% region, the slew rate can be measured by observing the steepest slope portion. The indicated measured time would be used to calculate the slew rate. Hence, the slew rate calculation is simply (rated max. current – 0 A) / T, where T is the measured time from 10% to 90% region and rated max. current is the specified maximum current of each load.*

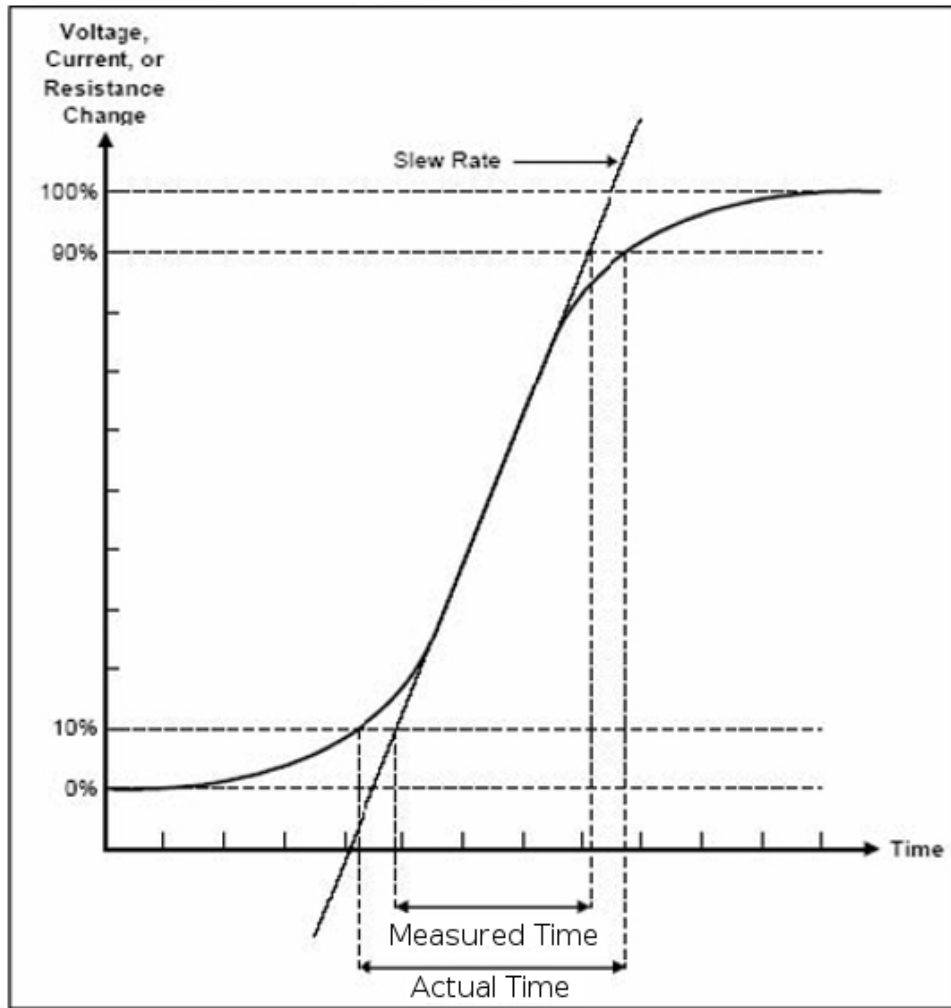

As a reference, below is a table of slew rates for their respective models:

Model	Slew rate
8500	$0.5A/\mu S$
8502	$0.5A/\mu S$
8510	$1A/\mu S$
8512	$0.5A/\mu S$
8514	$1A/\mu S$
8518	$1A/\mu S$
8520	$1A/\mu S$
8522	$1A/\mu S$
8524	$1A/\mu S$
8526	$1A/\mu S$

## Glossary

<b>△</b>	Up arrow key. Used to scroll through the menu or cause the temporary display of the alternate standard display.
<b>▽</b>	Down arrow key. Used to scroll through the menu or cause the temporary display of the alternate standard display.
<b>A</b>	Value for first setting of transient mode.
<b>B</b>	Value for second setting of transient mode.
Battery	Select battery testing mode. See <b>Battery test</b> section.
CC	Constant current
Condition	Steady state, transient, or dynamic. Steady state condition means the load mode is operated in a steady state. Transient condition means the load mode is switched between two values with user-selectable timing. Dynamic means multiple levels and timings are available (and are gotten by using lists).
CR	Constant resistance
CV	Constant voltage
CW	Constant power
Dynamic condition	See Condition.
<b>Enter</b>	Choose the indicated value or setting.
<b>Esc</b>	Stop current entry and go to previous menu level.
<b>I-set</b>	Configure the instrument for constant current mode.
Knob click	Press the knob in until it clicks. This is an alternate method for changing settings.
Link	This annunciator will light up when communications are coming in across the serial interface. It will stay lit for approximately 3 seconds after the last command was received.
List	A list is a stored sequence of test parameter and test duration values. These are used for dynamic load profiles.
<b>Local</b>	Returns control to the front panel.
Menu	Show the top level item of the instrument's menus.
Mode	Mode of operation of the instrument. The four modes are CC, CV, CW, and CR.
Mode settings	Parameter values for CC, CV, CW, and CR modes.
<b>On/Off</b>	Manually toggle the instrument between its set mode and an infinite impedance state.
<b>P-set</b>	Configure the instrument for constant power mode.
Power	Power switch to turn the instrument on and off.

<b>R-set</b>	Configure the instrument for constant resistance mode.
<b>Recall</b>	Recall instrument state from non-volatile memory.
Remote sensing	Allows the instrument to measure the load power properly in case of large currents by sensing the voltage at the source, rather than at the instrument's terminals. This removes the effect of the resistance of long leads.
<b>S-Tran</b>	Set parameters (A, B, and transition times) for transient mode.
<b>Shift</b>	Shift key, which allows access to the functions written beneath the number keys.
<b>Short</b>	Toggles between normal operation and a low resistance short.
<b>Store</b>	Allows the user to save the instrument state in non-volatile memory.
Test file	A sequence of different test modes used for automated testing.
<b>Tran</b>	Set to transient condition.
Transient condition	See Condition.
<b>Trigger</b>	The key that causes an immediate trigger.
<b>V-set</b>	Configure the instrument for constant voltage mode.
VFD	Vacuum fluorescent display, the technology used for the instrument's display.

# Installation

## Inspection

### *Items you should have received*

When you open the box containing the instrument, you should find the following items:

1. The DC Load instrument
2. Power cord
3. User manual
4. Installation CD with application software PV8500
5. TTL to RS-232 serial converter IT-E131
6. Calibration report

## Instrument location

This instrument is intended for indoor use in a pollution degree 2 environment. Please refer to the specifications table for the allowable environment operating limits.

Significant power may be dissipated in the DC Load, which includes one or more thermostatically-operated fans. The fans draw air through the bottom and sides and exhaust it out the back. It is important to allow at least 25 mm (1 inch) of clearance on all sides of the instrument so adequate cooling airflow can be maintained.

### **CAUTION**

Do not block the fan exhaust at the rear of the load.

## Outline Drawings

All dimensions are in millimeters (mm).

### **Models: 8500& 8502**

**Dimension** :214.5mmW x 88.2mm H x 254.6mm D

Terminal length: 29.4mm

Feet height:17.5mm

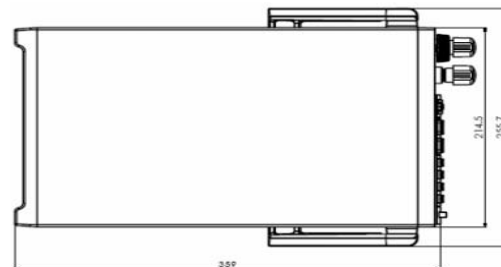
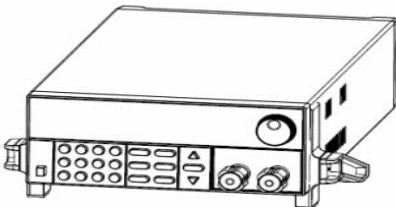
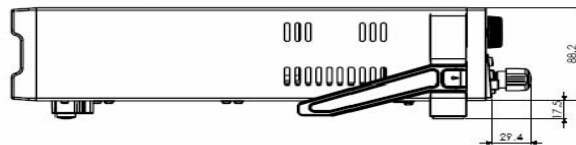
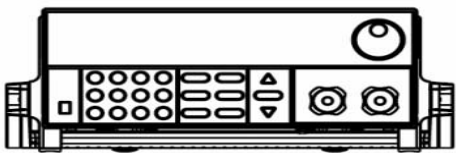

**Outline Diagram**      **Unit (mm)**

**Models 8510, 8512, 8514 & 8518**

**Dimension :429mmW x88.2mm H x 354.6mm D**

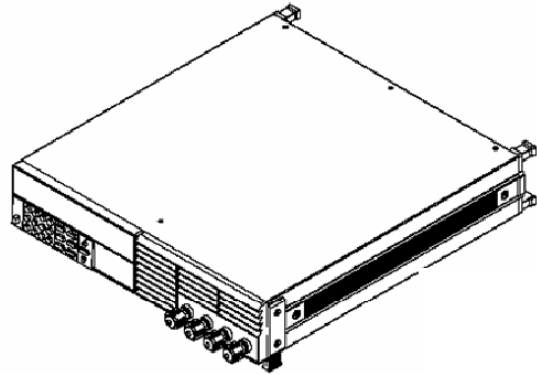
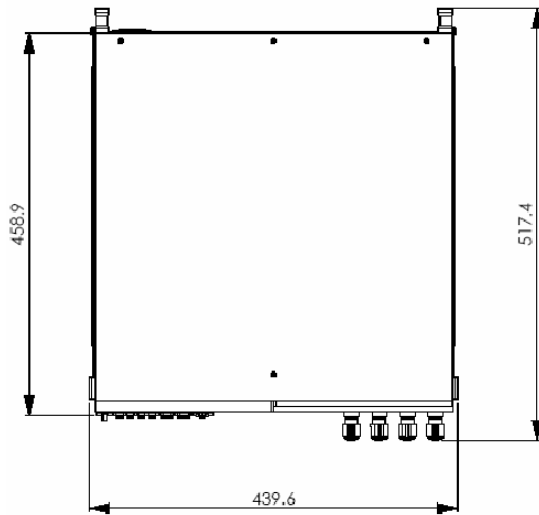
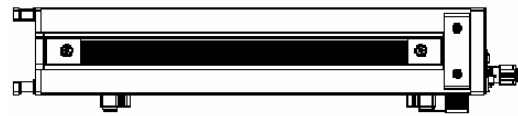
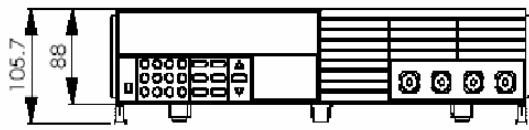

**Outline Diagram      Unit (mm)**

**Models 8520, 8522**

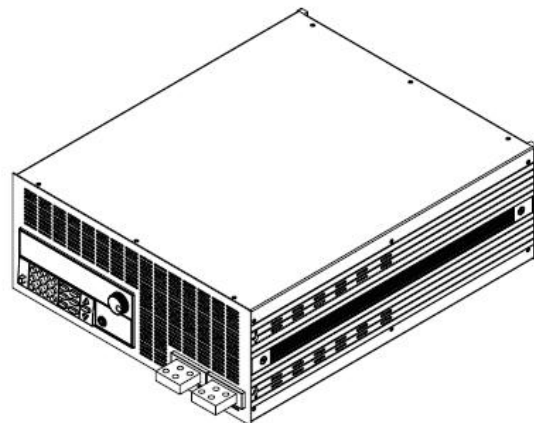
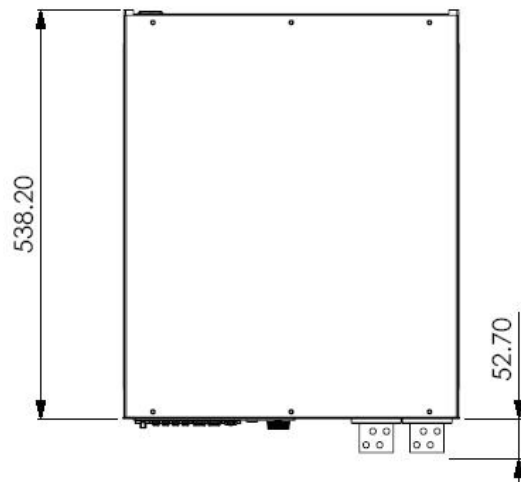
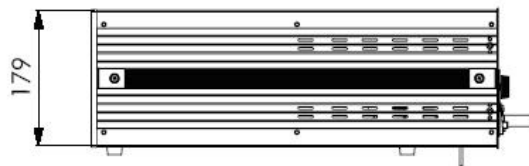
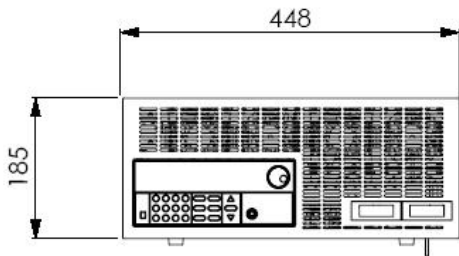

**Models 8524 & 8526**  
Unit (mm)

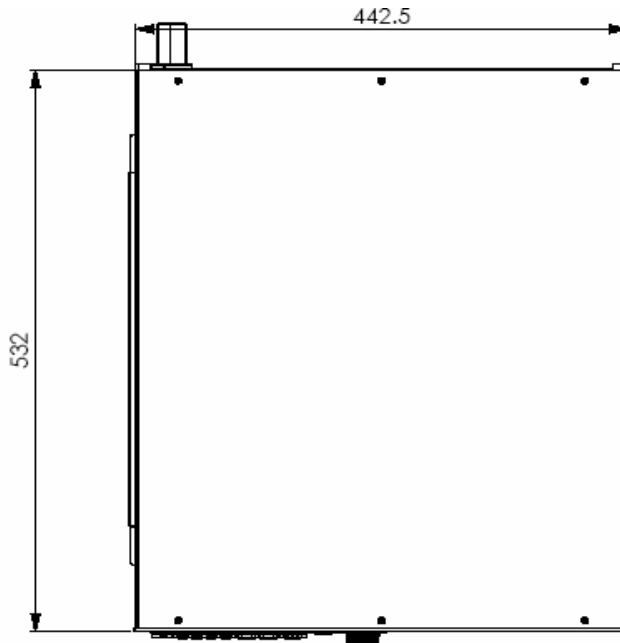
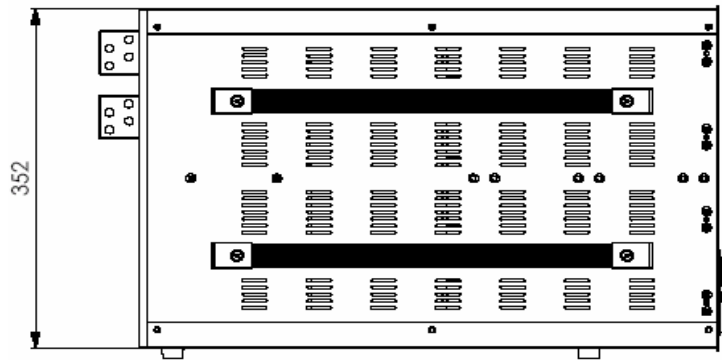
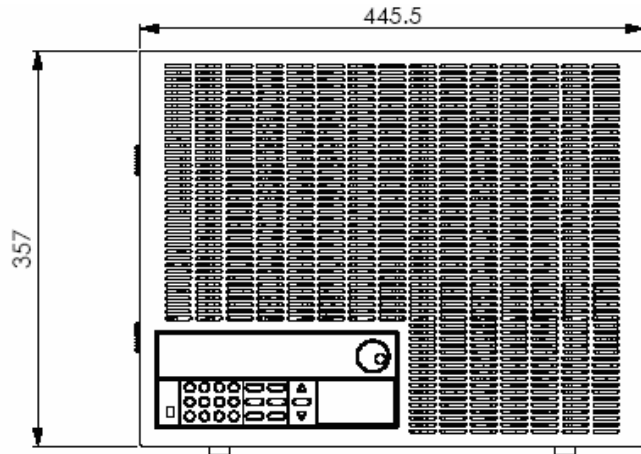

Model number	Dimensions in mm	Mass in kg
8500	215W×88H×355D	5.2
8502	215W×88H×355D	5.2
8510	429W×88H×355D	14
8512	429W×88H×355D	14
8514	429W×88H×355D	14
8518	429W×88H×355D	14
8520	444W×180H×539D	30
8522	444W×180H×539D	30
8524	444W×357H×539D	67
8526	490W×357H×539D	67

## Bench operation

The 8500 DC Load is provided with a carrying handle. The following pictures demonstrate various ways to use the handle.

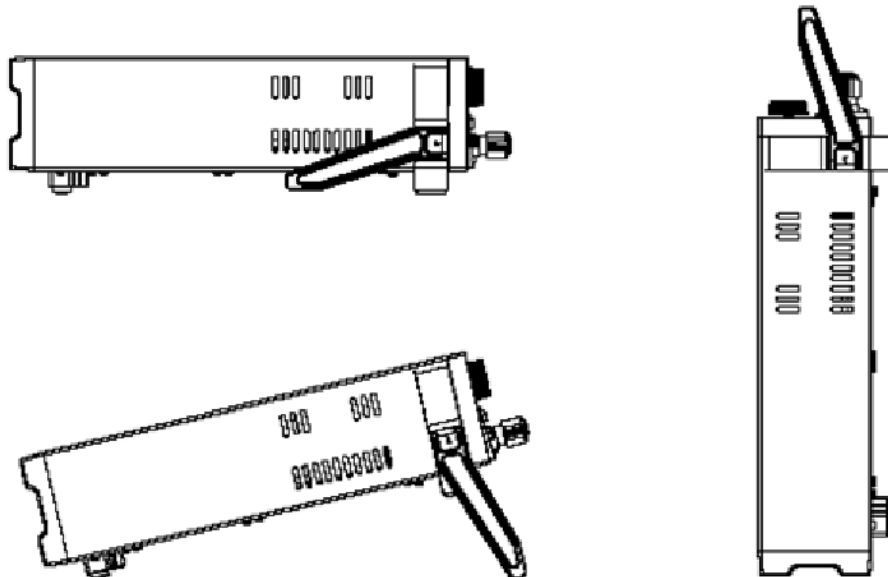

The handle may be removed if desired. A rack mounting kit (IT-E151) is also available.

## First turn-on checkout

### CAUTION

Ensure that the line voltage selector switch on the back panel is set to match your line voltage. Failure to do so could result in damage to the instrument.

Connect an appropriate IEC power cord to the DC Load and plug the power cord into an AC power outlet. Ensure that nothing is connected to the INPUT terminals. Turn the instrument on by pushing the Power button in. The instrument should display **SYSTEM SELFTEST**, then display **0.00V 0.000A**. A small annunciator will display **OFF** in the upper left corner of the display. If you do not see this display, please consult the *In case of trouble* chapter.

The following test will verify the DC Load can operate properly in constant current mode. Press the **I-set** button (you may have to press it twice) and use the numeric keypad to set the current to 0.1 A. To do this, press **.** (the decimal point), **1**, **Enter**. Alternatively, you can adjust the current level with the knob, then click the knob or press **Enter**.

Connect a power supply or battery to the DC Load, observing the polarity. Turn the power supply on and set a voltage of 1 volt. On the DC Load, press the **On/Off** button. You should see approximately 0.1 A of current flowing as shown by the instrument's ammeter and approximately 1 volt. The **CC** annunciator should be displayed, showing that the instrument is in the constant current mode.



The instrument's voltage display may read a bit less than the power supply's output -- this may be due to a voltage drop in the wires connecting the power supply to the DC Load. Press the  $\Delta$  or  $\nabla$  keys to see the power that is being consumed by the load.



Press the **V-set** button (you may have to press it twice). Note the load is turned off. Set the power supply to 10V and the supply's current to a very low level, e.g. 0.1 A. Set the DC Load voltage level well below the supply voltage level, e.g. 1 V. Press the **On/Off** key. Verify the proper voltage level (1 V) is shown on the display. Press the  $\Delta$  or  $\nabla$  keys to see the power being dissipated.

Press the **P-set** button (you may have to press it twice). Note the load is turned off. Set the power level to 0.1 watt. Press the **On/Off** key. Press the  $\Delta$  or  $\nabla$  keys to verify that the power is about 0.1

watt.

Press the **R-set** button (you may have to press it twice). Set the resistance to 100  $\Omega$ . Press the **On/Off** key. Verify that the current is approximately the displayed voltage in V divided by 100.

You can cycle between the four modes by pressing the **I-set**, **V-set**, **P-set**, and **R-set** buttons. Note that the previously-set values are remembered.

If the instrument worked as explained above, you've demonstrated that the four operating modes of the instrument are working. Please refer to the next section for detailed operation instructions.

## Operational introduction

There are four operational modes of the instrument: constant current, constant voltage, constant power, and constant resistance (we will abbreviate these as CC, CV, CW, and CR, respectively). These are selected by the **I-set**, **V-set**, **P-set**, and **R-set** buttons, respectively. If you press a mode button different than the currently set mode, the load will be set to **OFF** and the newly selected mode's setting will be displayed for about 3 seconds. Pressing the same mode button again will prompt for the new constant value for the selected mode.

There are three operational conditions for the instrument in these modes: steady state, transient, and dynamic.

Condition	Behavior
Steady state	The selected mode parameter is maintained at a constant value. For example, if you selected constant current mode and set the current value to 1 A, the instrument would maintain this current indefinitely when the load is <b>ON</b> .
Transient	There are two mode parameters and the load switches between these two settings with user-specified timing. An example of a transient load in constant resistance mode would be a load of 10 $\Omega$ for 1 second and 20 $\Omega$ for 3 seconds.
Dynamic	Similar to the transient condition, but capable of emulating more complex time-dependent loads. The dynamic condition uses lists to specify the time-dependent behavior.

Examples of the three conditions of operation are illustrated in the following diagram:

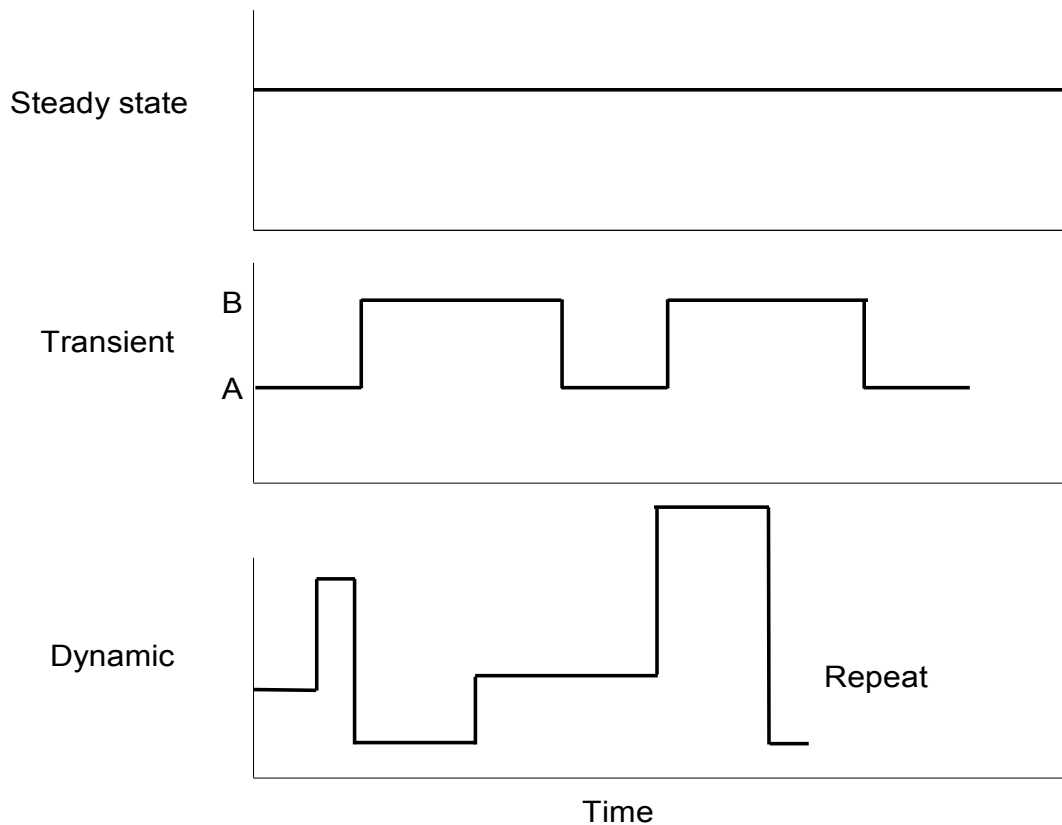

## Power-on state

The default power-on instrument state is to not remember the instrument mode settings before the last power-down. If you wish to have the mode settings remembered across a power-down, power-up cycle, use the following keystrokes:

Key	Display
<b>Shift + Menu</b>	<b>:CONFIG</b>
<b>Enter</b>	<b>:INITIAL CONFIG</b>
▼	<b>:INPUT RECALL</b>
▼	<b>:POWER-ON RECALL</b>
<b>Enter</b>	<b>:OFF &lt;DEFAULT&gt;</b>
▼	<b>:ON</b>
<b>Enter</b>	<b>:POWER-ON RECALL</b>
<b>Esc</b>	<b>:CONFIG</b>
<b>Esc</b>	Standard voltage/current display

## Constant current mode

In constant current mode, the DC load will sink a constant current, regardless of the voltage at its terminals. To set up the DC Load to operate in constant current mode and in the steady state condition, use the following keystrokes:

Key	Display
<b>I-set</b>	If you press this key after powering up and there is no currently-stored constant current value, you'll be prompted for the desired current level. If there was a current value already stored, it will be momentarily displayed and the instrument will be in CC mode. If you wish to change the current setting, press <b>I-set</b> again. The <b>OFF</b> annunciator will be displayed.
<b>On/Off</b>	Turns the constant current load on. The <b>CC</b> annunciator will be on.
<b>△ or ▽</b>	Momentarily display the power level and the set current value.
<b>On/Off</b>	Turns the load off.

To operate the DC Load in CC mode in a transient condition, see the **Transient operation** section. To operate the DC Load in CC mode in a dynamic condition, see the **Lists** section.

## Constant voltage mode

In constant voltage mode, the DC load will cause a constant voltage to appear at its terminals. To set up the DC Load to operate in constant voltage mode and in the steady state condition, use the following keystrokes:

Key	Display
<b>V-set</b>	If you press this key after powering up and there is no currently-stored constant voltage value, you'll be prompted for the desired voltage level. If there was a voltage value already stored, it will be momentarily displayed and the instrument will be in CV mode. If you wish to change the voltage setting, press <b>V-set</b> again. The <b>OFF</b> annunciator will be displayed.
<b>On/Off</b>	Turns the constant voltage load on. The <b>CV</b> annunciator will be on.
<b>△ or ▽</b>	Momentarily display the power level and the set voltage value.
<b>On/Off</b>	Turns the load off.

To operate the DC Load in CV mode in a transient condition, see the **Transient operation** section. To operate the DC Load in CV mode in a dynamic condition, see the **Lists** section.

## Constant power mode

In constant power mode, the DC load will cause a constant power to be dissipated in the load. To set up the DC Load to operate in constant power mode and in the steady state condition, use the following keystrokes:

Key	Display
<b>P-set</b>	If you press this key after powering up and there is no currently-stored constant power value, you'll be prompted for the desired

Key	Display
	power level. If there was a power value already stored, it will be momentarily displayed and the instrument will be in CW mode. If you wish to change the power setting, press <b>P-set</b> again. The <b>OFF</b> annunciator will be displayed.
<b>On/Off</b>	Turns the constant power load on. The <b>CW</b> annunciator will be on.
<b>△ or ▽</b>	Momentarily display the power level and the set power value.
<b>On/Off</b>	Turns the load off.

To operate the DC Load in CW mode in a transient condition, see the **Transient operation** section.  
 To operate the DC Load in CW mode in a dynamic condition, see the **Lists** section.

## Constant resistance mode

In constant resistance mode, the DC load will behave as a fixed resistance value. To set up the DC Load to operate in constant resistance mode and in the steady state condition, use the following keystrokes:

Key	Display
<b>R-set</b>	If you press this key after powering up and there is no currently-stored constant resistance value, you'll be prompted for the desired resistance. If there was a resistance value already stored, it will be momentarily displayed and the instrument will be in CR mode. If you wish to change the resistance setting, press <b>R-set</b> again. The <b>OFF</b> annunciator will be displayed.
<b>On/Off</b>	Turns the constant resistance load on. The <b>CR</b> annunciator will be on.
<b>△ or ▽</b>	Momentarily display the power level and the set resistance value.
<b>On/Off</b>	Turns the load off.

To operate the DC Load in CR mode in a transient condition, see the **Transient operation** section.  
 To operate the DC Load in CR mode in a dynamic condition, see the **Lists** section.

## Timed operation

The DC Load can be set to allow timed operation. When you turn the load on, it stays on for the specified time, then turns itself off.

To set up timed operation, use the following keystrokes:

Key	Display
<b>Shift + Menu</b>	<b>:CONFIG</b>
<b>△ △</b>	<b>:LOAD ON TIMER</b>

Key	Display
<b>Enter</b>	<b>:TIMER STATE</b>
<b>Enter</b>	Use arrow keys to set to <b>:ON</b> .
<b>▽</b>	<b>:TIMER SET</b>
<b>Enter</b>	<b>TIMER=XXXXXS</b> Enter desired time interval. Valid values are 1 to 60000 seconds (1000 minutes).
<b>Enter</b>	<b>:TIMER SET</b>
<b>Esc Esc</b>	Standard display

Now, when you turn a load on, it will stay on for the designated time, then turn off.

To turn off timed operation, enter the menu **:CONFIG:LOAD ON TIMER:TIMER STATE** and set it to **:OFF**.

## Changing display resolution

The DC Load has two ranges of current and voltage (see the specifications). You can enable higher resolution for voltages and currents on the lower range. Enter the menu with **Shift + Menu** and set the menu element **:CONFIG:RANGE SELECT** to **ON**.

### Increasing current resolution

To increase the current resolution (and change to the lower range), press **Shift + ▽**. If the DC Load is sinking a current higher than the top end of the lower range, it will be reset to the top end of the lower range. To change back to the lower current resolution, press **Shift + ▽** again.

### Increasing voltage resolution

To increase the voltage resolution (and change to the lower range), press **Shift + △**. You may see **OVERVOLTAGE** message on the display if the voltage is too high. To change back to the lower voltage resolution, press **Shift + △** again.

## Short

When a test mode is on, you may press **Shift + Short** to emulate a short. This will draw maximum current from the DC supply in any of the four operation modes (CC, CV, CW, or CR). In CC, CV, or CR mode, you may press **Shift + Short** to stop the short. The DC Load will return to its previous operation. However, in CW mode, the short current will continue to be drawn; to stop the short, you must press the **On/Off** key.

**Note:** When emulating a Short while in CV mode, the current software limit may trigger the DC load Input to turn Off, provided the current limit is reached. This does not affect the programmed settings and the DC load will restore the previously programmed values once the Short condition is removed.

## Battery test

The battery test feature measures the time it takes for a battery voltage to drop to a specified value while drawing a constant current from the battery. When the voltage at the DC Load's terminals reaches the specified voltage, the test is ended and the integrated current (i.e., charge supplied by

the battery) in ampere\*hours (A\*hrs) of the battery is calculated and displayed. To run a battery test, follow these steps:

Key presses	Display
<b>I-set</b> , enter current value with numerical keys, then press <b>Enter</b> .	Set the DC Load to constant current mode and set the current you want to draw from the battery. (You may have to press the <b>I-set</b> key twice to be able to set the current value.)
<b>Shift + Battery</b>	<b>MIN VOLT= 0.10V</b> This indicates you're being asked for the voltage level where the battery test will be over.
Enter voltage level and press <b>Enter</b> .	When you press Enter, the test will start. The <b>CC</b> annunciator will be on.
$\Delta$ or $\nabla$	Shows the power level and the ampere*hours (A*hrs) accumulated so far.
When the battery voltage drops below the specified value, the test will turn off and you will see the <b>OFF</b> annunciator.	
$\Delta$ or $\nabla$	Display the total charge delivered by the battery in ampere*hours (A*hrs).
<b>Shift + Battery</b>	Turns battery testing mode off.

NOTE: you must make sure that you press **Shift + Battery** at the end of the test. Otherwise, the instrument will not respond to any key presses except  $\Delta$  or  $\nabla$ .

## Transient operation

The transient condition allows switching between two different load values. There are three different types of transient operation.

### Continuous transient operation

In continuous transient operation, the load is continuously switched between two load values. An example is shown in the following figure:

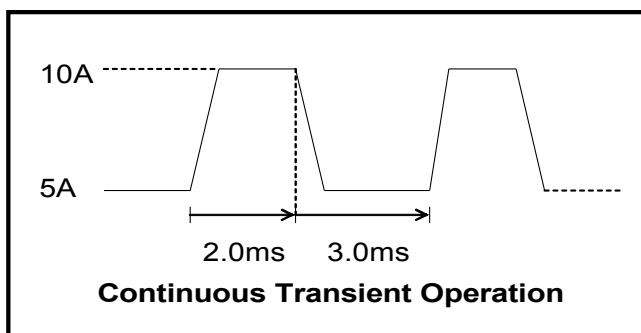

Note that this transient behavior works with any of the operation modes CC, CV, CW, or CR. Here are the keystrokes used to setup this continuous transient condition:

Keys	Display
<b>I-set</b>	Standard display of voltage and current (or, you'll be asked to enter a current value).

Keys	Display
<b>Shift + S-Tran</b>	<b>LEVEL A= X.XXXA</b> You are being prompted for the first current value. Press the <b>5</b> key for 5 A.
<b>Enter</b>	Enters the 5 A value, then displays <b>WIDTH A = X.XMS</b> . You're being prompted for the duration of the 5 A load -- press the <b>3</b> key for 3 ms.
<b>Enter</b>	Enters the 3 ms value, then displays <b>LEVEL B= X.XXXA</b> . You are being prompted for the second current value. Press the <b>1</b> and <b>0</b> keys to enter 10 A.
<b>Enter</b>	Enters the 10 A value, then displays <b>WIDTH B = X.XMS</b> . You're being prompted for the duration of the 10 A load -- press the <b>2</b> key for 2 ms.
<b>Enter</b>	Enters the 2 ms duration, then displays <b>:CONTINUOUS</b> , <b>:PULSE</b> , or <b>:TOGGLED</b> . Use the $\Delta$ or $\nabla$ arrow keys to display <b>:CONTINUOUS</b> .
<b>Enter</b>	Returns to the standard display of voltage and current.

To activate this continuous transient condition, press **Shift + Tran**, then press **On/Off**. The load will begin switching between the two Tran values with the timing you entered.

### Pulse transient operation

In pulse transient operation, the load operates at the A value that has been entered until a trigger is received. At the trigger, the load switches to the B value and stays at that level for the B timing value. Then the load switches back to the A value and stays there until another trigger is received. Here's an example:

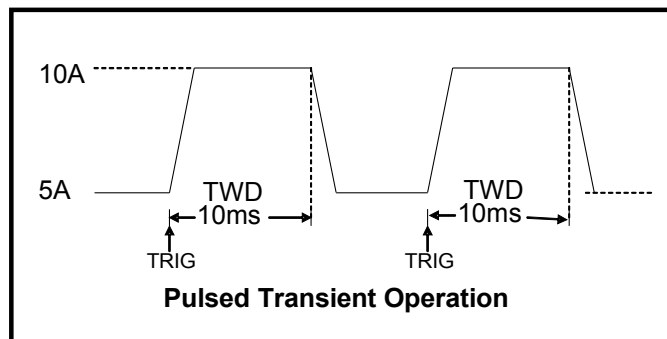

Here are the keystrokes needed to set up this example:

Keys	Display
<b>I-set</b>	Standard display of voltage and current (or, you'll be asked to enter a current value).
<b>Shift + S-Tran</b>	<b>LEVEL A= X.XXXA</b> You are being prompted for the first current value. Press the <b>5</b> key for 5 A.
<b>Enter</b>	Enters the 5 A value, then displays <b>WIDTH A = X.XMS</b> . You're being prompted for the duration of the 5 A load. In the pulse mode of operation, this width is ignored, so enter any convenient value.
<b>Enter</b>	Displays <b>LEVEL B= X.XXXA</b> . You are being prompted for the second

Keys	Display
	current value. Press the <b>1</b> and <b>0</b> keys to enter 10 A.
<b>Enter</b>	Enters the 10 A value, then displays <b>WIDTH B = X.XMS</b> . You're being prompted for the duration of the 10 A load -- press the <b>1</b> and <b>0</b> key for 10 ms.
<b>Enter</b>	Enters the 10 ms duration, then displays <b>:CONTINUOUS</b> , <b>:PULSE</b> , or <b>:TOGGLED</b> . Use the <b>▲</b> or <b>▼</b> arrow keys to display <b>:PULSE</b> .
<b>Enter</b>	Returns to the standard display of voltage and current.

To activate this pulse transient condition, press **Shift + Tran**, then press **On/Off**. The load will start at the A level of current you entered (5 A). Press **Shift + Trigger** to cause the load to switch to the B level of current (10 A). The 10 A current will last for the designated 10 ms, then switch back to the A level (5 A).

NOTE: This example requires the **:CONFIG:TRIGGER** menu item be set to **:IMMEDIATE**. If set to **:EXTERNAL**, you'd trigger the instrument with a high TTL level signal on the trigger terminals on the rear panel. If set to **:BUS**, you'd trigger the instrument with a software trigger.

### Toggled transient operation

In toggled transient operation, the load starts at the stored parameter for the mode. When a trigger is received, the load switches to the B value. When another trigger is received, the load switches to the A value. It stays at the A value until another trigger is received, at which point it switches to the B value. Further triggers cause the load to switch between the A and B values. Here's an example:

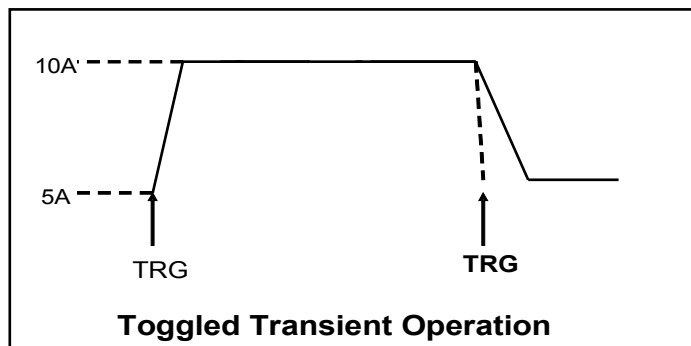

Here are the keystrokes needed to setup this example:

Keys	Display
<b>I-set</b>	Standard display of voltage and current. Enter a value of 5 A (you may need to press the <b>I-set</b> key again). Press Enter.
<b>Enter</b>	Enters the CC mode's value. The standard display is shown.
<b>Shift + S-Tran</b>	<b>LEVEL A = X.XXXA</b> You are being prompted for the first current value. Press the <b>5</b> key for 5 A.
<b>Enter</b>	Enters the 5 A value, then displays <b>WIDTH A = X.XMS</b> . You're being prompted for the duration of the 5 A load. In the toggled mode of operation, this width is ignored, so enter any convenient value.

Keys	Display
<b>Enter</b>	Displays <b>LEVEL B= X.XXXA</b> . You are being prompted for the second current value. Press the <b>1</b> and <b>0</b> keys to enter 10 A.
<b>Enter</b>	Enters the 10 A value, then displays <b>WIDTH B = X.XMS</b> . You're being prompted for the duration of the 10 A load. . In the toggled mode of operation, this width is ignored, so enter any convenient value
<b>Enter</b>	Displays <b>:CONTINUOUS</b> , <b>:PULSE</b> , or <b>:TOGGLED</b> . Use the $\Delta$ or $\nabla$ arrow keys to display <b>:TOGGLED</b> .
<b>Enter</b>	Returns to the standard display of voltage and current.

To activate this toggled transient condition, press **Shift + Tran**, then press **On/Off**. The load will start at the value you entered for A (5 A). Then press **Shift + Trigger** to cause the load to switch to the B level of current (10 A). The next trigger will cause the load to shift back to the A level (5 A). Subsequent triggers repeat this behavior.

NOTE: This example requires the **:CONFIG:TRIGGER** menu item be set to **:IMMEDIATE**. If set to **:EXTERNAL**, you'd trigger the instrument with a high TTL level signal on the trigger terminals on the rear panel. If set to **:BUS**, you'd trigger the instrument with a software trigger.

### ***Toggle between two test values***

When you have entered A and B values through the **Shift + S-Tran** menu, those values are available to you at the front panel. Suppose you set the instrument to operate in CC mode at a current of 1 A. If the transient A level was 5 A and the transient B level was 10 A, you can set the instrument to the A level by pressing **Shift + A**. The load has to be on and cannot be in transient condition (i.e., the **TRAN** annunciator must not be lit). Otherwise, the A value will be stored as the CC mode's current. Similarly, **Shift + B** causes the B value to be stored as the CC mode's current. The load can be on or off for this to work.

### **Lists (dynamic condition)**

Transient operation is used for simple step changes in load values. More complicated dynamic behavior of the load can be obtained through the use of lists. Lists are a sequence of load value and duration pairs. Lists are the logical extension of transient operation.

To illustrate the use of a list, we'll create a list that runs the following constant current profile on a power supply:

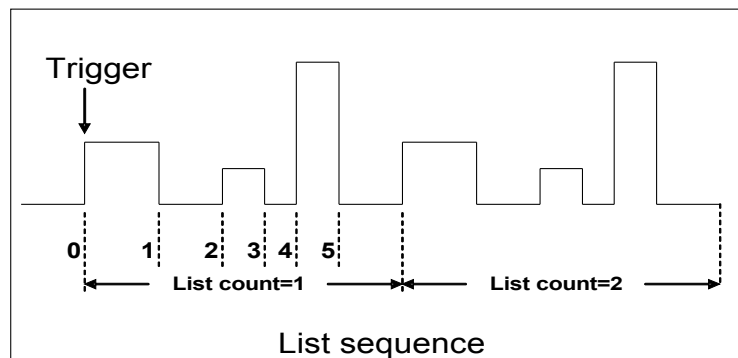

This list is characterized by the following current/duration pairs

Current, A	Duration, ms	Between times
3	1000	0 and 1
0	800	1 and 2
2	500	2 and 3
0	300	3 and 4
6	500	4 and 5

This list has 5 steps, located at the transitions 1 through 5. The first duration, 1000 ms, occurs after the triggered event. Subsequent durations are from the previous transition to the current transition.

Here are the keystrokes to set up this list:

Keys	Display
<b>Shift + Menu</b>	<b>:CONFIG</b>
▽ ▽	<b>:LIST SET</b>
<b>Enter</b>	<b>:MODE SET</b>
<b>Enter</b>	Select <b>:LIST</b> mode. This will cause the <b>LIST</b> annunciator to turn on.
<b>Enter</b>	<b>:MODE SET</b>
▽ ▽	<b>:EDIT LIST FILE</b>
<b>Enter</b>	<b>:CURRENT LIST</b>
<b>Enter</b>	Select <b>:REPEAT</b> .
<b>Enter</b>	<b>LIST COUNT= N</b> How many steps this list has. Enter the number 5.
<b>5 Enter</b>	<b>COUNT 1= X.XXA</b> Set the current for the first step. Enter 3.
<b>3 Enter</b>	<b>COUNT 1= X.XXMS</b> Set the duration for the first step. Enter 1000.
<b>1000 Enter</b>	Repeat the current and duration entry for the following 4 steps.
<b>Enter</b>	<b>STORE LIST FILE1</b> The 1 is underlined, indicating you can enter a number to specify the "file" (i.e., block of EEPROM) to store this list to. Choose a number via the keypad or the knob. You can choose any number between 1-8.
<b>Enter</b>	<b>:EDIT LIST FILE</b>
<b>Esc Esc</b>	Standard display

First, press the **On/Off** key. The load will sink the current that is stored as the CC mode parameter (set it to 0 A if you don't want an initial current). Then press Shift + Trigger to have the list start executing.

Should you wish to have the list only execute once after the trigger, you can edit the list to use **:ONCE** instead of **:REPEAT**.

To exit List mode press the **Shift** and **Trigger** key

## Test files

Test files are a generalization of lists -- they let you generate a sequence of tests using different

modes, mode parameters, and durations. They are useful for executing a set of tests on a device, then displaying whether the tests passed or failed. We will illustrate how to use test files by a short example.

Suppose we have a small AC to DC power supply (a "wall-wart") and we want to set up an acceptance test for a number of these devices. Our test will consist of two steps:

1. Set the DC load to constant current mode to draw the rated current of 0.35 A from the device. The output voltage of the device at the rated current must be between 4.4 volts and 4.6 volts.
2. When the device operates into a short, the supplied current must be larger than 2.0 A.

Keys	Display
<b>Shift + Menu</b>	<b>:CONFIG</b>
<b>▽ ▽</b>	<b>:LIST SET</b>
<b>Enter</b>	<b>:MODE SET</b>
<b>▽ ▽ ▽ ▽</b>	<b>:EDIT TEST FILE</b>
<b>Enter</b>	<b>MAX CURR= 3.000A</b> Set the maximum current to 2.5 A
<b>2.5 Enter</b>	<b>MAX VOLT= 18.00V</b> Set the maximum voltage to 5 V
<b>5 Enter</b>	<b>MAX POWER= 150.00W</b> Set the maximum power to 15 W
<b>15 Enter</b>	<b>TEST COUNT= 6</b> Our test will consist of two steps, so we enter 2. You can enter up to 20 steps.
<b>2 Enter</b>	<b>CONST CURRENT</b> Since our first test is in constant current mode, we'll just press Enter to select this mode.
<b>Enter</b>	<b>SET 1= 0.210A</b> This is the prompt for the constant current value. We set it to 0.35 A.
<b>.35 Enter</b>	<b>SHORT OFF</b> We can turn a short on or off at this step. Here, we want short off, so we just press Enter.
<b>Enter</b>	<b>READBACK V</b> We're being prompted for what parameter to read back and check. We want voltage, so we press Enter.
<b>Enter</b>	<b>MIN 1= 5.80V</b> We want the minimum voltage read back to be at least 4.4 V.
<b>4.4 Enter</b>	<b>MAX 1= 6.15V</b> The maximum value we'll allow is 4.6 V.
<b>4.6 Enter</b>	<b>DELAY 1= 1.0&lt;S&gt;</b> This delay time is how long to wait before making the readback measurement. If you set it to 25.5 seconds, the test will halt at this point, requiring you to press Shift + Trigger to continue the test. We'll use 1 second.
<b>1 Enter</b>	<b>CONST CURRENT</b> We're being prompted for the mode to use for the next step. We'll again use constant current, so we'll press Enter (this step will also be a short, so the mode doesn't really matter).
<b>Enter</b>	<b>SET 2= 5.000A</b> We'll set the current to 2.5 A, which is the maximum current we've allowed for this test..

Keys	Display
2.5 Enter	<b>SHORT OFF</b> We select short on and then press Enter.
▽ Enter	<b>READBACK A</b> We want to readback the current, so we press Enter.
Enter	<b>MIN 2= 4.950A</b> Our minimum value is 2.0 A.
2 Enter	<b>MAX 2= 5.050A</b> We choose 2.5 A as the maximum value.
2.5 Enter	<b>DELAY 2= 3.0&lt;S&gt;</b> We'll wait 2 seconds for the maximum current.
2 Enter	<b>STORE TEST FILE1</b> The 1 is underlined, meaning you can choose which test file number to store this test to. You can choose any number between 1-8. Here, we will use 1, so just press Enter.
Enter	<b>EDIT TEST FILE</b>
Esc Esc	Exit the menu. The normal display is shown (V and A).

The test file has been created and saved in file position 1. Now we will run the test on the device.

Keys	Display
Shift + Menu	<b>:CONFIG</b>
▽ ▽	<b>:LIST SET</b>
Enter	<b>:MODE SET</b>
▽ ▽ ▽	<b>:CALL TEST FILE</b>
Enter	<b>RECALL 1</b> We're being prompted for which file number to recall. Since we saved to file number 1, we just press Enter.
Enter	<b>CALL TEST FILE</b> The test file is now loaded, so we return to the normal display.
Esc Esc	Exit the menu. The normal display is show (V and A).
Shift I-set	<b>NAME:TEST FILE 1</b> We've entered automatic testing mode. The display is showing which test file we're using.
Shift Trigger	This starts the test. You'll see the values sequentially displayed. Then you'll either see <b>PASS</b> or <b>FAULT</b> . You can press <b>Shift Trigger</b> again for another test run or press <b>Esc</b> to return to the normal display.
Esc	Return to the normal display.

## Triggering

Triggering is used with the transient and dynamic conditions to allow synchronization of the DC Load's behavior with other events. There are three types of triggers you may use (set in the **CONFIG:TRIGGER SOURCE** menu):

Trigger Type	Explanation
<b>IMMEDIATE</b>	An immediate trigger is created by pressing <b>Shift + Trigger</b> on the

Trigger Type	Explanation
	front panel keys.
<b>EXTERNAL</b>	An external trigger is a TTL high signal applied to the Trigger connection on the back panel. This TTL signal must last for more than 5 ms. A trigger applied to this input can be used to change settings (voltage, current , resistance), toggle between settings in transient-toggle mode, or generate a pulse in pulse mode.
<b>BUS</b>	The instrument will be triggered if a 5AH command is sent via the RS-232 interface. See the <b>Remote operation</b> section for more details.

## Voltage threshold operation

The DC Load can be set to only turn on if the voltage is at or above a set value. Additionally, the load will turn off if the voltage drops below a second set value. This feature works for any mode.

An example of use would be to ensure an electronic system under test will not have power applied unless the supply voltage is above a certain value. The DC Load would be put in series with the power supply. Remote sensing would be turned on and the remote sensing connector on the back would be used to connect to the power supply's output voltage.

Use the menu items **SYSTEM SET:VOLTAGE ON SET** and **SYSTEM SET:VOLTAGE OFF SET** to set the on and off voltage thresholds, respectively.

Example 1: set the **VOLTAGE ON SET** and **SYSTEM SET:VOLTAGE OFF SET** both to 1.0 V. Set the instrument to constant current mode with the **I-set** key and set the current level to 0.1 A. Turn the load on by pressing the **On/Off** key. When power is applied to the DC Load, the voltage must rise above 1.0 V before the load draws current from the source. If the voltage drops below 1.0 V on the load's terminals, the load will stop drawing current from the source.

Example 2: Same as the previous example, except set the **VOLTAGE ON SET** to 1.0 V and the **SYSTEM SET:VOLTAGE OFF SET** 0.0 V. As before, the load will turn on only when the voltage exceeds 1.0 V, but once it is "triggered" on, it will now stay on, even if the voltage drops to zero.

## Passwords

If you enter the menu **CONFIG:KEY LOCK SET**, you can set a one to four digit password. This password will be required when changing settings from the front panel. The only operations allowed without entering the password are:

**Shift + A**  
**Shift + B**  
**Shift + Short**  
**Shift + Tran**  
**Shift + Trigger**  
**On/Off**

To remove the password, enter the menu **CONFIG:KEY LOCK SET** and do not press any number keys, then press **Enter**.

## Protection features

To protect external hardware when using the DC Load, you can set the maximum allowed values for current, voltage, and power. These settings will override any settings subsequently made from the front panel using the **I-set**, **V-set**, **P-set**, or **R-set** keys.

To set these protection values, use the following keystrokes:

Keys	Display
<b>Shift + Menu</b>	<b>:CONFIG</b>
<b>↓</b>	<b>:SYSTEM SET</b>
<b>Enter</b>	Select between: <b>:MAX CURRENT SET</b> <b>:MAX POWER SET</b> <b>:MAX VOLTAGE SET</b> using the <b>↑</b> and <b>↓</b> arrow keys, then press <b>Enter</b> . Enter the desired value, then press <b>Enter</b> to accept it.
<b>Esc Esc</b>	Exit from the menu.

**Example:** Suppose you are measuring current vs. voltage characteristics of a 1 watt resistor. You could set the maximum allowed power to 1.1 watts to test the resistor's rating, yet not go over the maximum rating by more than 10% to ensure you don't destroy the resistor. If you tried to use the **P-set** key to set the power to more than 1.1 W, the instrument will limit the set value to 1.1 W.

### Over Voltage protection

If input voltage exceeds the voltage limit set by the user, the **DC load** will turn the input OFF and the buzzer will sound. The display will show **OVER VOLTAGE**. The maximum voltage limit value is equal to the maximum rated voltage for each model. For the over voltage protection state to be activated, the voltage level presented to the load terminal must exceed the limit set value by approximately 5%.

### Over Current protection

When operating in CR, CC or CW mode, the load current will be limited by a current limit value set by the user. The maximum current limit value is equal to the maximum rated current for each model. Once the maximum current limit is reached, the DC Load will enter the over current protection state and the current will be limited to the set value. (The input will not turn off). If the DC load previously operated CR or CW mode, the DC load will automatically revert to CC mode and the VFD display will indicate CC. When the DC load operates in a combined CV / transition mode or CV / List mode, the buzzer will sound if the input current exceeds the current limit and the display will show a flashing current value.

### Over Power protection

If the input power exceeds the power limit in the normal operation mode, the DC load will enter the over power protection state. The display will show CW.

If the input power exceeds the limit when in transition mode or list mode, the buzzer will sound and the display will flash the current value and voltage value.

### Reverse voltage protection

This feature protects the load module in case the DC input terminals are connected to a power source with reversed polarity. If a reverse voltage condition is detected, the buzzer will sound and **REVERSE VOLTAGE** will be displayed on screen.

## Over Temperature protection

If internal temperature exceeds safety limits (80°C;176°F), the Over temperature circuitry will be activated. The DC Load will turn off the input, the buzzer will sound, and the display will show **OVERHEAT**.

## Remote sensing

Remote sensing is used to counteract the effect of lead resistance. For example, if you connect a power supply to the DC Load, the voltage at the power supply's terminals will not be the same as the voltage at the DC Load's terminals if there is a current flowing because of the finite resistance from the wires. Using remote sensing, you can sense the voltage at the power supply's terminals, effectively removing the effect of the voltage drop in the connection wire.

When using remote sensing, the power displayed by the instrument includes both the power dissipated inside the instrument and the power dissipated in the leads from the power supply to the DC Load's input terminals.

To turn remote sensing on:

Keys	Display
<b>Shift + Menu</b>	<b>:CONFIG</b>
<b>Enter</b>	<b>:INITIAL CONFIG</b>
<b>▽ 8 times</b>	<b>:REMOTE SENSE</b>
<b>Enter</b>	<b>:OFF DEFAULT </b>
<b>▽</b>	<b>:ON</b>
<b>Enter</b>	<b>:REMOTE SENSE</b> and annunciator shows <b>Sense</b> .
<b>Esc Esc</b>	Exit from the menu.

The following diagram shows the remote sensing terminals on the back of the instrument:

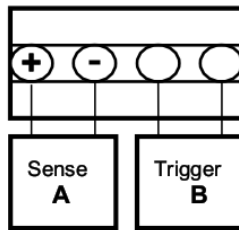

The following shows a wiring diagram for remote sensing:

### Wiring diagram for remote sense

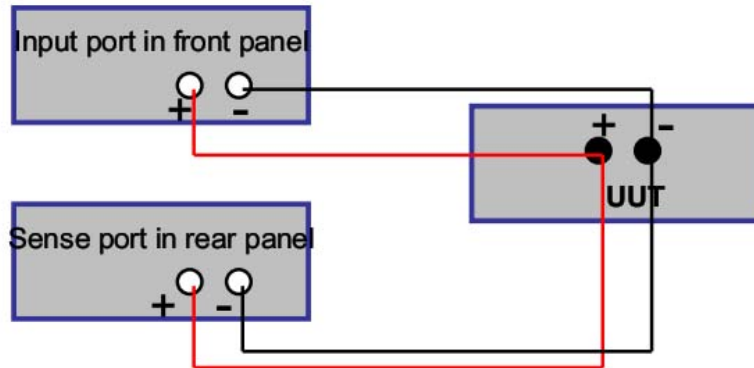

Example: A power supply is connected to the DC load with 72.5 cm of 20-gauge solid copper wires. The constant current  $i$  is set to 5 A. The power supply's output meter reads 27.0 V and the DC Load's voltage display reads 26.71 V with a power dissipation of 133.70 W. This is without remote sensing enabled. With remote sensing turned on and the remote sensing terminals connected to the power supply output terminals, the DC Load reads 26.98 V and indicates 134.95 W of power dissipation. This demonstrates that  $(134.95 - 133.70) = 1.25$  W is dissipated in the 20-gauge wires. From the resistance per unit length of 20-gauge wires, the expected dissipated power at 5 A can be calculated as 1.21 W.

### Saving and Recalling settings

The DC Load provides 25 non-volatile registers to save instrument settings for recall later.

To save the instrument's settings to a register, press **Shift + Store**. You'll be prompted for a register number. Enter a number between 1 and 25, then press the **Enter** key. The settings are saved. Note that this will overwrite any values previously saved in that register.

To recall the instrument's settings from a register, press **Shift + Recall**. You'll be prompted for a register number. Enter a number between 1 and 25, then press the **Enter** key. The stored settings are saved. Note that this will overwrite all values currently set in the instrument.

If you try to recall a register with no data in it, you will get a **NO EEPROM DATA** error message.

## Remote operation

### Communication cables

The DC Load has a DB9 connector on the rear panel that allows remote communication.

#### **WARNING**

Do not connect the DC Load's DB9 connector to a standard RS-232 instrument. Doing so may damage the instrument, as the instrument requires TTL logic signals, not standard RS-232 voltages.

Two adapters are available to perform the correct level shifting.

#### **RS232 to TTL serial converter cable IT-E131 (standard)**

Connect the INSTRUMENT side of the adapter to the DC load DB9 connector. Connect the COMPUTER end to an RS-232 port on your computer.

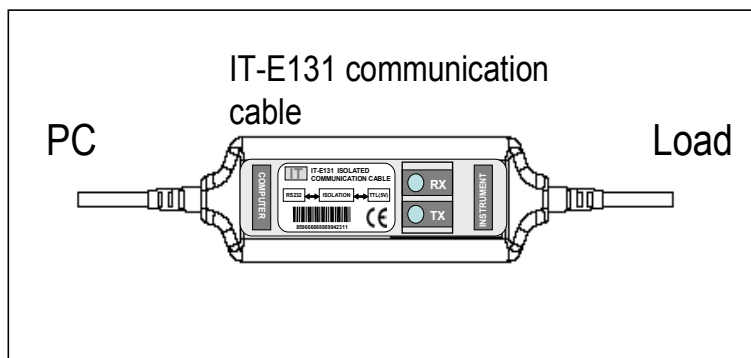

The LEDs in the adapter will blink when information is sent through the adapter. This is a good way to tell if your communication link is active.

#### **USB to TTL serial converter cable IT-E132 (option)**

The IT-E132 adapter allows you to talk to the DC load via your Windows® computer's USB interface. To use this interface, you must install the software driver that came with the IT-E132 adapter.

To install the driver, run the **PL-2303 Driver Installer.exe** file that comes on the CD. This will install the driver. After installation, right click on **My Computer** and select **Manage**. Click on Device Manager in the left-hand pane, then click on Ports in the right hand pane. You should see an entry named **Prolific USB-to-Serial Comm Port**.

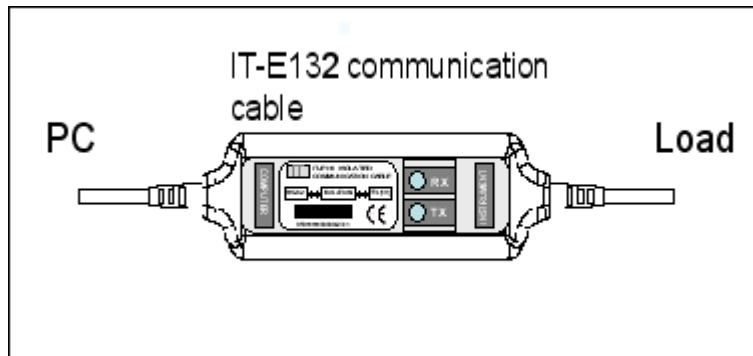

Once the driver software is installed on your system, it will appear as if you have a new COM port.

This COM port can then be accessed as if it were a regular RS-232 port.

The LEDs in the adapter will blink when information is being sent through the adapter. This is a good way to tell if your communication link is active.

## RS-232 settings

In order for the computer to communicate with the DC Load, both must be set to the same RS-232 settings. These communication settings are:

1. Baud rate must be one of 4800, 9600, 19200, or 38400.
2. 8 data bits.
3. One stop bit.
4. No parity.

## Overview of DC Load programming

### Packet structure

The DC Load is programmed using packets of bytes. A packet always contains 26 bytes, either going to or coming from the instrument. The basic programming rule is:

You send a **26 byte** packet to the instrument. You then read a **26 byte** packet back from the DC Load to either

- Get the status of your submitted packet, or
- Get the data you requested.

The following are conventions we will follow in this chapter:

1. Hexadecimal integers will be represented by the prefix 0x.
2. Numbers are in base 10 number system unless otherwise indicated.
3. Byte numbering is zero-based, meaning numbering starts with 0.

The structure of each 26 byte packet is:

Byte 0	Byte 1	Byte 2	Byte 3 to 24	Byte 25
0xAA	Address	Command	Command's data	Checksum

Thus, the first byte of any command packet or returned packet is always 0xAA.

Address must be a byte that is between 0x00 and 0xFE. Setting of the address is optional. It is not required to communicate with the instrument. The address can be set from the front panel and is stored in non-volatile memory. This feature is useful when communicating via USB, and connecting several instruments, e.g. via a USB hub. In this scenario, Windows assigns a virtual COM port to each device which is unknown prior to establishing communications with the instrument (could be different each time). In this case, the user can correlate each virtual COM port randomly assigned by Windows with a user defined address.

Command is a byte that identifies which DC Load command is used.

The area for the command's data contains parameter information for the command or the data that is requested via a previous command. Some commands have no data at all. It is a good programming practice to set all unused bytes to 0x00.

The checksum number is the arithmetic sum of each of the bytes modulo 256.

### Status packets

When you send a command that does not cause the DC Load to send requested information back to you, you will receive a status packet back. The structure of a status packet is

Byte 0	Byte 1	Byte 2	Byte 3	Byte 4 to 24	Byte 25
0xAA	Address	0x12	Status byte	Reserved	Checksum

The meaning of the return status byte is defined below:

0x90	Checksum incorrect
0xA0	Parameter incorrect
0xB0	Unrecognized command
0xC0	Invalid command
0x80	Command was successful

### Example program

As you have seen, the native programming interface to the DC loads is fairly low-level. It involves sending 26 byte commands and receiving 26 byte responses from the instrument. To demonstrate how to write your own source code to remotely control the DC load, we provide a custom program written in python which translates well into other text based languages like C/C++

About Python: Python is a dynamic object-oriented programming language that can be used for various kinds of software development. It offers strong support for integration with other languages and tools, comes with extensive standard libraries, and is easy to learn in a few days time. Python is distributed under an OSI-approved open source license that makes it free to use.

You can download a complete python program along with detailed documentation from our website at [www.bkprecision.com](http://www.bkprecision.com). Also available under the download area is a high level library which will make programming much easier as it does the low level bit manipulation for you. Instead of sending a 26 byte string, you can send a high level command such as SetMaxCurrent(current)

#### Example script:

```
# Set DC load to remote mode.

import serial
length_packet = 26 # Number of bytes in a packet

def DumpCommand(bytes):
    assert(len(bytes) == length_packet)
    header = " "*3
    print header,
    for i in xrange(length_packet):
        if i % 10 == 0 and i != 0:
            print
            print header,
        if i % 5 == 0:
```

```

        print " ",
        s = "%02x" % ord(bytes[i])
        if s == "00":
            s = chr(250)*2
        print s,
    print

def CalculateChecksum(cmd):
    assert((len(cmd) == length_packet - 1) or (len(cmd) ==
length_packet))
    checksum = 0
    for i in xrange(length_packet - 1):
        checksum += ord(cmd[i])
    checksum %= 256
    return checksum

def main():
    port = 3 # COM4 for my computer
    baudrate = 38400
    sp = serial.Serial(port, baudrate) # Open a serial connection
    # Construct a set to remote command
    cmd = chr(0xaa) + chr(0x00) + chr(0x20) # First three bytes
    cmd += chr(0x01) + chr(0x00)*(length_packet - 1 - 4)
    cmd += chr(CalculateChecksum(cmd))
    assert(len(cmd) == length_packet)

    # Send command to DC load
    sp.write(cmd)
    print "Set to remote command:"
    DumpCommand(cmd)

    # Get response from DC load
    response = sp.read(length_packet)
    assert(len(response) == length_packet)
    print "Response:"
    DumpCommand(response)

main()

```

The first three lines of the `main()` function set up a serial port to talk to. The next five lines construct the string that we will send to the DC load. The `chr()` function creates a single character that has the ASCII value of the argument. The `+` symbols allow strings to be concatenated. The expression `chr(0)*a_number` creates a string of ASCII `0x00` characters whose length is `a_number`. . The last character is the checksum of the previous 25 characters, calculated for us by the `CalculateChecksum()` function.

When a command is sent to the instrument, you must always request for return data, which will always be another 26 bytes. This is also dumped to the screen.

Here are the printed results when the above script is ran:

```
Set to remote command:
aa ·· 20 01 ··  ·· ·· ·· ·· ··
·· ·· ·· ·· ··  ·· ·· ·· ·· ··
·· ·· ·· ·· ··  cb

Response:
aa ·· 12 80 ··  ·· ·· ·· ·· ··
·· ·· ·· ·· ··  ·· ·· ·· ·· ··
·· ·· ·· ·· ··  3c
```

The · characters represent the bytes with a value of 0x00. This makes it easier to see the nonzero bytes in the string.

The first byte of a command is always 0xaa and the second byte is the address of the DC load. The address should be set to 0. The third byte identifies the command "set to remote" and the fourth byte is a 1, which means enable remote mode. If the fourth byte was 0, this command would set the DC load to local mode.

The third byte of the response string is 0x12, which means this is a packet that gives the status of the last command sent. The fourth byte is 0x80, which means the command completed successfully.

On the DC load, you should see the Rmt annunciator turned on immediately after running the script. You will also see the Link annunciator light up while communications are going on, then blink out after a few seconds.

Press Shift + Local to set the DC load back to local mode.

We've learned two key things about the DC load:

1. Commands are always sent as 26 byte packets.
2. For any command you send to the DC load, you must also request the return of a 26 byte packet. This returned packet will either be a status packet or an information packet containing data you requested -- for example, the power level currently set.

Get in the habit of looking at the LEDs on the IT-E131 or IT-E132 interfaces. Every command you send to the DC load should result in both the RX and TX LEDs blinking once. If this does not happen, something is wrong with the code, interface, or instrument.

## Chapter organization

The remainder of this chapter contains a reference on the syntax of DC Load commands and some

example programs. The **Summary of commands** section is a list of the commands, but without details. The **Command details** section explains how to use each command.

## Summary of commands

The Byte values in the following table are used to identify the commands to be sent in the command packet (byte 2).

Command Group	Byte	Action
Return data	0x12	Indicates a packet that returns the status of the last command you sent to the DC Load
Remote	0x20	Set the DC Load to remote operation
ON/OFF	0x21	Turn the load ON or OFF
Maximum parameter values	0x22	Set the maximum voltage allowed
	0x23	Read the maximum voltage allowed
	0x24	Set the maximum current allowed
	0x25	Read the maximum current allowed
	0x26	Set the maximum power allowed
	0x27	Read the maximum power allowed
Operation mode	0x28	Set CC, CV, CW, or CR mode
	0x29	Read the mode being used (CC, CV, CW, or CR)
Mode parameters	0x2A	Set CC mode current
	0x2B	Read CC mode current
	0x2C	Set CV mode voltage
	0x2D	Read CV mode voltage
	0x2E	Set CW mode power
	0x2F	Read CW mode power
	0x30	Set CR mode resistance
	0x31	Read CR mode resistance
Transient parameters	0x32	Set CC mode transient current and timing
	0x33	Read CC mode transient parameters
	0x34	Set CV mode transient voltage and timing
	0x35	Read CV mode transient parameters
	0x36	Set CW mode transient power and timing
	0x37	Read CW mode transient parameters
	0x38	Set CR mode transient resistance and timing
	0x39	Read CR mode transient parameters
List operations	0x3A	Select the list operation (CC/CV/CW/CR)
	0x3B	Read the list operation (CC/CV/CW/CR)

<b>Command Group</b>	<b>Byte</b>	<b>Action</b>
	0x3C	Set how lists repeat (ONCE or REPEAT)
	0x3D	Read how lists repeat
	0x3E	Set the number of list steps
	0x3F	Read the number of list steps
	0x40	Set one of the step's current and time values
	0x41	Read one of the step's current and time values
	0x42	Set one of the step's voltage and time values
	0x43	Read one of the step's voltage and time values
	0x44	Set one of the step's power and time values
	0x45	Read one of the step's power and time values
	0x46	Set one of the step's resistance and time values
	0x47	Read one of the step's resistance and time values
	0x48	Set the list file name
	0x49	Read the list file name
	0x4A	Set the memory partitioning for storing lists
	0x4B	Read the memory partitioning for storing list steps
	0x4C	Store the list file
0x4D	Recall the list file	
Battery testing	0x4E	Set minimum voltage in battery testing
	0x4F	Read minimum voltage in battery testing
LOAD ON	0x50	Set timer value of for LOAD ON
	0x51	Read timer value for LOAD ON
	0x52	Disable/enable timer for LOAD ON
	0x53	Read timer state for LOAD ON
Address	0x54	Set communication address
LOCAL	0x55	Enable/disable LOCAL control
Remote sensing	0x56	Enable/disable remote sensing
	0x57	Read the state of remote sensing
Triggering	0x58	Select trigger source
	0x59	Read trigger source
	0x5A	Trigger the electronic load
Store/Recall	0x5B	Store DC Load's settings
	0x5C	Recall DC Load's settings
Function	0x5D	Select FIXED/SHORT/TRAN/LIST/BATTERY function

Command Group	Byte	Action
	0x5E	Get function type (FIXED/SHORT/TRAN/LIST/BATTERY)
Read display values	0x5F	Read input voltage, current, power and relative state
Calibration	0x60	Enter instrument calibration state
	0x61	Get the instrument calibration state
	0x62	Set voltage calibration point index
	0x63	Send the actual voltage to the calibration program
	0x64	Set current calibration point index
	0x65	Send the actual current to the calibration program
	0x66	Store the calibration data to EEPROM
	0x67	Set calibration information
	0x68	Read calibration information
	0x69	Restore the factory default calibration data
Product information	0x6A	Get product's model, serial number, and firmware version
	0x6B	Read the bar code information

## Command details

In the following, please remember that the word **mode** only refers to one of the four operational modes of the DC Load: constant current (CC), constant voltage (CV), constant power (CW), or constant resistance (CR).

### Notation for tables

In the following sections, we abbreviate the details of the commands. Since the first three bytes of a command are i) the constant 0xAA, ii) the instrument address, and iii) the command, we will not show those for each command. In addition, the 26th byte, the checksum, will also not be shown.

The table includes a column for **Byte offset**. This is the zero-based index of the byte in the packet. Note the offset numbers are in decimal.

A table entry of "Reserved" means the data are currently unused or reserved for future use. Good programming practice is to set these bytes to 0x00.

Some commands require two byte and four byte integers to represent parameter settings. These integers are stored in the command packet in **little-endian** format. Little-endian is a byte ordering format in which bytes with lower addresses have lower significance. We will refer to the individual bytes as follows:

For a two byte integer, the least significant byte will be called the low byte and the most significant byte will be called the high byte.

For a four byte integer, we will use the following notation:

Least significant two bytes, least significant byte	Lower low byte
Least significant two bytes, most significant byte	Lower high byte
Most significant two bytes, least significant byte	Higher low byte
Most significant two bytes, most significant byte	Higher high byte

As an example, for the integer 0x23A749F5, we'd have

1st byte	<b>0xF5</b> Lower low byte
2nd byte	<b>0x49</b> Lower high byte
3rd byte	<b>0xA7</b> Higher low byte
4th byte	<b>0x23</b> Higher high byte

**0x12 Indicates a return packet for a command sent to the DC Load**

Byte offset	Meaning
3	Status byte (i.e., status of last command sent to DC Load).
4-24	Reserved

Below is a table of all possible status byte values and their corresponding indication.

0x90	Checksum incorrect
0xA0	Parameter incorrect
0xB0	Unrecognized command
0xC0	Invalid command
0x80	Command was successful

**0x20 Set the DC Load to remote operation**

Byte offset	Meaning
3	0 means front panel operation. 1 means remote operation.
4-24	Reserved

**0x21 Turn the load ON or OFF**

Byte offset	Meaning
3	0 is OFF. 1 is ON.
4-24	Reserved

**0x22 Set the maximum voltage allowed**

Byte offset	Meaning
3	Lower low byte of maximum voltage. 1 represents 1 mV.
4	Lower high byte of maximum voltage.
5	Upper low byte of maximum voltage.
6	Upper high byte of maximum voltage.

Byte offset	Meaning
7-24	Reserved

**Example:** Suppose you want to set the maximum voltage to 16.23V. Since 1 represents 1mV, therefore 16.23V translates to 16,230 in decimal. With 4 bytes in Hex, that would be 0x0003F6A. Since the bytes are ordered in little-endian format, 0x6A would be the 3<sup>rd</sup> byte, 0x3F the 4<sup>th</sup> byte, 0x00 as 5<sup>th</sup> byte, and 0x00 as the 6<sup>th</sup> byte.

**0x23 Read the maximum voltage allowed**

Byte offset	Meaning
3	Lower low byte of maximum voltage. 1 represents 1 mV.
4	Lower high byte of maximum voltage.
5	Upper low byte of maximum voltage.
6	Upper high byte of maximum voltage.
7-24	Reserved

**0x24 Set the maximum current allowed**

Byte offset	Meaning
3	Lower low byte of maximum current. 1 represents 0.1 mA.
4	Lower high byte of maximum current.
5	Upper low byte of maximum current.
6	Upper high byte of maximum current.
7-24	Reserved

**Example:** Suppose you want to set the maximum current to 3.12A. Since 1 represents 0.1mA, 3.12A translates to 31,200 in decimal. With 4 bytes in Hex, that would be 0x000079E0. Since the bytes are ordered in little-endian format, 0xE0 would be the 3<sup>rd</sup> byte, 0x79 the 4<sup>th</sup> byte, 0x00 as 5<sup>th</sup> byte, and 0x00 as the 6<sup>th</sup> byte.

**0x25 Read the maximum current allowed**

Byte offset	Meaning
3	Lower low byte of maximum current. 1 represents 0.1 mA.
4	Lower high byte of maximum current.
5	Upper low byte of maximum current.
6	Upper high byte of maximum current.

Byte offset	Meaning
7-24	Reserved

**0x26 Set the maximum power allowed**

Byte offset	Meaning
3	Lower low byte of maximum power. 1 represents 1 mW.
4	Lower high byte of maximum power.
5	Upper low byte of maximum power.
6	Upper high byte of maximum power.
7-24	Reserved

**Example:** Suppose you want to set the maximum power to 213.45W. Since 1 represents 1mW, 213.45W translates to 213,450 in decimal. With 4 bytes in Hex, that would be 0x000341CA. Since the bytes are ordered in little-endian format, 0xCA would be the 3<sup>rd</sup> byte, 0x41 the 4<sup>th</sup> byte, 0x03 as 5<sup>th</sup> byte, and 0x00 as the 6<sup>th</sup> byte.

**0x27 Read the maximum power allowed**

Byte offset	Meaning
3	Lower low byte of maximum power. 1 represents 1 mW.
4	Lower high byte of maximum power.
5	Upper low byte of maximum power.
6	Upper high byte of maximum power.
7-24	Reserved

**0x28 Set CC, CV, CW, or CR mode**

Byte offset	Meaning
3	Mode: 0 is CC 1 is CV 2 is CW 3 is CR
4-24	Reserved

**0x29 Read the mode being used (CC, CV, CW, or CR)**

Byte offset	Meaning
3	Mode:

Byte offset	Meaning
	0 is CC 1 is CV 2 is CW 3 is CR
4-24	Reserved

**0x2A Set CC mode current**

Byte offset	Meaning
3	Lower low byte of current. 1 represents 0.1 mA.
4	Lower high byte of current.
5	Upper low byte of current.
6	Upper high byte of current.
7-24	Reserved

**0x2B Read CC mode current**

Byte offset	Meaning
3	Lower low byte of current. 1 represents 0.1 mA.
4	Lower high byte of current.
5	Upper low byte of current.
6	Upper high byte of current.
7-24	Reserved

**0x2C Set CV mode voltage**

Byte offset	Meaning
3	Lower low byte of voltage. 1 represents 1 mV.
4	Lower high byte of voltage.
5	Upper low byte of voltage.
6	Upper high byte of voltage.
7-24	Reserved

**0x2D Read CV mode voltage**

Byte offset	Meaning
3	Lower low byte of voltage. 1 represents 1 mV.
4	Lower high byte of voltage.

Byte offset	Meaning
5	Upper low byte of voltage.
6	Upper high byte of voltage.
7-24	Reserved

**0x2E Set CW mode power**

Byte offset	Meaning
3	Lower low byte of power. 1 represents 1 mW.
4	Lower high byte of power.
5	Upper low byte of power.
6	Upper high byte of power.
7-24	Reserved

**0x2F Read CW mode power**

Byte offset	Meaning
3	Lower low byte of power. 1 represents 1 mW.
4	Lower high byte of power.
5	Upper low byte of power.
6	Upper high byte of power.
7-24	Reserved

**0x30 Set CR mode resistance**

Byte offset	Meaning
3	Lower low byte of resistance. 1 represents 1 $\Omega$ .
4	Lower high byte of resistance.
5	Upper low byte of resistance.
6	Upper high byte of resistance.
7-24	Reserved

**0x31 Read CR mode resistance**

Byte offset	Meaning
3	Lower low byte of resistance. 1 represents 1 $\Omega$ .
4	Lower high byte of resistance.
5	Upper low byte of resistance.

Byte offset	Meaning
6	Upper high byte of resistance.
7-24	Reserved

**0x32 Set CC mode transient current and timing**

Byte offset	Meaning
3 to 6	Value A of current in units of 0.1 mA. Little-endian 4 byte number.
7 to 8	Time for A current in units of 0.1 ms. Little-endian 2 byte number.
9 to 12	Value B of current in units of 0.1 mA. Little-endian 4 byte number.
13 to 14	Time for B current in units of 0.1 ms. Little-endian 2 byte number.
15	Transient operation: 0 is CONTINUOUS 1 is PULSE 2 is TOGGLED
16-24	Reserved

**0x33 Read CC mode transient parameters**

Byte offset	Meaning
3 to 6	Value A of current in units of 0.1 mA. Little-endian 4 byte number.
7 to 8	Time for A current in units of 0.1 ms. Little-endian 2 byte number.
9 to 12	Value B of current in units of 0.1 mA. Little-endian 4 byte number.
13 to 14	Time for B current in units of 0.1 ms. Little-endian 2 byte number.
15	Transient operation: 0 is CONTINUOUS 1 is PULSE 2 is TOGGLED
16-24	Reserved

**0x34 Set CV mode transient voltage and timing**

Byte offset	Meaning
3 to 6	Value A of voltage in units of 1 mV. Little-endian 4 byte number.
7 to 8	Time for A voltage in units of 0.1 ms. Little-endian 2 byte number.
9 to 12	Value B of voltage in units of 1 mV. Little-endian 4 byte number.
13 to 14	Time for B voltage in units of 0.1 ms. Little-endian 2 byte number.
15	Transient operation: 0 is CONTINUOUS

Byte offset	Meaning
	1 is PULSE 2 is TOGGLED
16-24	Reserved

### **0x35 Read CV mode transient parameters**

Byte offset	Meaning
3 to 6	Value A of voltage in units of 1 mV. Little-endian 4 byte number.
7 to 8	Time for A voltage in units of 0.1 ms. Little-endian 2 byte number.
9 to 12	Value B of voltage in units of 1 mV. Little-endian 4 byte number.
13 to 14	Time for B voltage in units of 0.1 ms. Little-endian 2 byte number.
15	Transient operation: 0 is CONTINUOUS 1 is PULSE 2 is TOGGLED
16-24	Reserved

### **0x36 Set CW mode transient power and timing**

Byte offset	Meaning
3 to 6	Value A of power in units of 1 mW. Little-endian 4 byte number.
7 to 8	Time for A power in units of 0.1 ms. Little-endian 2 byte number.
9 to 12	Value B of power in units of 1 mW. Little-endian 4 byte number.
13 to 14	Time for B power in units of 0.1 ms. Little-endian 2 byte number.
15	Transient operation: 0 is CONTINUOUS 1 is PULSE 2 is TOGGLED
16-24	Reserved

### **0x37 Read CW mode transient parameters**

Byte offset	Meaning
3 to 6	Value A of power in units of 1 mW. Little-endian 4 byte number.
7 to 8	Time for A power in units of 0.1 ms. Little-endian 2 byte number.
9 to 12	Value B of power in units of 1 mW. Little-endian 4 byte number.
13 to 14	Time for B power in units of 0.1 ms. Little-endian 2 byte number.
15	Transient operation:

Byte offset	Meaning
	0 is CONTINUOUS 1 is PULSE 2 is TOGGLED
16-24	Reserved

**0x38 Set CR mode transient resistance and timing**

Byte offset	Meaning
3 to 6	Value A of resistance in units of 1 $\Omega$ . Little-endian 4 byte number.
7 to 8	Time for A resistance in units of 0.1 ms. Little-endian 2 byte number.
9 to 12	Value B of resistance in units of 1 $\Omega$ . Little-endian 4 byte number.
13 to 14	Time for B resistance in units of 0.1 ms. Little-endian 2 byte number.
15	Transient operation: 0 is CONTINUOUS 1 is PULSE 2 is TOGGLED
16-24	Reserved

**0x39 Read CR mode transient parameters**

Byte offset	Meaning
3 to 6	Value A of resistance in units of 1 $\Omega$ . Little-endian 4 byte number.
7 to 8	Time for A resistance in units of 0.1 ms. Little-endian 2 byte number.
9 to 12	Value B of resistance in units of 1 $\Omega$ . Little-endian 4 byte number.
13 to 14	Time for B resistance in units of 0.1 ms. Little-endian 2 byte number.
15	Transient operation: 0 is CONTINUOUS 1 is PULSE 2 is TOGGLED
16-24	Reserved

**0x3A Select the list operation (CC/CV/CW/CR)**

Byte offset	Meaning
3	List operation mode: 0 is constant current (CC) 1 is constant voltage (CV) 2 is constant power (CW) 3 is constant resistance (CR)

Byte offset	Meaning
4-24	Reserved

**0x3B Read the list operation (CC/CV/CW/CR)**

Byte offset	Meaning
3	List operation mode: 0 is constant current (CC) 1 is constant voltage (CV) 2 is constant power (CW) 3 is constant resistance (CR)
4-24	Reserved

**0x3C Set how lists repeat (ONCE or REPEAT)**

Byte offset	Meaning
3	How lists repeat: 0 is ONCE 1 is REPEAT
4-24	Reserved

**0x3D Read how lists repeat (ONCE or REPEAT)**

Byte offset	Meaning
3	How lists repeat: 0 is ONCE 1 is REPEAT
4-24	Reserved

**0x3E Set the number of list steps**

Byte offset	Meaning
3 to 4	2 byte little-endian integer for number of steps
5-24	Reserved

**0x3F Read the number of list steps**

Byte offset	Meaning
3 to 4	2 byte little-endian integer for number of steps
5-24	Reserved

**0x40 Set one of the step's current and time values**

Byte offset	Meaning
3 to 4	2 byte little-endian integer specifying which step number in the list
5 to 8	4 byte little-endian integer specifying the current in units of 0.1 mA
9 to 10	2 byte little-endian integer specifying the step timing in units of 0.1 ms
11-24	Reserved

**0x41 Read one of the step's current and time values**

Byte offset	Meaning
3 to 4	2 byte little-endian integer specifying which step number in the list
5 to 8	4 byte little-endian integer specifying the current in units of 0.1 mA
9 to 10	2 byte little-endian integer specifying the step timing in units of 0.1 ms
11-24	Reserved

**0x42 Set one of the step's voltage and time values**

Byte offset	Meaning
3 to 4	2 byte little-endian integer specifying which step number in the list
5 to 8	4 byte little-endian integer specifying the voltage in units of 1 mV
9 to 10	2 byte little-endian integer specifying the step timing in units of 0.1 ms
11-24	Reserved

**0x43 Read one of the step's voltage and time values**

Byte offset	Meaning
3 to 4	2 byte little-endian integer specifying which step number in the list
5 to 8	4 byte little-endian integer specifying the voltage in units of 1 mV
9 to 10	2 byte little-endian integer specifying the step timing in units of 0.1 ms
11-24	Reserved

**0x44 Set one of the step's power and time values**

Byte offset	Meaning
3 to 4	2 byte little-endian integer specifying which step number in the list
5 to 8	4 byte little-endian integer specifying the power in units of 1 mW
9 to 10	2 byte little-endian integer specifying the step timing in units of 0.1 ms
11-24	Reserved

**0x45 Read one of the step's power and time values**

Byte offset	Meaning
3 to 4	2 byte little-endian integer specifying which step number in the list
5 to 8	4 byte little-endian integer specifying the power in units of 1 mW
9 to 10	2 byte little-endian integer specifying the step timing in units of 0.1 ms
11-24	Reserved

**0x46 Set one of the step's resistance and time values**

Byte offset	Meaning
3 to 4	2 byte little-endian integer specifying which step number in the list
5 to 8	4 byte little-endian integer specifying the resistance in units of 0.1 $\Omega$
9 to 10	2 byte little-endian integer specifying the step timing in units of 0.1 ms
11-24	Reserved

**0x47 Read one of the step's resistance and time values**

Byte offset	Meaning
3 to 4	2 byte little-endian integer specifying which step number in the list
5 to 8	4 byte little-endian integer specifying the resistance in units of 0.1 $\Omega$
9 to 10	2 byte little-endian integer specifying the step timing in units of 0.1 ms
11-24	Reserved

**0x48 Set the list file name**

Byte offset	Meaning
3 to 12	List file name (ASCII characters)
13-24	Reserved

**0x49 Read the list file name**

Byte offset	Meaning
3 to 12	List file name (ASCII characters)
13-24	Reserved

**0x4A Set the memory partitioning for storing lists**

Byte offset	Meaning
3	Partition scheme: 1 means 1 file of 1000 list steps

Byte offset	Meaning
	2 means 2 files of 500 list steps 4 means 4 files of 250 list steps 8 means 8 files of 120 list steps
4-24	Reserved

**0x4B Read the memory partitioning for storing list steps**

Byte offset	Meaning
3	Partition scheme: 1 means 1 file of 1000 list steps 2 means 2 files of 500 list steps 4 means 4 files of 250 list steps 8 means 8 files of 120 list steps
4-24	Reserved

**0x4C Save the list file**

Byte offset	Meaning
3	Storage location, a one byte integer from 1 to 8. This number must be consistent with the number of list files allowed as set by the 0x4A command.
4-24	Reserved

**0x4D Recall the list file**

Byte offset	Meaning
3	Storage location, a one byte integer from 1 to 8.
4-24	Reserved

**0x4E Set minimum voltage in battery testing**

Byte offset	Meaning
3 to 6	4 byte little-endian integer specifying the minimum voltage in units of 1 mV
7-24	Reserved

**0x4F Read minimum voltage in battery testing**

Byte offset	Meaning
3 to 6	4 byte little-endian integer specifying the minimum voltage in units of 1 mV
7-24	Reserved

**0x50 Set timer value of for LOAD ON**

Byte offset	Meaning
3 to 4	2 byte little-endian integer specifying the time in units of 1 second
5-24	Reserved

**0x51 Read timer value for LOAD ON**

Byte offset	Meaning
3 to 4	2 byte little-endian integer specifying the time in units of 1 second
5-24	Reserved

**0x52 Disable/enable timer for LOAD ON**

Byte offset	Meaning
3	0 is disable timer 1 is enable timer
4-24	Reserved

**0x53 Read timer state for LOAD ON**

Byte offset	Meaning
3	0 is disable timer 1 is enable timer
4-24	Reserved

**0x54 Set communication address**

Byte offset	Meaning
3	2 byte little-endian integer specifying the address. Must be between 0 and 0xFE, inclusive.
4-24	Reserved

**0x55 Enable/disable LOCAL control**

Byte offset	Meaning
3	0 means to disable the Local key on the front panel 1 means to enable the Local key on the front panel
4-24	Reserved

**0x56 Enable/disable remote sensing**

Byte offset	Meaning
3	0 means to disable remote sensing 1 means to enable remote sensing
4-24	Reserved

**0x57 Read the state of remote sensing**

Byte offset	Meaning
3	0 means remote sensing is disabled 1 means remote sensing is enabled
4-24	Reserved

**0x58 Select trigger source**

Byte offset	Meaning
3	Trigger: 0 means immediate trigger (i.e., triggered from the front panel) 1 means external trigger from the rear panel connector 2 means a bus (software) trigger (the 0x5A command)
4-24	Reserved

**0x59 Read trigger source**

Byte offset	Meaning
3	Trigger: 0 means immediate trigger (i.e., triggered from the front panel) 1 means external trigger from the rear panel connector 2 means a bus (software) trigger (the 0x5A command)
4-24	Reserved

**0x5A Trigger the electronic load**

Byte offset	Meaning
3-24	Reserved

**0x5B Save DC Load's settings**

Byte offset	Meaning
3	Storage register, a number between 1 and 25 inclusive
4-24	Reserved

**0x5C Recall DC Load's settings**

Byte offset	Meaning
3	Storage register, a number between 1 and 25 inclusive
4-24	Reserved

**0x5D Select *FIXED/SHORT/TRAN/LIST/BATTERY* function**

Byte offset	Meaning
3	Function: 0 means FIXED 1 means SHORT 2 means TRANSIENT 3 means LIST 4 means BATTERY
4-24	Reserved

**0x5E Get function type (*FIXED/SHORT/TRAN/LIST/BATTERY*)**

Byte offset	Meaning
3	Function: 0 means FIXED 1 means SHORT 2 means TRANSIENT 3 means LIST 4 means BATTERY
4-24	Reserved

**0x5F Read input voltage, current, power and relative state**

Byte offset	Meaning
3 to 6	4 byte little-endian integer for terminal voltage in units of 1 mV
7 to 10	4 byte little-endian integer for terminal current in units of 0.1 mA
11 to 14	4 byte little-endian integer for terminal power in units of 1 mW
15	Operation state register (see bit list below)
16 to 17	2 byte little-endian integer for demand state register (see bit list below)
18-24	Reserved

The operation state register's bit meanings are:

Bit	Meaning
0	Calculate the new demarcation coefficient
1	Waiting for a trigger signal

Bit	Meaning
2	Remote control state (1 means enabled)
3	Output state (1 means ON)
4	Local key state (0 means not enabled, 1 means enabled)
5	Remote sensing mode (1 means enabled)
6	LOAD ON timer is enabled
7	Reserved

The demand state register's bit meanings are:

Bit	Meaning
0	Reversed voltage is at instrument's terminals (1 means yes)
1	Over voltage (1 means yes)
2	Over current (1 means yes)
3	Over power (1 means yes)
4	Over temperature (1 means yes)
5	Not connect remote terminal
6	Constant current
7	Constant voltage
8	Constant power
9	Constant resistance

### ***0x60 Enter instrument calibration state***

Byte offset	Meaning
3	Calibration state: 0 means disable 1 means enable
4	0x85 (low byte of calibration password)
5	0x11 or 0x12 (high byte of calibration password)
6-24	Reserved

### ***0x61 Get the instrument calibration state***

Byte offset	Meaning
3	Calibration protection state: Bit 0: value of 0 means the calibration state is not protected Bit 0: value of 1 means the calibration state is protected

Byte offset	Meaning
4-24	Reserved

**0x62 Set voltage calibration point index**

Byte offset	Meaning
3	Voltage calibration point. Valid values are 0x01 to 0x04.
4-24	Reserved

The DC Load has four calibration points for voltage. These would typically span the full range of the instrument's voltage range.

**0x63 Send the actual voltage to the calibration program**

Byte offset	Meaning
3 to 6	4 byte little-endian integer representing the voltage in units of mV
7-24	Reserved

**0x64 Set current calibration point index**

Byte offset	Meaning
3	Current calibration point. Valid values are 0x01 to 0x04.
4-24	Reserved

The DC Load has four calibration points for current. These would typically span the full range of the instrument's current range.

**0x65 Send the actual current to the calibration program**

Byte offset	Meaning
3 to 6	4 byte little-endian integer representing the current in units of 0.1 mA
7-24	Reserved

**0x66 Store the calibration data to EEPROM**

Byte offset	Meaning
3-24	Reserved

The stored calibration data will be used the next time the DC Load is power cycled.

**0x67 Set calibration information**

Byte offset	Meaning
3 to 22	ASCII information representing the calibration. Example: you might wish to store the date and time of the calibration and the initials of the person who performed the calibration.
23-24	Reserved

**0x68 Read calibration information**

Byte offset	Meaning
3 to 22	ASCII information representing the calibration.
23-24	Reserved

**0x69 Restore the factory default calibration data**

Byte offset	Meaning
3-24	Reserved

**0x6A Get product's model, serial number, and firmware version**

Byte offset	Meaning
3 to 7	ASCII model information
8	Low byte of firmware version number
9	High byte of firmware version number
10 to 19	Instrument's serial number in ASCII
20-24	Reserved

**0x6B Read the bar code information**

Note: the bar code information is to be interpreted as ASCII data.

Byte offset	Meaning
3 to 5	Identity
6 to 7	Sub
7 to 9	Version
10 to 11	Year
12-24	Reserved

## Serial number and firmware version

To find out the serial number and firmware version of the DC load, turn the instrument on. While the **SYSTEM SELFTEST** message is displayed, quickly press and hold down the **Shift** key. By pressing the **▲** and **▼** keys, you will see the following information:

<b>120V 30A 320W</b>	Instrument's capabilities
<b>SN: XXX-XXX-XXX</b>	Serial number
<b>VER: X.XX</b>	Firmware version

Press the **Esc** key to return to normal operation of the instrument.

## In case of trouble

### Instrument won't turn on

If the instrument won't turn on when the **POWER** switch is pressed in, please ensure the power cord is plugged into the back of the instrument and the other end of the cord is plugged into a live AC power outlet.

If the instrument still won't turn on, remove the power cord from the instrument. Open the fuse container on the rear panel and check the fuse for continuity.

If the fuse is an open circuit, replace it with the proper fuse indicated in the following table:

Model	Fuse specification for 110 VAC operation	Fuse specification for 220 VAC operation
8500	T0.5A, 250 VAC	T0.3A, 250 VAC
8502	T0.5A, 250 VAC	T0.3A, 250 VAC
8510	T0.5A, 250 VAC	T0.3A, 250 VAC
8512	T2.5A, 250 VAC	T0.1.25A, 250 VAC
8514	T2.5A, 250 VAC	T0.1.25A, 250 VAC
8518	T2.5A, 250 VAC	T0.1.25A, 250 VAC
8520	T2.5A, 250 VAC	T0.1.25A, 250 VAC
8522	T2.5A, 250 VAC	T0.1.25A, 250 VAC
8524	T5A, 250 VAC	T2.5A, 250 VAC
8526	T5A, 250 VAC	T2.5A, 250 VAC

#### **WARNING**

Ensure that the fuse is rated for 250 VAC operation. Lower voltage rated fuses are not suitable for this instrument.

### Error messages during power-up

EEPROM ERROR means the calibration data have been lost or the EEPROM is not functional.

ERROR CAL.DATA means that the calibration data have been lost.

If you experience these error messages, the instrument should be returned to B&K Precision for service.

### Keypad unlock procedure (Keypad was accidentally locked)

If you accidentally locked the keyboard, follow this procedure to unlock: The procedure below shows how to unlock a model 8500 using "8512" as the unlock key.

- 1) Press **Shift + Menu**. You will see **PASSWORD:** displayed on the screen. Enter 8512, then press the **Enter** key. Now you will see **Connect** on the display
- 2) Press **Enter**, locate menu Key Lock set, press **Enter**. Enter **8512**, confirm with **Enter**, press

**Enter** again. Now the password is cleared. Press **Esc** to exit the menu

To unlock the other DC load models, use the following unlock keys:

Model number	Unlock key code
8500	8512
8502	8512
8510	8513
8512	8513
8514	8514
8518	8518
8520	8516
8522	8516
8524	8518
8526	8518



# Index

Battery.....	21	Mode settings.....	29
Battery test.....	7, 21, 32	P-set.....	21
CC.....	21	Present a constant resistance.....	6
Condition.....	21	R-set.....	22
Constant current.....	9, 11, 21, 29	Recall.....	10, 12, 22, 43
Constant power.....	9, 11, 21, 30	Remote sensing.....	11p., 22, 42
Constant resistance.....	9, 11, 21p., 31	Resistance.....	31
Constant voltage.....	9, 11, 21p., 30	Resistance .....	31
CR.....	21	S-Tran.....	22
CV.....	21	Shift.....	11, 22
CW.....	21	Shift + $\Delta$ .....	32
Draw a constant current.....	6	Shift + $\nabla$ .....	32
Draw a constant power.....	6	Short.....	10, 12, 22, 32
Draw a constant voltage.....	6	Standard display.....	34pp.
Dynamic condition.....	21	Store.....	10, 22
Enter.....	10, 13	Tran.....	22
Esc.....	10, 12	Transient condition.....	22
I-set.....	21	Transient mode.....	21
List.....	11, 13p., 21, 36	Trigger.....	11pp., 22, 39
Local.....	11, 21	V-set.....	22
Menu.....	8, 12, 21	$\Delta$ .....	32
Menu system.....	10	$\nabla$ .....	21
Mode.....	21		

