

D10CEA SDI to Component/ Composite Video with 4 Channel Audio Converter

User Manual

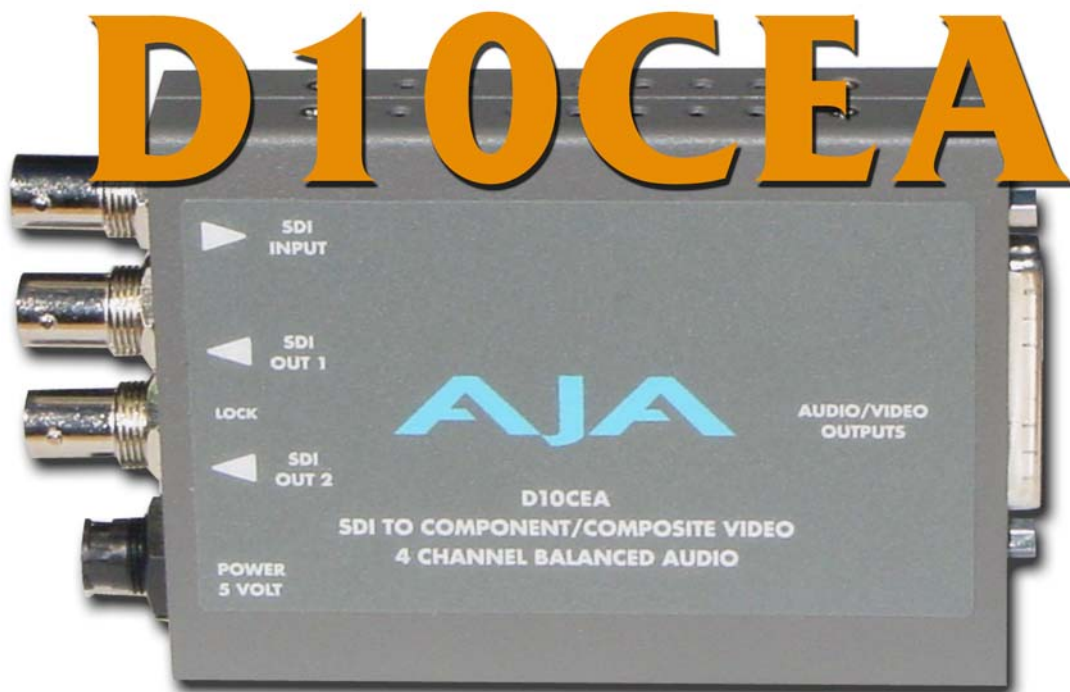

AJA
AJA VIDEO SYSTEMS INC

June 28, 2005 P/N 101637-00

Introduction

The D10CEA converts SDI video with embedded audio to 10-bit component or composite analog video and 4 channel balanced analog audio. The video outputs can be configured as YPbPr (Betacam or SMPTE/EBU N10), RGB, composite or Y/C (S-Video). Two re-clocked loop-thru SDI outputs are also provided. This versatile low-cost converter is ideal for video/audio monitoring.

The 4 channel analog audio outputs can be wired in a balanced or unbalanced configuration. All audio output channels can be selected as group 1-4 from SMPTE embedded audio. You have four settings of Audio level to choose from.

Output connections for video and audio are available on a 25 pin “D” subminiature connector. A break-out cable is supplied with the converter for this purpose.

You can configure video and audio from a DIP switch accessed through a cut-out in the converter’s case.

Features

- SDI to analog audio and video converter
- SDI with embedded audio input
- 2 re-clocked, loop-thru SDI outputs
- 10-bit component or composite analog video outputs
- 4 channel balanced analog audio output
- Selectable audio level
- Selectable audio channel group
- External DIP switch user interface for configuration

Block Diagram

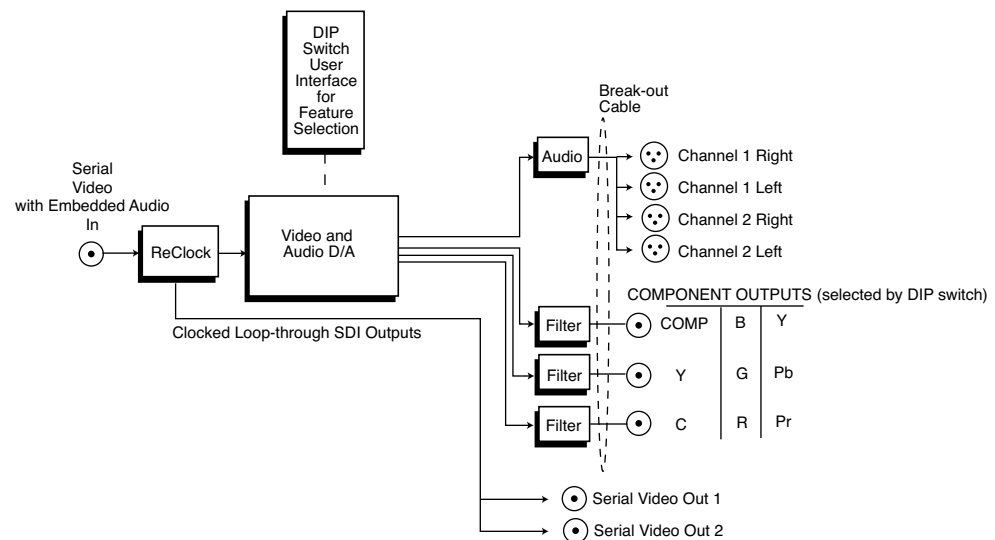

D10CEA SDI Video with Embedded Audio Converter, Block Diagram

I/O Connections

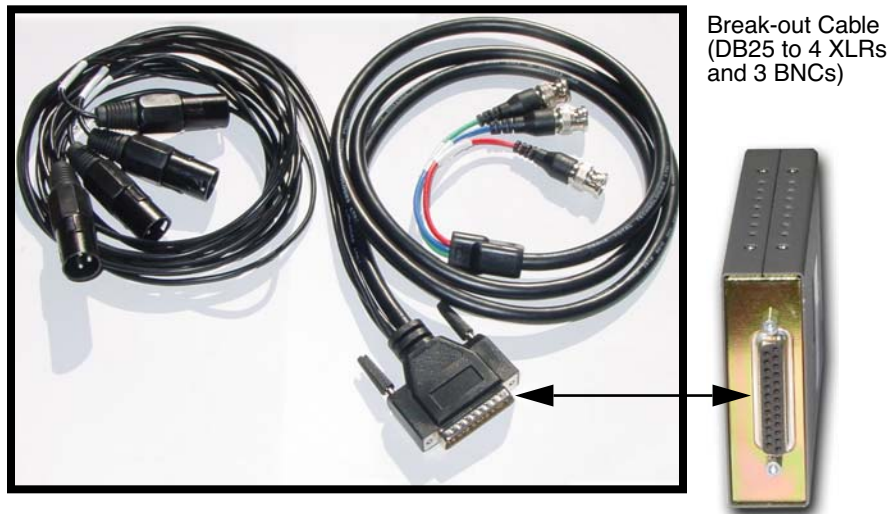

D10CEA and Break-Out Cable

User Controls

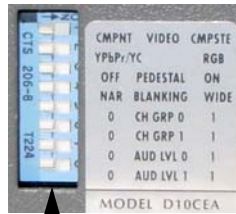

DIP Switches
LEFT ↔ RIGHT

The user interface for the D10CEA is an 8-switch DIP accessible through a cut-out in the bottom of the unit. Use the DIP switches to configure video outputs, pedestal, blanking, select audio channel groups, and set audio level.

Switches 1 through 4 configure video output format. Switches 4 through 8 select the audio channel group and audio level. The exact function of each DIP switch and what it controls is described on the following pages.

Switch 1—Select Component (COMPNT) or Composite (CMPSTE) Out

RIGHT	LEFT
CMPSTE: Selects composite video output	COMPNT: Selects component video output

Switch 2—Selects YPbPr/YC or RGB Component Outputs

RIGHT	LEFT
RGB: Selects RGB	YPbPr/YC: Selects YPbPr/YC component video out

Switch 3—Configure Pedestal For Composite

RIGHT	LEFT
7.5 IRE pedestal for NTSC (also selects BETA 525 levels for YPbPr)	No pedestal (also selects SMPTE levels for YPbPr)

Note: There is no effect with 625 input.

Switch 4—Configure Blanking

RIGHT	LEFT
WIDE Blanking: Vertical— Line numbers indicate where video starts) line 20, field 1; line 20, field 2 (525 line) line 23, field 1; line 336, field 2 (625 line) Horizontal— Active video line duration ITU-R/SMPTE (710 pixels NTSC, 702 pixels PAL)	NARROW (NAR) Blanking: Vertical— Line numbers indicate where video starts line 13, field 1; line 12, field 2 (525 line) line 10, field 1; line 322, field 2 (625 line) Horizontal— Active video line duration's) ITU-R.470 (720 pixels PAUNTSC)~

Switches 5 and 6—Select an Audio Channel Group for Output

Together these two switches select the group of audio channels that will be routed to the XLR connectors on the break-out cable. Each audio group has four channels, corresponding to the four connectors. The following table shows the group and channel assignments selected by each switch position for the two DIP switches.

Group and Channels	S5	S6
Group 0: Channels 1 to 4	Off (Left)	Off (Left)
Group 1: Channels 5 to 8	On (Right)	Off (Left)
Group 2: Channels 9 to 12	Off (Left)	On (Right)
Group 3: Channels 13 to 16	On (Right)	On (Right)

Switches 7 and 8—Select Audio Levels for Output

Together these two switches select audio output levels at the XLR outputs. The following table shows the level selected by each switch position for the two DIP switches.

Audio Level (dbu)	S7	S8
+4.00 dbu	Off (Left)	Off (Left)
+2.00 dbu	On (Right)	Off (Left)
0.00 dbu	Off (Left)	On (Right)
-14.00 dbu	On (Right)	On (Right)

Output Selection Matrix For Video Output 2 (3 BNCs)

The following table shows the combinations of DIP switch settings required to configure the three BNCs on the break-out cable.

Output Format	DIP Switch #1	DIP Switch #2	DIP Switch #3
1 composite & 1 Y/C (pedestal)	CMPSTE/ RIGHT	YPbPr/YC N/A	RIGHT
1 composite & 1 Y/C (no pedestal)	COMPNT/ RIGHT	YPbPr/YC/YC N/A	LEFT
RGB	COMPNT/ LEFT	RGB/RIGHT	LEFT
SMPTE component (BETA625)	COMPNT/ LEFT	YPbPr/YC/YC LEFT	LEFT
BETA 525 component	COMPNT/ LEFT	YPbPr/YC/YC LEFT	RIGHT

SMPTE Component

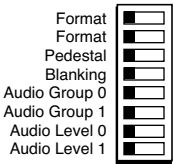

Selects:
Component
YPbPr (SMPTE)
Pedestal Off
Narrow Blanking
Audio Group 0 (channels 1-4)
Audio Level +4.00 dbu

Beta Component

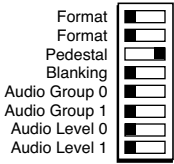

Selects:
Component
YPbPr (Beta)
Pedestal On
Narrow Blanking
Audio Group 0 (channels 1-4)
Audio Level +4.00 dbu

Composite

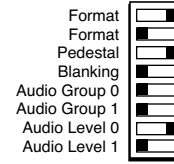

Selects:
Composite
Composite and Y/C
Pedestal On
Narrow Blanking
Audio Group 0 (channels 1-4)
Audio Level 0.00 dbu

Examples of Typical DIP Switch Settings

Installation

Typically, D10CEA installation consists of the following:

1. disconnect +5VDC from the convertor
2. configure the DIP switch for the desired equipment configuration and video formats
3. connect video equipment to the convertor BNCs
4. apply +5VDC power to the converter (AJA power supply model DWP)

Specifications

Item	Specification
Serial Input	SMPTE 259M with embedded audio, 1 BNC
Outputs	Video: YPbPr - SMPTE, EBU-N10, Betacam, RGB, NTSC, PAL, YC (S-Video), 10-bits 2 SDI Re-clocked loop-thru, 2 x BNC Audio: 4 Channel Balanced/Unbalanced. Audio breakout cable for balanced output included with unit. Video/Audio Outputs: 1 25-pin D connector
Audio Groups	1, 2, 3, 4
Frequency Response	+/- .25dB to 5.5MHz (Y Video) +/- .5dB to 20 KHz (Audio)
Audio Level Adjustments	-14, 0, +2, +4 dBu
Power (AJA power supply model DWP)	5v DC regulated, 4 watt
Size	5.8" x 3.1" x 1" (147 x 79 x 25 mm)