

**Model CK73041
Calibration Kit**



***CK73041
CALIBRATION KIT***

The POMONA CK73041 Calibration Kit includes the major connectors and test cables you need for instrument calibration in a comprehensive kit. Versatile adapters and flexible cables greatly expand the variety of test cables you can create, reducing the number of special-purpose patch cords and connectors needed for calibration applications.

**Test Equipment
Depot**

1-800-517-8431

99 Washington Street
Melrose, MA 02176
Phone 781-665-1400
Toll Free 1-800-517-8431

 Visit us at www.TestEquipmentDepot.com

 Back to the Pomona CK73041 Info Page

**Model CK73041
Calibration Kit**

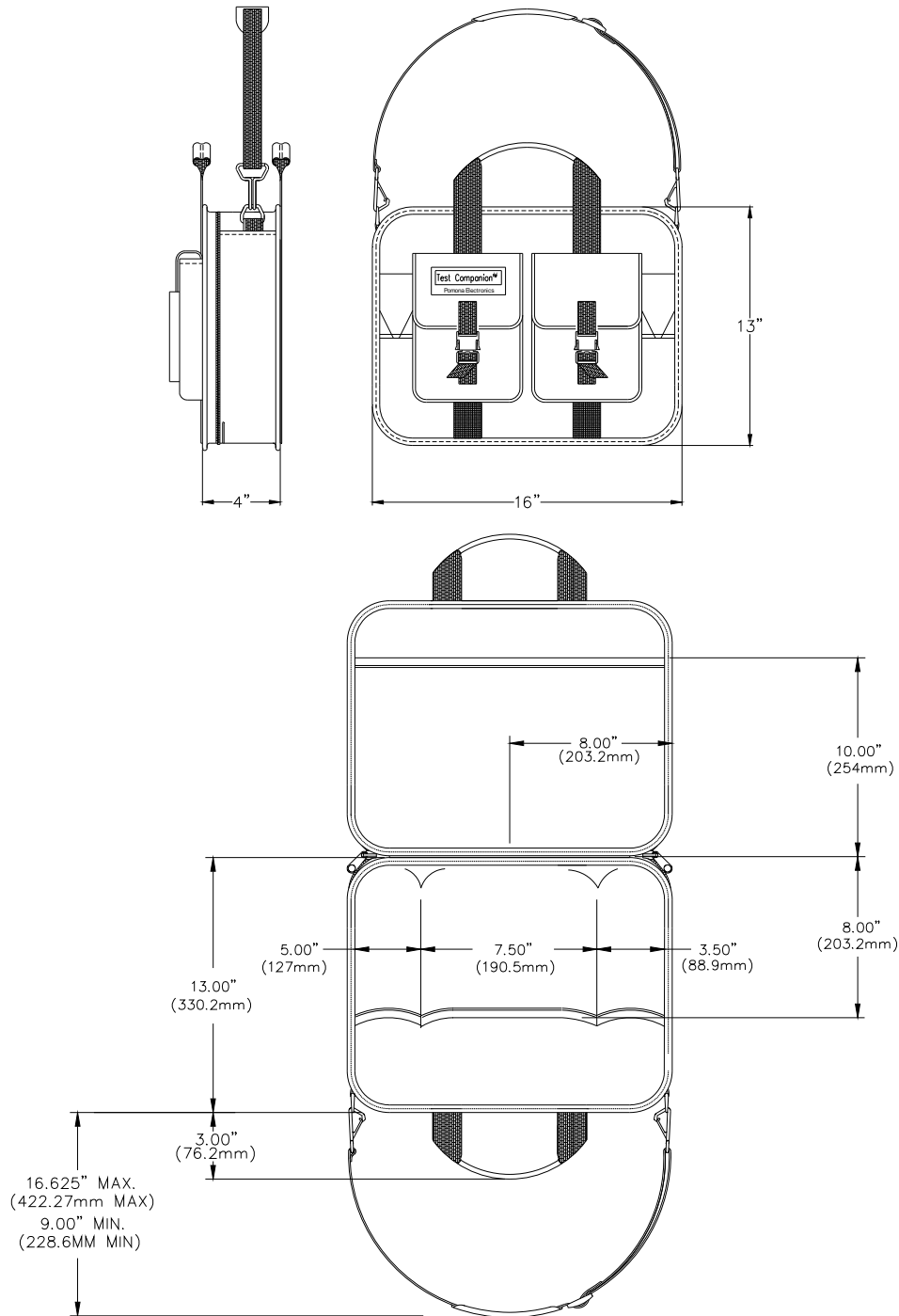

MODEL 6146
LARGE TEST COMPANION CARRYING CASE
QTY 1

All dimensions are in inches. Tolerances (except noted): .xx = ±.02" (.51 mm), .xxx = ±.005" (.127 mm). All specifications are to the latest revisions. Specifications are subject to change without notice. Registered trademarks are the property of their respective companies.

**Model CK73041
Calibration Kit**

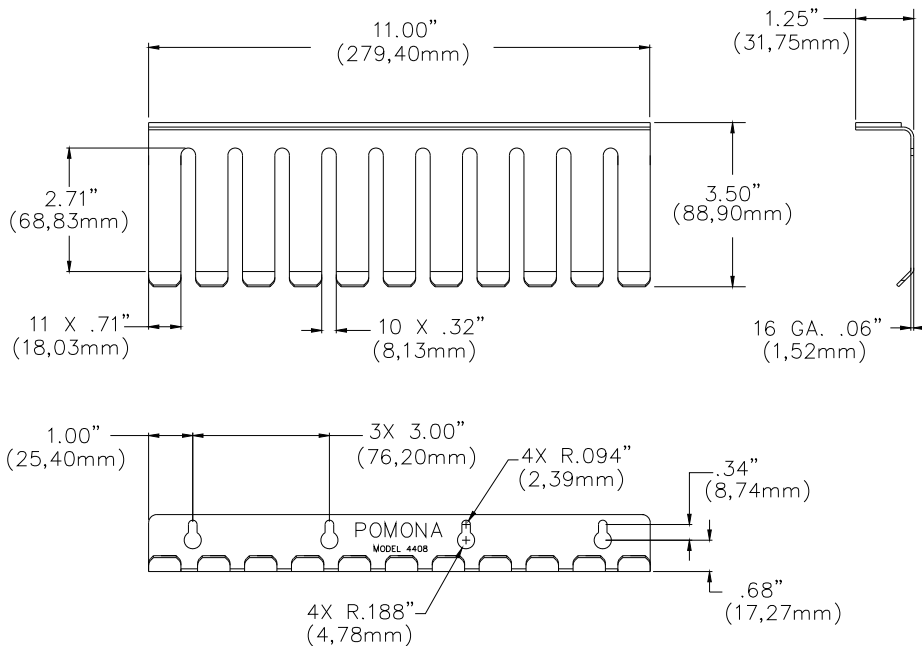

MODEL 4408
TEST LEAD HOLDER
QTY 1



MODEL HB-*
PATCH CORD SINGLE STACKING BANANA PLUG
QTY 4: 2 BLACK, 2 RED

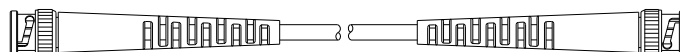

MODEL 2249
BNC (M), RG58C/U
QTY 4

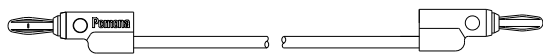

MODEL B-*
PATCH CORD SINGLE STACKING BANANA
QTY 8: 4 BLACK, 4 RED

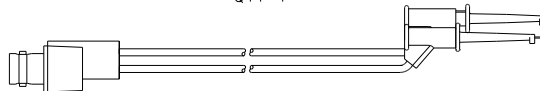

MODEL 5188
BREAKOUT BNC (F) TO MICROGRABBER
QTY 1:

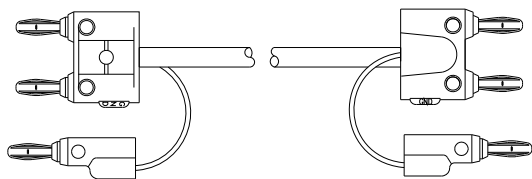

MODEL 1167
PATCH CORD DOUBLE BANANA PLUG
QTY 2

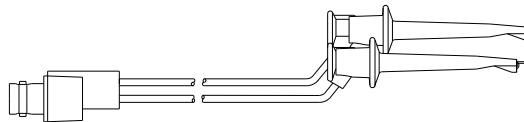

MODEL 3788
BREAKOUT BNC (F) TO MINIGRABBER
QTY 1:

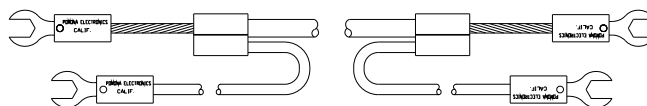

MODEL 1756
MICROVOLT SPADE LUG, SHIELDED
QTY 2

All dimensions are in inches. Tolerances (except noted): .xx = ±.02" (.51 mm), .xxx = ±.005" (.127 mm). All specifications are to the latest revisions. Specifications are subject to change without notice. Registered trademarks are the property of their respective companies.

**Model CK73041
Calibration Kit**

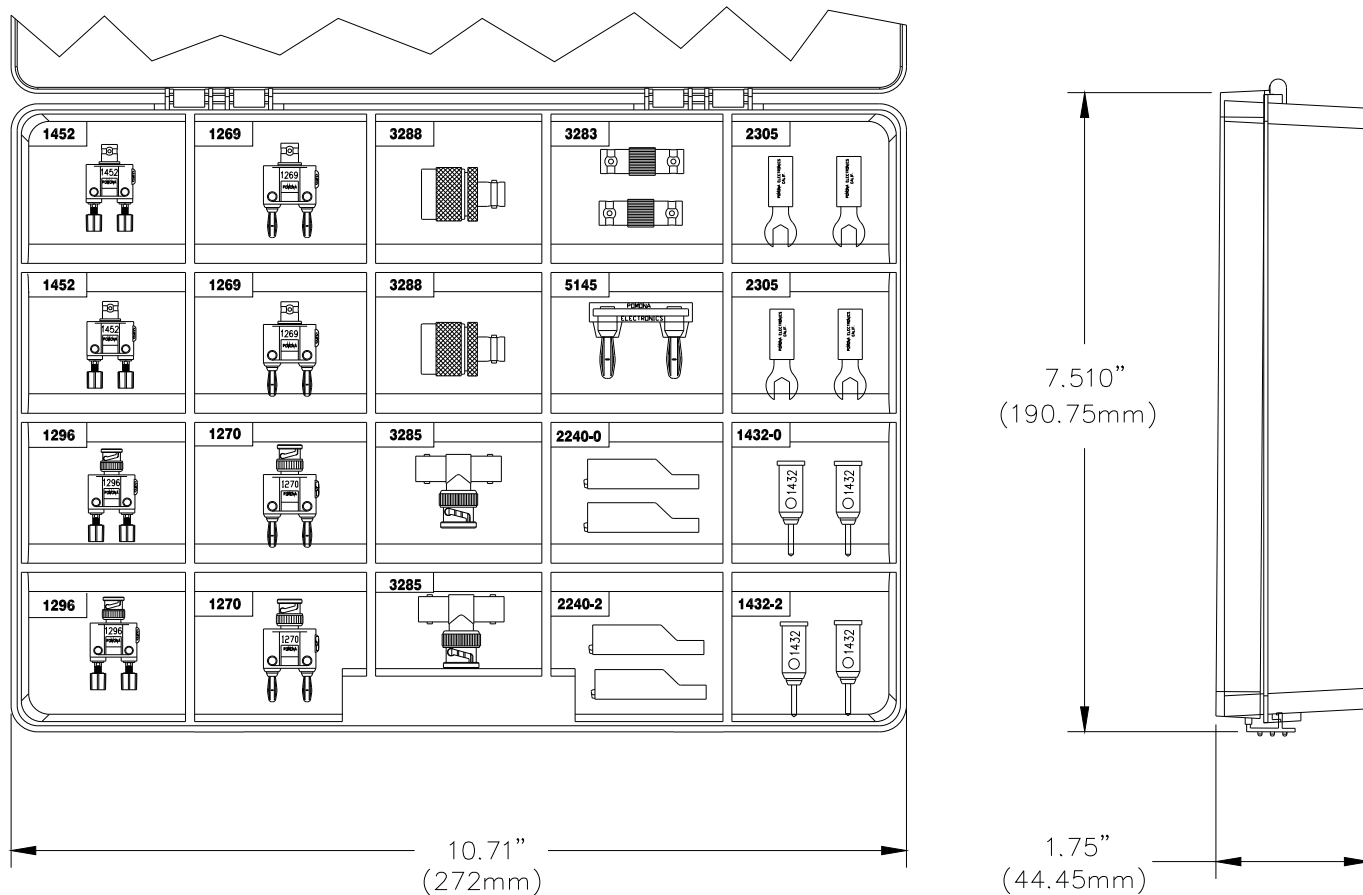

Features

- **Perfect for:**
 - Field Calibration
 - Outfitting a new technician or lab
 - Comprehensive replacement of important connectors and leads
- **The Calibration Kit allows you to:**
 - Combine connectors with patch cords to create a wide variety of necessary test cables.
 - Reduce the number of test cables needed by creating multiple combinations.
 - Make low voltage precision measurements with shielded low thermal EMF spade lug patch cords.
 - Easily connect to a variety of test equipment with BNC to banana and BNC to binding post adapters.
 - Use shielded coax cables for test and calibration rather than unshielded leads.
 - Turn banana plug patch cords into test leads terminated with alligator clips, spade lugs, or pin tips.
 - Access N Type instrument jacks.
 - Connect to analog components from coaxial cables.
 - Take advantage of shielded dual conductor patch cords.
 - Daisy-chain leads for those long lead situations.

All dimensions are in inches. Tolerances (except noted): .xx = ±.02" (.51 mm), .xxx = ±.005" (.127 mm). All specifications are to the latest revisions. Specifications are subject to change without notice. Registered trademarks are the property of their respective companies.

**Model CK73041
Calibration Kit**

- The **CK73041 CALIBRATION KIT** includes:

Item	Model	Description	Quantity
1	6146	LARGE TEST COMPANION CARRYING CASE	1
2	4408	TEST LEAD HOLDER	1
3	HB-36-0	HORIZONTAL STACKING BANANA PLUG PATCH CORD, 36 INCHES (914.4 mm), BLACK	2
4	HB-36-2	HORIZONTAL STACKING BANANA PLUG PATCH CORD, 36 INCHES (914.4 mm), RED	2
5	B-12-0	STACKING BANANA PLUG PATCH CORD, 12 INCHES (304.8 mm), BLACK	2
6	B-12-2	STACKING BANANA PLUG PATCH CORD, 12 INCHES (304.8 mm), RED	2
7	B-24-0	STACKING BANANA PLUG PATCH CORD, 24 INCHES (609.6 mm), BLACK	2
8	B-24-2	STACKING BANANA PLUG PATCH CORD, 24 INCHES (609.6 mm), RED	2
9	1167-36	DOUBLE BANANA PLUG ON SHIELDED BALANCE LINE, 36 INCHES (914.4 mm)	2
10	1756-48	SHIELDED LOW VOLTAGE SPADE LUG PATCH CORD, 48 INCHES (1219.2 mm)	2
11	2249-C-36	BNC (M) RG58C/U RF CABLE, 36 INCHES (914.4 mm)	4
12	5188	BNC (F) TO MICROGRABBER TEST CLIPS	1
13	3788	BNC (F) TO MINIGRABBER TEST CLIPS	1
14	1269	BNC (F) / DOUBLE BANANA PLUG ADAPTER	2
15	1270	BNC (M) / DOUBLE BANANA PLUG ADAPTER	2
16	1452	BNC (F) / DOUBLE BINDING POST ADAPTER	2
17	1296	BNC (M) / DOUBLE BINDING POST ADAPTER	2
18	2305	SET OF BLACK AND RED MICROVOLT SPADE LUG / BANANA JACK ADAPTER	2 (SETS)
19	2240-0	ALLIGATOR CLIP / BANANA JACK ADAPTER, BLACK	2*
20	2240-2	ALLIGATOR CLIP / BANANA JACK ADAPTER, RED	2*
21	1432-0	PIN TIP / BANANA JACK ADAPTER, BLACK	2*
22	1432-2	PIN TIP / BANANA JACK ADAPTER, RED	2*
23	3283	BNC (F-F) ADAPTER	2
24	3285	BNC (F-M-F) T ADAPTER	2
25	3288	BNC (F) / N TYPE (M) ADAPTER	2
26	5145	DOUBLE BANANA PLUG SHORTING BAR, INSULATED	1

* The model number refers to the standard item which is sold in 10 per package. However, the CK73041 contains only 2 pieces of the item.

Ordering Information

Model: **CK73041**
CALIBRATION KIT



99 Washington Street
Melrose, MA 02176
Phone 781-665-1400
Toll Free 1-800-517-8431

[Visit us at www.TestEquipmentDepot.com](http://www.TestEquipmentDepot.com)

[Back to the Pomona CK73041 Info Page](#)

Test Equipment Depot - 800.517.8431 - 99 Washington Street Melrose, MA 02176

FAX 781.665.0780 - TestEquipmentDepot.com